



# 2024 OPERATOR'S MANUAL



**Xplorer XRT 600 EPS  
Xplorer XRT 600 LE**

*This vehicle is not a toy. Never allow anyone under  
16 years of age to operate this ATV.*

# NOTE

Read this manual before you operate your ARGO ATV. It contains safe operating instructions and warns the user about potential hazards that can result in personal injury.

Warnings are identified in the text by the following symbol:



## WARNING

Warning text warns the user about potential hazards that can result in personal injury or death.

Cautions are identified in the text by the following symbol:



## CAUTION

Caution text contains cautions that can prevent damage to the ATV.

This manual is based on the latest product information available at the time of printing. ARGO reserves the right to make changes at any time and without obligation.

Reproduction of any part of this publication is prohibited without prior written permission.

© 2023 ARGO

**NOTE:** The machine you have purchased may differ slightly from those shown in the illustrations of this manual.



## WARNING

## CALIFORNIA PROPOSITION 65

**WARNING:** This product may contain fuels, oils and fluids, battery posts, terminals and related accessories which contain lead and lead compounds and other chemicals identified by the State of California to potentially cause cancer, birth defects, and other reproductive harm. These chemicals are found in vehicles, vehicle parts and accessories, both new and replacements. During maintenance, these vehicles generate used oil, waste fluids, grease, fumes and particulates, all identified by the State of California to potentially cause cancer, birth defects, and other reproductive harm.

For more information go to:

**[www.P65Warnings.ca.gov](http://www.P65Warnings.ca.gov)**

## PREFACE

This manual describes the controls, operation and basic maintenance procedures for the ARGO ATV from date of printing. Please take the time to read this manual carefully, for your safety and that of others. By following these instructions, you will ensure extended, trouble free operation of your ATV.

For maintenance and adjustment of the engine, refer to the manufacturer's operation and maintenance manual included in your ATV's information package.

Before you drive your ARGO ATV, make sure you understand how to use all controls, particularly the brakes and steering system. Learn how to drive your ATV in an open level area, away from buildings, trees and other obstacles, until you are completely familiar with its operating characteristics. Drive very slowly until your driving skills improve, and drive with caution and consideration at all times. The risk of accident or injury is greatest during the first weeks of use. Take special care during this period. ALWAYS RESPECT OUR ENVIRONMENT.

### **CAUTION TO THE ARGO OWNER/OPERATOR:**

Before you operate your new ATV, we highly recommend these important points:

- Read your Owner's Manual.
- Never allow anyone under 16 years of age to operate this ATV.
- Take the training course before operating your ATV, ask your dealer for more information.
- This ATV is designed for one operator or one operator and one passenger.
- This Operator's Manual is provided to make the operator aware of proper operating procedures. It also includes useful information related to general care and maintenance of your ATV.
- Prior to any ATV operation, it is absolutely essential to read and comprehend each section in this manual as well as watch the safety video provided with your ATV to develop an understanding of your ATV and to ensure your safety. After reviewing this manual and watching the safety video, store them in a dry and easily accessible place for future reference.
- This manual is designed to help familiarize you with safety, assembly and operation. Read this manual and follow the recommendations to help ensure safe and efficient operation.
- The information contained within this manual was current at the time of printing. Constant improvement in the design and quality of components may result in discrepancies between the actual ATV and information presented in this manual.
- To view the most up-to-date manuals or to order a replacement Operator's Manual, please contact an authorized dealer or visit the ARGO website.
- This manual has been prepared to instruct you in the safe and responsible operation of your ATV. Read and abide by all safety alert information about this ATV. If you do not understand any part of this manual, contact your local dealer for additional information and clarification. As the operator of this ATV, you are in complete control. Only you can prevent an accident from happening.
- Right-hand and left-hand, as used in this manual, are determined by facing the direction the ATV will travel while in use unless otherwise stated.
- Never modify the vehicle in any way that will alter the weight distribution of the vehicle, decrease its stability or increase the speed beyond the factory specifications. Such modifications can cause serious personal injury or death. The manufacturer prohibits and disclaims responsibility for any such modifications or any other alteration which would adversely affect the safety of the vehicle. The vehicle manufacturer reserves the right to incorporate engineering and design changes to products in this manual, without obligation to include these changes on units sold previously. The information contained in this manual may be revised periodically by the manufacturer, and therefore is subject to change without notice.

# TABLE OF CONTENTS

## **SECTION 1 - Introduction**

Introduction .....	1
Getting Acquainted With Your ATV .....	4

## **SECTION 2 - Safety Information**

Safety Information .....	7
Warnings .....	12
Hangtags and Warning Labels .....	21

## **SECTION 3 - Specifications**

Specifications .....	27
----------------------	----

## **SECTION 4 - Description and Identification**

Identification Number Records .....	29
Frame and Engine Serial Number .....	29
Location of Parts and Controls .....	30
Control Functions	
Ignition Switch .....	30
Signs and Functions .....	30
Engine Stop Switch .....	30
Headlight Switch .....	30
Starter Button .....	30
Over-ride Function .....	31
Brake Lever and Brake Pedal .....	31
Shift Lever .....	32
Drive Mode Select Buttons .....	33
Speedometer .....	36
Functions Display .....	37
Button Operations .....	38
Seat .....	39
Storage Compartments .....	39
Battery .....	40
Fuse Box .....	40
Auxiliary DC Jack .....	41
Throttle Lever .....	41
Speed Limiter .....	42
Air Cleaner .....	42
Tool Kit .....	43

## **SECTION 5 - Getting to Know Your ATV**

Getting to Know Your ATV .....	45
Weight Limits .....	45
Before Riding .....	45
Rider Preparation - Age Recommendation .....	45
Pre-Operation Checks .....	45
Safe Riding Rules .....	45
Protective Apparel .....	45
Accessories .....	46

No Modifications .....	46
For Off-Road Use Only .....	46
Exhaust System .....	46
Braking .....	47
Sliding or Skidding .....	47
Turning Your ATV .....	48
Climbing Uphill .....	48
Riding Downhill .....	49
Riding Over Rough Terrain .....	49
Crossing A Slope .....	50
Crossing Through Shallow Water .....	50
Parking .....	50
What To Do If .....	51

## **SECTION 6 - Before You Ride**

Engine Break-In .....	53
Pre-Operation Checks .....	53
Pre-Operation Check Table .....	54
Front and Rear Brakes .....	55
Fuel .....	55
Engine Oil .....	56
Front Differential Gear Oil .....	57
Rear Gearcase Gear Oil .....	57
Coolant .....	58
Tires .....	59
Tire Wear Limit .....	59
Throttle Lever .....	60
Lights .....	60
Switches .....	60
Fittings and Fasteners .....	60

## **SECTION 7 - Operation**

Mounting the ATV .....	61
Starting the Engine .....	62
Warming Up Engine .....	62
Braking / Stopping .....	62
Parking .....	63
Parking on a Slope .....	63
Turning Your ATV .....	63
Climbing Uphill .....	64
Riding Downhill .....	65
Crossing a Slope .....	66
Crossing Through Shallow Water .....	66
Riding Over Rough Terrain .....	67
Sliding and Skidding .....	67
Crossing Roads .....	67
Cold Weather Operation .....	68
Stopping the ATV .....	68
Stopping the Engine .....	68

## **SECTION 8 - General Maintenance**

General Maintenance .....	69
Maintenance Schedule .....	70
Jacking Point .....	71
Grease Point .....	71
Coolant Change .....	72
Spark Plug Inspection .....	73
Air Cleaner .....	74
Engine Oil and Filter .....	75
Front Differential Gear Oil .....	77
Rear Gearcase Gear Oil .....	78
Battery .....	79
Charging / Maintenance Charging .....	81
Jump Starting .....	81
Fuses .....	82
Replacing a Headlight Bulb .....	83
Adjusting Headlight Beam .....	84
Replacing Taillight/Brake Light Bulb .....	84
Shock Absorbers .....	85
Throttle Lever Adjustment .....	85
Cable Inspection and Lubrication .....	85
Front Brake Lever Free Play Adjustment .....	85
Brake Lever Lubrication .....	86
Brake Fluid Inspection .....	86
Wheel - Removal and Installation .....	87
Aftermarket Tires and Rims .....	88
Spark Arrester Cleaning .....	88
Noise Regulation .....	89
Troubleshooting .....	91

## **SECTION 9 - Preparation For Storage**

Cleaning the Vehicle .....	93
Short Term .....	94
Long Term .....	94

## **SECTION 10 - Warranty**

Limited Warranty .....	95
Warranty Coverage Period .....	95
Warranty Limitations and Exclusions .....	95
Warranty Procedure / Owner Responsibility .....	96
EPA Emissions Control System Warranty .....	97
Limited Warranties Emission Control Systems .....	97
Your Warranty Rights and Obligations .....	97
Owner's Responsibilities .....	97
Emissions Warranty Coverage .....	98
Warranted Parts .....	98
Maintenance Record .....	99

## NOTES

## SECTION 1

### Introduction

ARGO welcomes you to its growing family of new product owners. This All-Terrain Vehicle (ATV) has been designed with care and built by skilled workers using quality materials.

Proper setup, maintenance and safe operating practices will help you get years of satisfactory use from this ATV.

Your safety and the safety of all ARGO users is of the greatest concern to us. You will find numerous safety statements in this manual. Please read and follow them carefully. Always be safety conscious when you operate your ARGO and remember it is a motorized vehicle.

Please take the time to develop your driving skills before attempting new challenges. Observe the recommendations outlined in this Operator's Manual and remember; some things are just impossible, even with an ARGO.

***WELCOME TO THE WORLD WIDE ARGO FAMILY!***





# Introduction

Thank you for choosing this quality ARGO ATV. It has been designed and manufactured to provide you with reliable and enjoyable operation. This Owner's Manual should be considered a permanent part of your ATV and must remain with the ATV in the event of a resale.

This manual was prepared to provide you with the information required to operate and maintain your ATV. This manual also covers rider-related instructions, as well as service and storage instructions. If your ATV ever requires repair or service, contact an authorized ARGO ATV dealer for professional service.

As the owner and rider of an ARGO ATV, you should become thoroughly familiar with your ATVs basic operation, maintenance and storage procedures. Please read and understand the entire Owner's Manual before operating your ARGO ATV to ensure safe and proper use. Always operate your ATV within your level of skill and current terrain conditions.

At the time of publication, all of the information and illustrations in this manual are technically correct. Some illustrations herein are used to best represent a certain procedure or item and are not intended to depict actual conditions. Because ARGO is constantly refining and improving its products, there may be differences between the vehicle images and the text depicted in this manual and your ATV. As such, no retroactive obligation to the product is available.

## REPLACEMENT PARTS, ACCESSORIES and SERVICE

- Most replacement parts and accessories are typically available from your dealer. For immediate availability and convenience, it is recommended items be ordered from an authorized dealer. Take this manual and all supplements to the dealer when ordering parts in person.
- Orders may be subject to a minimum fee. A listing of authorized service providers in your area is also available on the website.
- Unapproved installation of parts or accessories can create a substantial safety hazard and increase the risk of personal injury.
- Use authorized parts only.

## Precautionary Measures

### *Protect Your Sport*

- Know all State and local laws relating to ATV riding,
- Respect your ATV
- Respect the environment, and
- You will gain the respect of other fellow riders.

**PLEASE TAKE A FEW MOMENTS TO GET ACQUAINTED WITH YOUR  
ATV BY READING THIS OWNER'S MANUAL**

**NOTE:**

The manufacturer **DISCLAIMS LIABILITY FOR ERRORS IN THIS MANUAL**, and **SPECIFICALLY DISCLAIMS LIABILITY FOR INCIDENTAL AND CONSEQUENTIAL DAMAGES** resulting from the use of the information and material in this manual.

Name: \_\_\_\_\_

Address: \_\_\_\_\_

Telephone: \_\_\_\_\_

Purchase Date (mm/dd/yyyy): \_\_\_\_\_

Model: \_\_\_\_\_

Frame Number: \_\_\_\_\_

Engine Number: \_\_\_\_\_

Key Number: \_\_\_\_\_

- Before operating this ATV, the owner and each operator must understand that this ATV was not designed or manufactured to meet specifications for use on public roads, streets, highways or thoroughfares.
- The owner and operator(s) must read and understand all the instructions for proper assembly and safe operation, as well as the instructions concerning the engine and all other portions of the ATV, as described and illustrated in this manual.
- This ATV is **NOT** to be operated by anyone under 16 years of age.
- This ATV is **NOT** a toy.
- Be sure to follow the recommended maintenance schedule and service your ATV accordingly.

**PREVENTATIVE MAINTENANCE IS EXTREMELY IMPORTANT TO  
THE SAFE OPERATION AND LONGEVITY OF YOUR ATV**

We advise you to follow the recommended maintenance program as outlined in this manual. This program is designed to ensure all critical components on this ATV are thoroughly inspected at specified intervals.

## GETTING ACQUAINTED WITH YOUR ATV

This manual will provide you with a good basic understanding of the features and operation of this ATV. This manual includes important safety information. It provides information about special techniques and skills necessary to ride the ATV. It also includes basic maintenance and inspection procedures. If you have any questions regarding the operation or maintenance of your ATV, please consult dealer.

### IMPORTANT SAFETY MESSAGE:

- The Consumer Product Safety Commission has concluded that ALL-TERRAIN VEHICLES (ATVs) may present a risk of DEATH or SEVERE INJURY in certain circumstances. While accidents may occur for many reasons:
    - As of September, 2021, the year 2018 is the most recent year of reporting for fatalities that CPSC considers complete. CPSC is aware of 1,591 people, including many children, have died in accidents associated with ATVs during a 3-year period from 2016 through 2018.
    - Many people have become severely paralyzed or suffered severe internal injuries as a result of accidents associated with ATVs.
    - Every month, thousands of people are treated in hospital emergency rooms for injuries received while riding an ATV.
  - **You should be aware that AN ATV IS NOT A TOY AND CAN BE HAZARDOUS TO OPERATE.** An ATV handles differently from other vehicles, including motorcycles and cars. A collision or rollover can occur quickly, even during routine maneuvers such as turning and driving on hills and over obstacles, if you fail to take proper precautions.
  - Read this manual carefully and completely before operating your ATV. Make sure you understand all instructions.
  - For Type 2 ATVs, Category G (General Use Model) ATV. An ATV intended for recreational and/or utility use by an operator age 16 or older.
  - Pay attention to the warning and notice labels on the ATV.
  - Never operate an ATV without proper training or instruction. For a training course, please consult a dealer or visit [argoxtv.com](http://argoxtv.com) for a link to RIDER SAFETY.
  - This ATV is designed for one operator or one operator and one passenger.
  - This ATV is designed exclusively for off-road use. It is not designed, properly equipped or licensed to be safely operated on public streets and highways.
  - This ATV complies with all applicable off-road noise level and spark arrester laws and regulations in effect at the time of manufacture.
  - Please check your local riding laws and regulations before operating this ATV.
  - For your safety, follow and understand all CAUTIONS, WARNINGS and LABELS contained in this Operator's Manual.
  - For your safety, watch the safety video provided with your ATV.
  - Keep this Operator's Manual with your ATV at all times for reference.
- FAILURE TO FOLLOW THE WARNINGS and CAUTIONS CONTAINED IN THIS MANUAL CAN RESULT IN SERIOUS INJURY OR DEATH.

### IMPORTANT

Operate this ATV with safety constantly in mind. Off-road vehicles face unpredictable and often hazardous terrain conditions. It is ultimately the operator's responsibility to handle the ATV safely within its limitations and to decide when and where to travel.

**FOR MORE INFORMATION ON OUR FULL PRODUCT OFFERING,  
VISIT OUR WEBSITE [www.argoxtv.com](http://www.argoxtv.com)**

- For a detailed description of warranty coverage for your ATV, refer to the Warranty section found in this Owner's Manual or visit our website.
- For a detailed description of the emissions warranty for your ATV, refer to the Emissions Warranty section of this Owner's Manual or visit our website.

***ARGO WANTS YOU TO BE SATISFIED WITH YOUR NEW ATV.  
IF YOU DO NOT UNDERSTAND ANY PART OF THIS MANUAL OR ARE NOT  
SATISFIED WITH THE SERVICE RECEIVED, PLEASE TAKE THE FOLLOWING  
ACTIONS:***

Discuss the matter with your dealership service manager. Make sure they are aware of any problems so they can assist you.



## **WARNING**

All engine exhaust contains carbon monoxide, a deadly gas. Carbon Monoxide is a colorless, odorless, tasteless gas, which may be present even if you do not see or smell any engine exhaust.

### **Avoid Carbon Monoxide Poisoning.**

- Do not run engine indoors. Even if you try to ventilate engine exhaust with fans or open windows and doors, carbon monoxide can rapidly reach dangerous levels.
- Do not run engine in poorly ventilated or partially enclosed areas such as barns, garages or carports.
- Do not run engine outdoors where engine exhaust can be drawn into a building through opening such as windows and doors.

## NOTES

## SECTION 2

### Safety Information

#### An ATV is NOT a Toy and Can Be Hazardous To Operate

An ATV handles differently from other vehicles such as motorcycles and cars. A collision or rollover can occur quickly, even during routine operation such as turning, driving over obstacles, on hills or rough terrain, if you do not take necessary precautions.

SEVERE INJURY OR DEATH can result if you do not follow these instructions:

- Read this manual and all CAUTION/WARNING labels carefully and follow the operating procedures described.
- Never operate an ATV without proper instruction. Take a training course. Beginners should receive training from a certified instructor. Contact the ATV Safety Institute at: U.S. - 1-800-887-2887 or Canada - 1-613-739-1535 to find out about a training course nearest you. Visit [www.atvsafety.org](http://www.atvsafety.org) to register for free ATV safety training. ARGO is offering a \$100 incentive for completion of the ASI approved safety training.
- \* FOR MORE INFORMATION ABOUT ATV SAFETY in the United States, call the Consumer Product Safety Commission at 1-800-638-2772 or visit [www.cpsc.gov](http://www.cpsc.gov) or visit [www.atvsafety.org](http://www.atvsafety.org).
- Never allow anyone under 16 years of age to operate this ATV.
- Never carry more than one passenger.
- Never permit a guest to operate this ATV unless the guest has read this manual and all product labels and has completed the training course.
- Never operate an ATV on any paved surfaces, including sidewalks, driveways, parking lots, and streets.
- Never operate this ATV on any public street, highway, or road (dirt or gravel).
- Never operate an ATV without wearing an approved helmet that fits properly. You should also wear eye protection (goggles or face shield), gloves, boots, long-sleeved shirt or jacket, and long pants.
- Never consume alcohol or drugs before or while operating this ATV.
- Never operate at excessive speeds. Always travel at a speed which is proper for the terrain, visibility and operating conditions, and your experience.
- Never attempt wheelies, jumps, or other stunts.
- Always inspect this ATV each time you use it to make sure it is in safe operating condition. Always follow the inspection, maintenance procedures and schedules described in this manual.
- Always keep both hands on the handlebars and both feet on the footrests of the ATV during operation.
- Always go slow and use caution when operating on unfamiliar terrain. Always be alert to changing terrain conditions when operating the ATV.
- Never operate the ATV on hills too steep for the abilities of the operator or the ATV. Practice on smaller hills before attempting larger hills.
- Never operate on excessively rough, slippery, or loose terrain.
- Always follow proper procedures for turning as described in this manual. Practice turning at slow speeds before attempting to turn at faster speeds. Do not turn at excessive speed.
- Always have the ATV inspected by an authorized ARGO dealer if it has been involved in any type of accident.
- NEVER OPERATE UP OR DOWN HILLS STEEPER THAN 25 DEGREES

## **An ATV is NOT a Toy and Can Be Hazardous To Operate**

- Always follow proper procedures for climbing hills as described in this manual. Check the terrain carefully before you start up any hill. Never climb hills with slippery or loose surfaces. Shift your weight forward. Never accelerate suddenly. Never go over the top of any hill at a high rate of speed.
- Always follow proper procedures for going down hills and for braking on hills as described in this manual. Check the terrain carefully before you start down any hill. Shift your weight towards the back of the ATV. Never go down a hill at a high rate of speed. Avoid going down a hill at an angle which would cause the ATV to lean sharply to one side. Go straight down the hill whenever possible.
- Always follow proper procedures for crossing the side of a hill as described in this manual. Avoid hills with slippery or loose surfaces. Shift your weight to the uphill side of the ATV. Never attempt to turn the ATV around on any hill until you have mastered the turning techniques described in this manual on level ground. Avoid crossing the side of a steep hill if possible.
- Always use proper procedures if you stall or roll backward when climbing a hill. To avoid stalling, maintain a steady speed when climbing a hill. If you stall or roll backwards, follow the special instructions for braking described in this manual. Dismount the ATV on the uphill side or to either side if pointed straight uphill. Turn the ATV around and mount the ATV following the special instructions described in this manual.
- Always check for obstacles before operating in a new area.
- Never attempt to operate over large obstacles, such as large rocks or fallen trees. Always follow proper procedures when operating over obstacles as described in this manual.
- Always use caution when skidding or sliding. On slippery surfaces, such as ice, go slow and be very cautious in order to reduce the chance of skidding or sliding out of control.
- Never operate an ATV in fast flowing water or in water deeper than the footrests. Remember that wet brakes may have reduced stopping capability. Test your brakes after exiting any water. If necessary, apply the brake lightly several times to let friction dry out the pads.
- Always use the size and type of tires specified in this manual.
- Always maintain proper tire pressure as described in this manual.
- Never improperly install or improperly use accessories on your ATV.
- Never exceed the stated load capacity for this ATV.

## An ATV is NOT a Toy and Can Be Hazardous To Operate

### IMPORTANT MESSAGE

**Your safety is very important to ARGO.** That is why we urge you to read this message before you operate this ATV. Off-road riding can be fun. However, an ATV is not a toy and it can be hazardous to operate. As with any activity involving speed and skill such as bicycling or skateboarding, poor judgment can result in injuries and we don't want that to happen! You can help prevent accidents by making good decisions about if, when, and how you ride this ATV.

### Evaluate Riding Readiness

The first decision you'll need to make is whether you're ready to ride. Riding readiness varies widely from one person to another, and while the minimum age for this ATV is 16 years of age, there are other factors that you should consider.

**Physical size and ability** are important considerations. To help determine whether a rider is big enough for this ATV, stand up on the footboards and grasp the hand grips. While holding this position, ensure you have at least three inches (8cm) of clearance between the ATV seat and the rider's "seat of the pants". At least three inches (8cm) of clearance is needed so you can stand up for balance and comfort, and to shift your body forward, backward and from side to side.

Also make sure you can comfortably reach and operate all the controls. For example, can you turn the handlebars all the way to the right and left? Can you operate the throttle and brake levers while holding onto the hand grips? If not, you are not physically ready to ride this ATV.

Before you operate an ATV, decide whether you are physically, mentally and emotionally ready to ride.

### Patience And Practice

Even if you take a certified training course, it's up to you to ensure your safety. Remember, learning to ride a ATV is a gradual step-by-step process. It takes time, patience and practice.

To help you regulate your rate of learning, your ATV was delivered with an **adjustable throttle limiter**. The limiter may be adjusted to reduce the maximum speed of the ATV. For adjustment and removal instructions, see page 29.





## **An ATV is NOT a Toy and Can Be Hazardous To Operate**

### **Always Supervise Inexperienced Riders**

Supervision is another important obligation of the owner. Even after riders become skilled off-road riders, it also helps to regularly remind all riders to follow the instructions and warnings in this manual. And remember, it's the owner's responsibility to see that the ATV is properly maintained and kept in safe operating condition.

If you choose to lend your ATV to another rider, make sure the rider is 16 years old or older and has completed the safety training course. You should understand that the decision to lend the ATV is yours.

### ***Use the below safety gear before operation:***

#### **Clothing and Gear**

While riding your ATV, you will find it important to dress correctly to prevent personal injury. Below is the minimum protection recommended to wear during every ride:

1. Helmet
2. Eye Protection
3. Long Pants
4. Long Sleeve Shirt
5. Gloves
6. Boots/Ankle Protection

#### **Helmet**

There are many different types and styles of helmet to choose from today. Be sure to choose a helmet that complies with the current standards of the U.S. Department of Transportation (DOT), The Snell Memorial Foundation, or the American National Standards Institute (ANSI). Helmets that comply with one or more of the above standards have a defined label located on the inside or outside of the helmet.

These helmets should provide full-face protection.

If you damage your helmet, obtain a new one immediately.

Remember: Your helmet is not providing any safety if the chin strap is not securely fastened.

#### **Eye Protection**

Wear eye protection, such as goggles, to completely surround your eyes to prevent any dirt or other items from getting into your eyes. Sunglasses are not a form of protection as they are open on the sides.

#### **Long Pants and Long Sleeve Shirt**

Protection from sticks, branches, long grass, airborne objects, or anything that could possibly scrape your skin. The heavier the material, the better the protection.

#### **Gloves**

Gloves will provide protection to your hands from any debris or incimate weather. Choose a glove that provides a gripping surface as well as protection.

## An ATV is NOT a Toy and Can Be Hazardous To Operate

### Boots/Ankle Protection

Choose a boot that protects the largest possible of your leg (preferable up to your knee) and can handle impact of rocks, dirt or branches. Choose a boot that has low heel and a good tread will help prevent your feet from slipping off the footrests in wet or rugged conditions.

### First Aid and Survival

Prepare for the unexpected. Emergencies and accidents happen and are ever worse when you are not prepared for them. Below is a recommended list of items you should have before every ride:

#### 1. Tools

Routine maintenance will generally eliminate the need for emergency repairs during your ride. Riding on rough terrain could cause some fasteners to loosen. Carrying the right tools can prevent down time. Below is a recommended list of tools to carry on your ride:

- a. Spark plug
- b. Spare parts
- c. Rope
- d. Tool kit
- e. Duct tape
- f. Headlight/Taillight bulbs

#### 2. Water

Water is an important part of your ride regardless of the duration. Heat exhaustion and heat stroke can suddenly shorten your ride. If you become dehydrated, you may find yourself unable to safely operate your ATV.

#### 3. Identification

If something happens to you while operating your ATV, emergency personnel will need to know who you are and who to call in the event of an emergency. It may be possible, you are unable to provide that information due to injury. Put identification in your pocket before you ride.

#### 4. First Aid Kit/ Emergency Kit with Flashlight

Several items are recommended in your Emergency Kit including a *Flashlight*; *Matches* in the event you need to start a fire; *Flares* for signaling help; *First Aid Kit* to include bandages, tape, gauze, antiseptic spray, etc. if an injury should occur; *Money*.

**5. Communication device** - it may be necessary to make an urgent phone call.

#### 6. Map/GPS

## Warnings



### **WARNING**

#### **POTENTIAL HAZARD**

Failure to follow the age recommendations for this ATV.

#### **WHAT CAN HAPPEN**

If children use ATVs that are not recommended for their age, severe injury or death can result.

Even though a child may be within the age group for which an ATV is recommended, he or she may not have the skills, abilities, or judgment needed to operate the ATV safely and may be involved in a serious accident.

#### **HOW TO AVOID THE HAZARD**

Never allow anyone under 16 years of age to operate this ATV.

Never allow continued use of the ATV if he or she does not have the abilities to operate it safely.



#### **POTENTIAL HAZARD**

Operating this vehicle without proper instruction.

#### **WHAT CAN HAPPEN**

The risk of an accident is greatly increased if the operator does not know how to operate this vehicle properly in different situations and on different types of terrain.

#### **HOW TO AVOID THE HAZARD**

All operators of this vehicle must read and understand this Operator's Manual and all warning and instruction labels prior to operating this vehicle.

#### **POTENTIAL HAZARD**

Operating this ATV on paved surfaces.

#### **WHAT CAN HAPPEN**

The ATV tires are designed for off-road use only and are not for use on pavement.

Paved surfaces may seriously affect the handling and control of the ATV and may cause the ATV to go out of control.

#### **HOW TO AVOID THE HAZARD**

Whenever possible, avoid operating the ATV on any paved surfaces including streets, parking lots, sidewalks, and driveways. If operating on paved surfaces is unavoidable, travel slowly (less than 10 mph) and avoid sudden turns and stops.



### **WARNING**

Indicates a potential hazard that could result in a serious injury or death.

## Warnings

### **POTENTIAL HAZARD**

Operating this ATV on public streets, roads, or highways.

### **WHAT CAN HAPPEN**

You can collide with another vehicle.

### **HOW TO AVOID THE HAZARD**

Never operate this ATV on any public street, road, or highway, even a dirt or gravel one. In many states it is illegal to operate an ATV on public streets, roads, or highways.



### **POTENTIAL HAZARD**

Operating this ATV after or while consuming alcohol or drugs.

### **WHAT CAN HAPPEN**

Can seriously affect your judgment.  
Can cause you to be slow to react.  
Can affect your balance and perception.  
Can result in an accident.

### **HOW TO AVOID THE HAZARD**

Never consume alcohol or drugs before or while operating this ATV.



### **POTENTIAL HAZARD**

Failure to inspect the ATV before operation.  
Failure to properly maintain the ATV.

### **WHAT CAN HAPPEN**

Increases the possibility of an accident or equipment damage.

### **HOW TO AVOID THE HAZARD**

Always inspect the ATV every time you use it. Ensure it is safe operating condition.  
Always follow the inspection and maintenance procedures and schedules described in this Operator's Manual.

### **POTENTIAL HAZARD**

Operating this ATV at excessive speeds.

### **WHAT CAN HAPPEN**

Increases the chance of losing control of the ATV, which can result in an accident.

### **HOW TO AVOID THE HAZARD**

Always operate at a speed that is proper for the terrain, visibility, operating conditions, and your age and experience.



## **WARNING**

Indicates a potential hazard that could result in a serious injury or death.

# Warnings

## **POTENTIAL HAZARD**

Operating this ATV without wearing an approved motorcycle helmet, eye protection, and protective clothing.

## **WHAT CAN HAPPEN**

Operating without an approved helmet increases your chances of a severe head injury or death in the event of an accident.

Operating without eye protection can result in an accident and increases your chances of a severe injury in the event of an accident.

Operating without protective clothing increases your chances of severe injury in the event of an accident.

## **HOW TO AVOID THE HAZARD**

Always wear an approved helmet that fits properly.

You should also wear:

Eye protection (goggles or face shield)

Gloves

Boots

Long sleeved shirt or jacket

Long pants

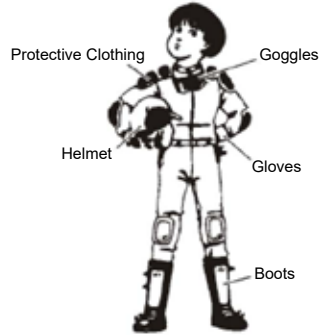

## **POTENTIAL HAZARD**

Failure to use caution when operating this ATV on unfamiliar terrain.

## **WHAT CAN HAPPEN**

You may encounter hidden rocks, bumps, or holes without enough time to react.

Could result in the ATV going out of control.

## **HOW TO AVOID THE HAZARD**

Use caution when operating on unfamiliar terrain. Always be alert to changing terrain conditions.



## **POTENTIAL HAZARD**

Failure to use caution in turns; turning too sharp or aggressive.

## **WHAT CAN HAPPEN**

You may lose control, which could result in an accident.

## **HOW TO AVOID THE HAZARD**

Always follow proper procedure for turning. Practice turning at slower speeds before attempting to turn at faster speeds. Do not attempt to turn at excessive speeds or too sharp for the conditions and for your experience level.



**WARNING**

Indicates a potential hazard that could result in a serious injury or death.

## Warnings

### POTENTIAL HAZARD

Attempting wheelies, jumps and other stunts.

### WHAT CAN HAPPEN

Increases the chance of losing control of the ATV, which can result in an accident.

### HOW TO AVOID THE HAZARD

Never attempt stunts, such as wheelies or jumps. Don't try to show off.

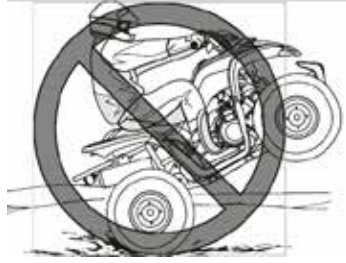

### POTENTIAL HAZARD

Failing to keep hands on handlebars or feet on footrests during operation.

### WHAT CAN HAPPEN

Removing even one hand or foot can reduce your ability to control the ATV or could cause you to lose your balance and fall off the ATV. If you remove a foot from the footrest, your foot or leg may come into contact with the wheels, which could cause personal injury or cause an accident.

### HOW TO AVOID THE HAZARD

Always keep both hands on the handlebars and both feet on the footrests during operation.



### POTENTIAL HAZARD

Improper handling of gasoline.

### WHAT CAN HAPPEN

Gasoline can ignite and you could be burned. Gasoline is poisonous and can cause injury.

### HOW TO AVOID THE HAZARD

Always turn off the engine when refueling.  
Do not refuel right after the engine has been running and is still very hot.  
Do not spill gasoline on the engine or exhaust pipe/muffler when refueling.  
Never refuel while smoking, or while in the vicinity of sparks, open flames, or other sources of ignition such as the pilot lights of water heaters and clothes dryers.  
When transporting the machine in another vehicle, be sure it is kept upright and that the fuel cock is in the "OFF" position.  
Otherwise, fuel may leak out of the carburetor or fuel tank.

**Never Operate Up or Down Hills  
Steeper than 25°**

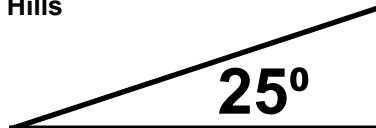

**WARNING**

Indicates a potential hazard that could result in a serious injury or death.

# Warnings

## **POTENTIAL HAZARD**

Operating on steep hills.

## **WHAT CAN HAPPEN**

This ATV can overturn more easily on steep hills than on level surfaces.

## **HOW TO AVOID THE HAZARD**

Never operate this ATV on hills too steep for the ATV or for your abilities.  
Practice on smaller hills before attempting larger hills.

## **POTENTIAL HAZARD**

Failure to use caution when operating this ATV on rough, slippery, or loose terrain.

## **WHAT CAN HAPPEN**

You may lose traction or control, which could result in an accident.

## **HOW TO AVOID THE HAZARD**

Do not operate this ATV on rough, slippery, or loose terrain until you have learned and practiced the skills necessary to control this ATV on such terrain.



## **POTENTIAL HAZARD**

Climbing hills improperly.

## **WHAT CAN HAPPEN**

You may lose control, which could result in an accident.

## **HOW TO AVOID THE HAZARD**

Always follow proper procedures for climbing hills.  
Always check the terrain carefully before you start up any hill.  
Never climb hills with slippery or loose surfaces.  
Shift your weight forward.  
Never open the throttle suddenly. The ATV may flip over backwards.  
Never go over the top of any hill at high speeds. An obstacle, sharp drop, or another vehicle or person may be on the other side.



## **POTENTIAL HAZARD**

Skidding or sliding.

## **WHAT CAN HAPPEN**

You may lose control, which could result in an accident.

## **HOW TO AVOID THE HAZARD**

Learn to safely control skidding or sliding by practicing at slow speeds on level, smooth terrain.  
On extremely slippery surfaces, such as ice or snow, go slow and use caution in order to reduce the chance of skidding or sliding out of control..



**WARNING**

Indicates a potential hazard that could result in a serious injury or death.

## Warnings

### **POTENTIAL HAZARD**

Going down a hill improperly.

### **WHAT CAN HAPPEN**

You may lose control, which could result in an accident.

### **HOW TO AVOID THE HAZARD**

Always follow proper procedures for going down hills.

Always check the terrain carefully before you start down any hill.

Shift your weight backward.

Never go down a hill at high speeds.

Avoid going down a hill at an angle that would cause the ATV to lean sharply to one side. Go straight down the hill where possible.

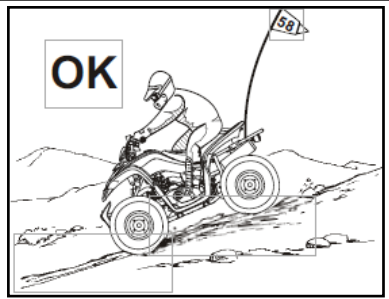

### **POTENTIAL HAZARD**

Stalling, rolling backwards, or improperly dismounting while climbing a hill.

### **WHAT CAN HAPPEN**

You may lose control, which could result in an accident.

### **HOW TO AVOID THE HAZARD**

Use proper gear and maintain steady speed when climbing a hill.

If you lose all forward momentum:

Keep weight uphill.

Apply the brakes.

Engage the parking brake after you are stopped.

If you begin rolling backwards:

Keep weight uphill.

Gradually apply the brakes while rolling backwards.

When fully stopped, engage the parking brake.

Dismount on the uphill side or to a side if pointed straight uphill.

Turn the ATV around and mount following the procedure described in this Operator's Manual.

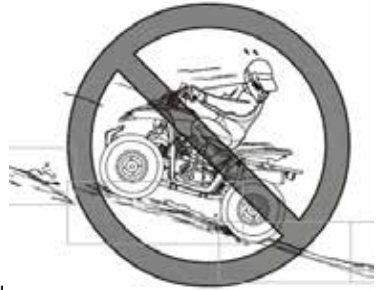

### **POTENTIAL HAZARD**

Operating the ATV with improper tires or improper or uneven tire pressure.

### **WHAT CAN HAPPEN**

You may lose control, which could result in an accident.

### **HOW TO AVOID THE HAZARD**

Always use the size and type of tires specified in this Operator's Manual.

Always maintain proper tire pressure.



## **WARNING**

Indicates a potential hazard that could result in a serious injury or death.



## Warnings

### **POTENTIAL HAZARD**

Operating the ATV in deep or fast flowing water.

### **WHAT CAN HAPPEN**

Tires may float, causing loss of traction and loss of control, which could result in an accident.

### **HOW TO AVOID THE HAZARD**

Never operate the ATV in fast flowing water or in water deeper than the footrests.

Remember that wet brakes may have reduced stopping capability.

Test the brakes after exiting the water. If necessary, apply the brakes several times to dry out the brake pads.



### **POTENTIAL HAZARD**

Operating this ATV with improper modifications.

### **WHAT CAN HAPPEN**

Improper installation and improper use of accessories or modification of the ATV may cause changes in operation or handling which, in some situations, may lead to an accident.

### **HOW TO AVOID THE HAZARD**

Never modify this ATV through improper installation or improper use of accessories.

All parts and accessories added to this ATV should be components designed for use on this ATV and should be installed and used according to instructions.

Never install a twist grip throttle. If you have questions, please contact an authorized dealer.

### **POTENTIAL HAZARD**

Improperly operating over obstacles.

### **WHAT CAN HAPPEN**

You may lose control, which could result in an accident.

### **HOW TO AVOID THE HAZARD**

Before operating on unfamiliar terrain, check for obstacles.

Never attempt to operate over large obstacles, such as large rocks or fallen trees.

When going over obstacles, always follow proper procedures.

### **POTENTIAL HAZARD**

Operating the ATV with more passengers than designed.

### **WHAT CAN HAPPEN**

You may lose control, which could result in an accident.

### **HOW TO AVOID THE HAZARD**

Never operate with a passenger unless the vehicle is equipped with a passenger seat (2-up model).



## **WARNING**

Indicates a potential hazard that could result in a serious injury or death.

# Warnings

## **POTENTIAL HAZARD**

Failure to release the parking brake before operating the ATV.

## **WHAT CAN HAPPEN**

Operating the ATV with the parking brake engaged could cause a change in handling or loss of brakes and cause an accident.

## **HOW TO AVOID THE HAZARD**

Always release the parking brake before operating the ATV.

## **POTENTIAL HAZARD**

Improperly crossing hills or turning on hills.

## **WHAT CAN HAPPEN**

You may lose control, which could result in an accident.

## **HOW TO AVOID THE HAZARD**

Avoid crossing the side of a hill or turning on a hill whenever possible. Never attempt to turn the ATV around on any hill until you have mastered the turning technique as described in this Operator's Manual. Practice first on level ground.

If you must cross the side of a hill or turn on a hill: Always follow proper procedures described in this Operator's Manual.

Avoid hills with slippery or loose surfaces.

Shift your weight to the uphill side of the ATV.



## **POTENTIAL HAZARD**

Starting or running engine in a closed area.

## **WHAT CAN HAPPEN**

Exhaust fumes are poisonous and may cause loss of consciousness and death within a short period of time.

## **HOW TO AVOID THE HAZARD**

Always operate your ATV outdoors or in an area with adequate ventilation.

## **POTENTIAL HAZARD**

Hot exhaust system.

## **WHAT CAN HAPPEN**

Someone coming in contact with the exhaust system during or after operation could be burned.

## **HOW TO AVOID THE HAZARD**

Do not touch the hot exhaust system.

Do not park the ATV in a place where others might be likely to come in contact with the exhaust system.

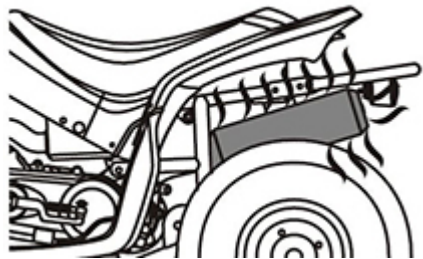

## **WARNING**

Indicates a potential hazard that could result in a serious injury or death.

## Warnings

### **POTENTIAL HAZARD**

Operating in areas where you might not be seen by other off-road ATVs.

### **WHAT CAN HAPPEN**

You may be in a collision which may result in personal injury.

### **HOW TO AVOID THE HAZARD**

Always mount a caution flag on the ATV to make you more visible.  
Watch carefully for other ATV riders and other vehicles.



### **POTENTIAL HAZARD**

Turning improperly.

### **WHAT CAN HAPPEN**

ATV could go out of control, causing a collision or overturn.

### **HOW TO AVOID THE HAZARD**

Always follow proper procedures for turning as described in this Owner's Manual.  
Practice turning at low speeds before attempting to turn at faster speeds. Do not turn at speeds too fast for your skills or the conditions.  
Do not turn at excessive speeds.

### **POTENTIAL HAZARD**

Overloading this ATV.

### **WHAT CAN HAPPEN**

Could cause changes in ATV handling, stability and braking which could lead to an accident or injury.

### **HOW TO AVOID THE HAZARD**

Never exceed the stated maximum weight capacity for this ATV.



## **WARNING**

Indicates a potential hazard that could result in a serious injury or death.

## Hangtags and Warning Labels

Your ARGO ATV comes with various hangtags and several labels containing important safety information related to the vehicle. Anyone who operates the ATV should read and understand the important safety information before operating.

The hangtags and labels are considered to be a permanent part of the ATV. If a label becomes hard to read or comes off the vehicle, contact your ARGO ATV dealer for a replacement.



**Emissions Control Information**

Manufacture: ARGO  
 Engine Displacement: \_\_\_\_\_ Engine Family: \_\_\_\_\_  
 UTV Permeation Family: \_\_\_\_\_

This Vehicle conforms to EPA regulations applicable \_\_\_\_\_ model year new UTVs and is certified to EPA emission standards of \_\_\_\_\_ g/km HC + NOX and \_\_\_\_\_ g/km CO

**ENGINE TUNE UP SPECS**  
 Ignition Timing: \_\_\_\_\_

Certified to use Gasoline  
 Minimum Unleaded Fuel Octane Rating: \_\_\_\_\_  
 Engine Exhaust Control System: \_\_\_\_\_

Made in TAIWAN  
 Date of Manufacture: \_\_\_\_/\_\_\_\_/\_\_\_\_



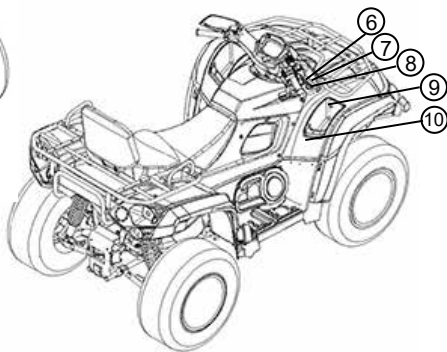
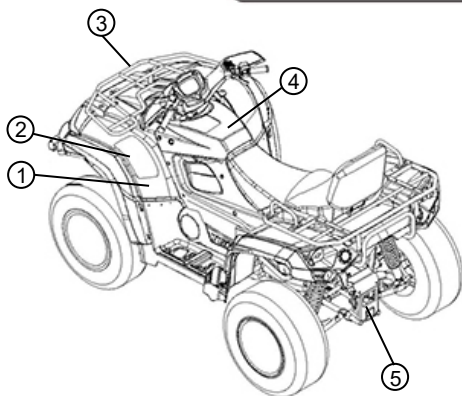

## Hangtags and Warning Labels

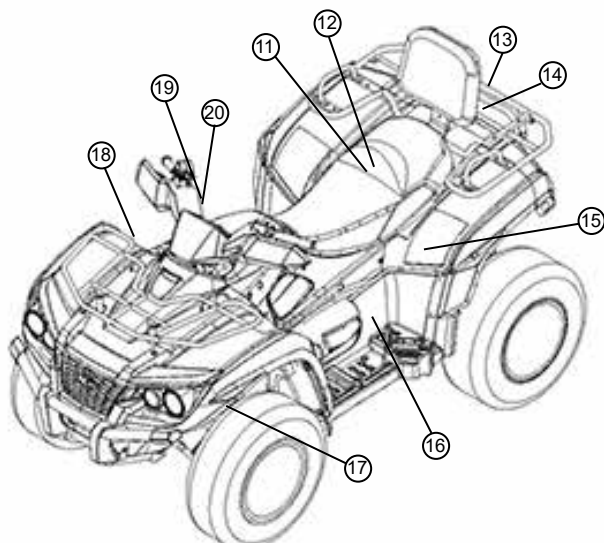

Read and understand all of the labels on your ATV. These labels contain important information for safe and proper operation.

Never remove any labels from your ATV. If a label becomes difficult to read or comes off, request a replacement label from your dealer.

1.

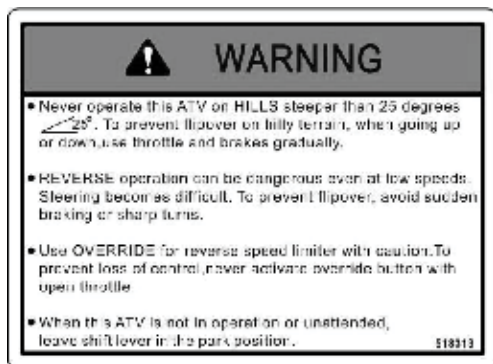

2.



## Hangtags and Warning Labels

3.



4.



5.



6.

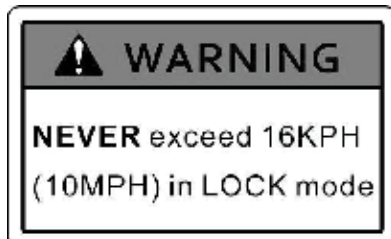

7.

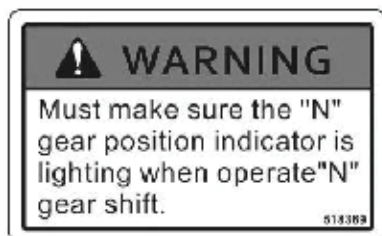

8.



9.



10.



## Hangtags and Warning Labels

11.

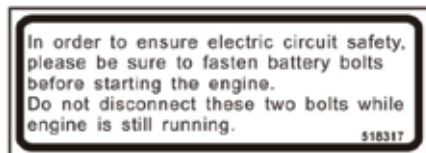

12.

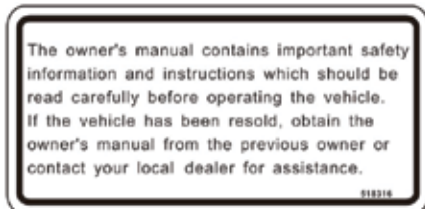

13.



14.



15.



16.



17.

Manufactured by Taiwan Golden Bee (TGB). Taiwan Golden Bee (TGB) certifies that this ATV complies with ANSI/SVIA 1-2017 Standard, and is subject to the ARGO USA, Inc. Action Plan on file with the U.S. Consumer Product Safety Commission.

18.

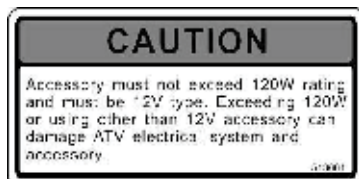

## Hangtags and Warning Labels

19.

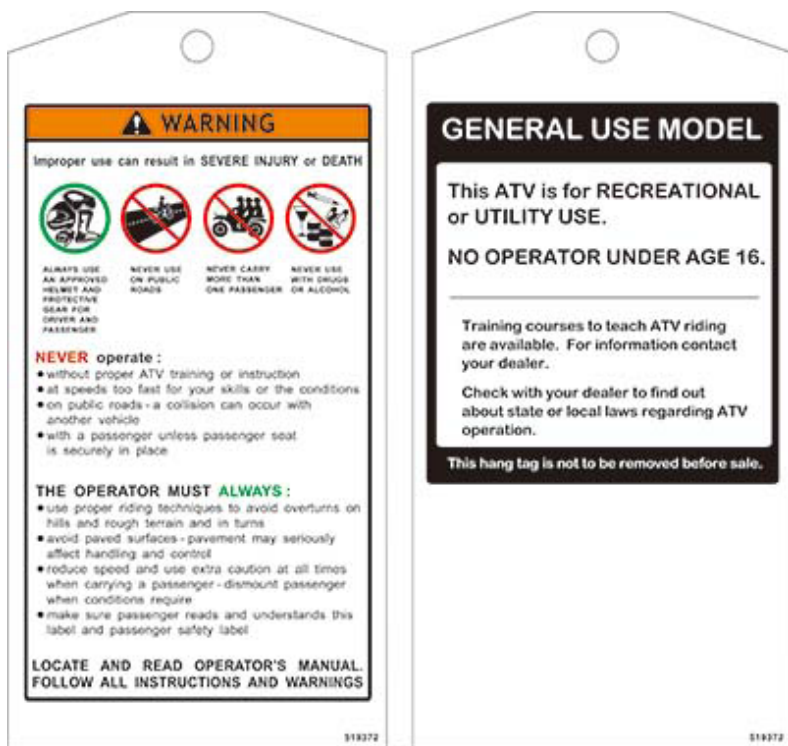

Front

Back

20.

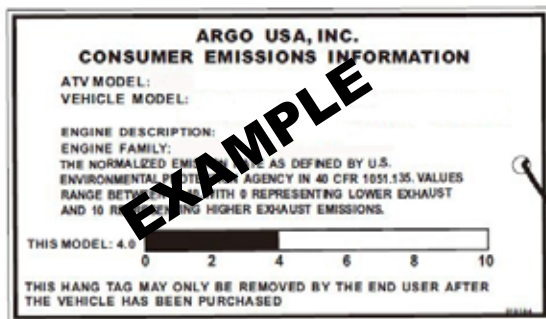



## NOTES

## SECTION 3

### Specifications

ENGINE AND DRIVE	
Type	Four-Stroke, Water Cooled
Bore x Stroke	95 x 79.2 mm (3.74 x 3.12 in.)
Displacement	561 cc
Cylinder arrangement	Single cylinder
Compression ratio	10.2 +/-0.5
Max. Power / RPM	31.4 kw / 7000 rpm
Max. Torque / RPM	53.6 Nm / 5500 rpm
Ignition	ECU
Starting system	Electric
Lubrication system	Forced circulation and splash
Spark Plug Type	NGK DCR8E
Battery	12V / 18 AH
Air Filtration	Sponge
Brake Type	Front Disk - 200 mm (7.8 in) Rear Disk - 180 mm (7.08 in)
Primary Reduction	Belt
Secondary Reduction	Gear / Sprocket
Clutch type	Centrifugal, dry type
Transmission	C.V.T., auto speed change
CHASSIS	
Length (Overall)	89.8 in (228 cm)
Height (Overall)	55.9 in (142 cm)
Width (Overall)	48.4 in (123 cm)
Dry Weight	851 lb (387 kg)
Wheel base	57.1 in (1450 mm)
Suspension	Front: Double A-arm Rear: Double A-arm
Tires	Type: Tubeless XRT 600 EPS Front: 25x8-12 Rear: 25x10-12 XRT 600 LE Front: 26x9-14 Rear: 26x11-14
Tire Pressure	Front: 7 psi (48 kPa) Rear: 7 psi (48 kPa)

**MISCELLANEOUS**

Rims	XRT 600 EPS: Steel XRT 600 LE: Aluminum
Gas Tank Capacity (Rated)	4.2 gal (16 L)
Gasoline (Recommended)	87 Octane Regular Unleaded
Engine Oil (Recommended)	SAE 10W-40
Engine Oil Capacity (Approximate)	Change w/Filter - 4 qt (3.85 L) Change w/o Filter - 3.6 qt (3.5 L)
Gear Lubricant (Recommended)	SAE 85W-90
Front Differential	Change: 11.8 oz (350 ml) Rebuild: 13.53 oz (400 ml)
Rear Gearcase	Change: 11.8 oz (350 ml) Rebuild: 13.53 oz (400 ml)
Lamps	Front - 60 x 2W (HI/LO) - 60 x 2W Rear Lamps - 5 x 1W Brake Lamps - 21 x 1W Turn Lamps - 10 x 4W
Weight Limits	
Load Capacity (Maximum)	508 lb (230 kg)
Front Rack (Maximum)	99 lb (45 kg)
Rear Rack (Maximum)	165 lb (75 kg)
Hitch Max. Vertical Weight	120 lb (55 kg)
Towing Capacity	1225 lb (557 kg)
Specifications subject to change without notice.	

## SECTION 4

### Description and Identification

#### Identification Number Records

Record the key identification number, frame serial number, engine serial number and model code information for assistance when order replacement parts.

KEY NO. \_\_\_\_\_

FRAME NO. \_\_\_\_\_

ENGINE NO. \_\_\_\_\_

MODEL CODE \_\_\_\_\_



#### Key identification number

The key identification number is stamped on the hang tag as shown in the illustration.

#### Frame and Engine Serial Number

1. Frame Number:  
Record chassis and engine number for future reference.  
Number is located front right hand side of chassis as shown in (1).
2. Engine number is located front of the engine as shown in (2).

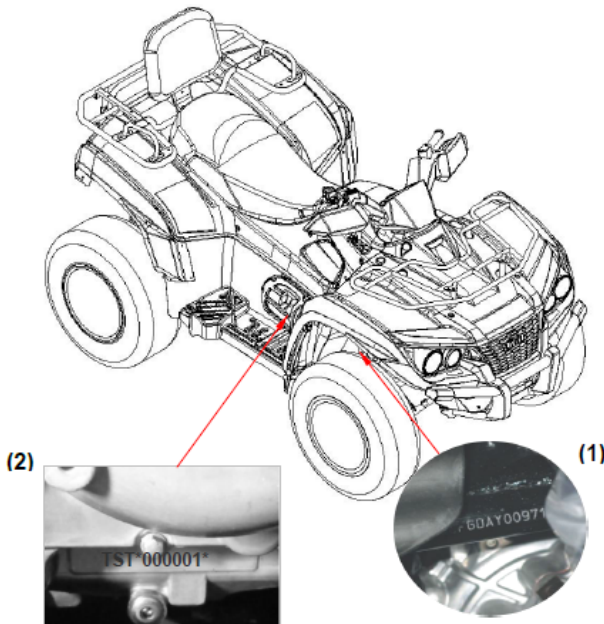



## Location of Parts and Controls



- |   |   |
|---|---|
| <ul style="list-style-type: none"> <li>1. Stop switch</li> <li>2. High/Low beam switch</li> <li>3. Four wheel brake lever</li> <li>4. Starter switch</li> <li>5. Override switch</li> <li>6. Ignition switch</li> <li>7. Speedometer &amp; Display</li> </ul> | <ul style="list-style-type: none"> <li>8. Auxiliary DC jack</li> <li>9. 2WD/4WD/LOCK switch</li> <li>10. Throttle</li> <li>11. Fuel Tank Cap</li> <li>12. L/H/N/R Lever</li> <li>13. Parking Brake</li> </ul> |
|---|---|

### Ignition Switch Function / Position

Position	Function	Key Out
	Position Lamp	NO
<b>ON</b>	All electrical systems operational	NO
<b>OFF</b>	While parking	YES









### CAUTION

Always leave the ignition switch in the “OFF” position when the engine is not running. Leaving the ignition switch in the “ON” position when the engine is not running may cause the battery to discharge.

If you stop your ATV by turning the engine stop switch to the “OFF” position, be sure to turn the ignition switch to the “OFF” position to prevent battery discharge.

### Signs and Functions

Position	Name	Function
	Starter Switch	Start engine
	Dimmer Switch	Hi-Beam/Lo-Beam Switch
	Engine Stop Switch	Engine stop
	Run Engine	Engage the engine to run



**Note:** To start the engine, brake must be applied.

## Location of Parts and Controls

### Over-ride Function

1. Set the gear shift lever in the Reverse "R" position then press and hold the over-ride button.
2. When pressure on the button is released, reverse gear speed will be limited.

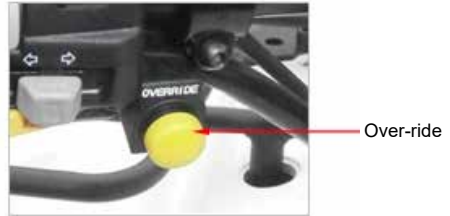

### Four-Wheel Brake Lever (with Parking Brake)

The four wheel brake lever is located on the left handlebar. To apply the brake, pull the brake lever toward the handlebar grip.



### Rear Brake Pedal

The rear brake (pedal) is located on the right side of the ATV. To apply the rear brake, push down on the brake pedal.



### WARNING

- Before operating, check whether there is appropriate resistance on the brake at the brake lever. Also check there is sufficient quantity of brake fluid in the reservoir.
- Before operating, check the brake system. The gap of the brake lever end should be 12 mm approximately. Inform your local dealer of possible deviations.
- Irregularities of brakes such as leaks and poor performance should be inspected by an authorized ARGO dealer.

**Note:** By squeezing the brake lever, the four-wheel brake system will activate.

**Note:** The brake fluid level must be above the MIN mark. If the level keeps going down, see an authorized ARGO dealer. Always use DOT 4 brake fluid.

## Location of Parts and Controls



### Shift Lever

**L:** High torque use (advance gear)

**H:** Normal use (driving gear)

**N:** Neutral

**R:** Reverse use

**P:** Parking use

### Shift lever instructions:

1. Engine starts in the Neutral (N) or the Park (P) positions.
2. Lift up and hold the pull rod of shift lever to disengage and move the shift lever from “N” to “H”, “L” or “R”. (“L” is used for rough surfaces).



**Note:** When shifting from H to L and any gear/direction, the vehicle must be at a complete stop.

3. For reverse, with the brake applied, push the knob in and move the shift lever from “N” to “R”.



### **CAUTION**

Operating the shift lever while vehicle is in motion can be hazardous. This is strictly prohibited. Always wait until the vehicle is completely stopped. Do not operate the ATV at high speeds in “R” (reverse) under any circumstances.

## Location of Parts and Controls

### **2WD / 4WD / Lock Selector**

#### **Switch**

The 2WD/4WD selector switch allows you to operate your ATV in either two-wheel drive (rear wheels powered) or four-wheel drive (open front differential).

The 2WD/4WD/LOCK select switch is located above the throttle lever. To select the LOCK mode, depress the 4WD switch and rotate the LOCK lever "UP" to the LOCK position. Present drive mode is displayed on the multi-functional gauge. To disengage power to the front wheels, rotate the LOCK lever "DOWN" and depress the 2WD/4WD switch.



### **WARNING**

Always stop the ATV before changing from two-wheel drive to four-wheel drive and vice versa as damage to the differential may occur. The ATV handles differently in two-wheel drive than in four-wheel drive in some circumstances. Changing from the two-wheel drive to four-wheel drive or vice versa while moving may cause the ATV to unexpectedly handle differently. This could distract the operator and increase the risk of losing control and causing an accident.



## Location of Parts and Controls

### **2WD: Rear Wheel Drive**

The ATV in two wheel drive mode. Power is supplied to the rear wheels.

This is mainly use for normal riding.

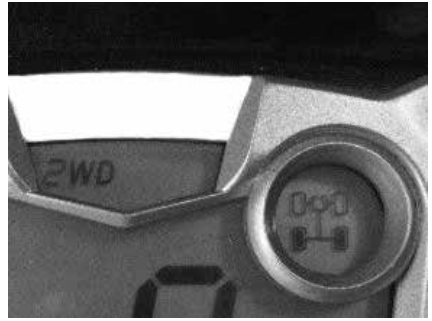

### **4WD: Four Wheel Drive**

Engage the engine power on all four wheels. There is a limited slip gear assembly inside the front differential to engage the right and left front wheels at different speeds. 4WD provides much more traction than 2WD and should be used when riding on wet and slippery surfaces.



### **4WD LOCK:**

Engage the engine power on all four wheels without engaging the limited slip gear assembly. This provides traction to all four wheels evenly and should be used when two or more wheels lose traction.



## **WARNING**

Always ride at a slow speed when the ATV is in differential gear lock and allow extra time and distance for maneuvers.

All wheels turn at the same speed when the differential gear is locked, so it takes more effort to turn the ATV. The effort needed to turn increases with the riding speed. You may lose control and have an accident if you cannot make a sharp enough turn for the speed you are traveling.

## Location of Parts and Controls

Stop the ATV, ensure the 4WD button is pushed in, then rotate the differential gear lock lever to the “LOCK” position. When the differential gear is locked, the differential gear lock indicator “LOCK” will be illuminated on the multi-function display..

To release the differential gear lock, stop the ATV and turn the gear lock lever to the “4WD” position.

**Note: Riding before the differential gear lock is properly engaged will cause the vehicle speed to be limited until engagement is complete.**



### **WARNING**

Rotating the gear lock lever when ATV is moving can be extremely dangerous and you can lose control of the vehicle. The gearbox mechanism can be damaged if the lever is moved while the ATV is in motion.





Always stop the ATV completely before shifting between 2WD, 4WD and LOCK.

# Location of Parts and Controls

## Speedometer



- 1. Fuel Meter bar
- 2. Speedometer
- 3. Function Display
- 4. MODE Button
- 5. 2WD / 4WD Indicator
- 6. LED Indicator Symbols
- 7. SET Button
- 8. EPS Mode

	Main Beam Headlamp - Blue	L/H	Drive Gear - Green
	Engine oil indicator - Red	N	Neutral Gear - Green
	Battery charge indicator	R	Reverse Gear - Green
	Engine coolant temperature - Red	P	Parking Gear
	Engine Check - Yellow		

## Location of Parts and Controls

1. Engine oil indicator (Red): if this light turns on, check the engine oil level, if oil level is good, contact your local ARGO dealer for inspection.



### WARNING

The engine oil warning light will illuminate when the oil level is too low. After adding the correct amount of oil, the warning light will turn off. Never operate the vehicle with the oil warning light illuminated.

Operating the vehicle with the oil warning light illuminated will cause severe engine damage.

2. Temperature indicator (Red): if this light turns on with engine running it implies cooling system problem. Contact with your local ARGO dealer for inspection.
3. Battery charge warning light: if this light turns on while engine running, there may be a malfunction of the charging system. Contact an authorized ARGO dealer for inspection.

**NOTE: When turning on ignition switch, engine oil indicator, temperature indicator, and battery indicator will self-diagnose. If the system does not run the self-diagnostic program, there is a malfunction in the system. Contact an authorized ARGO dealer for inspection.**

4. Engine check light (Yellow): if this light turns on, contact an authorized ARGO dealer for inspection.
5. EPS "FAIL" blinking indicate EPS malfunction and the defect code will show on the bottom line of screen with "c####", please contact an authorized ARGO dealer.

## Functions Display

### RPM: Digital Tachometer

1. RPM is displayed in 2nd row.
2. Digital tachometer displays up to 19,900 RPM.
3. Tachometer signal is picked up from either ECU or Ignition coil.

### MAX RPM: Maximum Tachometer

1. MAX RPM is displayed on 2nd row.
2. Displays highest tachometer reading achieved after last RESET operation.

### SPEED: Speedometer

1. Speedometer display is on 1st row of the screen.
2. Displays speedometer reading up to 187.5 MPH or 300 Km/H.

### MAX SPEED: Maximum Speedometer

1. MAX is displayed on 1st row.
2. Displays highest speed achieved after last RESET operation.

### SPEED AVG: Average Speedometer

1. AVG is displayed on 2nd row.
2. Calculates average speed from last RESET.

## **Location of Parts and Controls**

### **TRIP A & TRIP B: Trip Meter A & B**

1. TRIP function registers cumulative trip distance from last RESET while ATV is being ridden.
2. Display is on 2nd row of screen.

### **ODO: Odometer**

1. ODO registers cumulative distance traveled during operation.
2. ODO data is stored in memory even when power is off.

### **RT: Riding Timer**

1. Calculates total operation time from last RESET.
2. Count automatically begins with vehicle movement.

### **TT: Total Riding Timer**

1. Calculates total operation time from the beginning of ATV use.
2. Count automatically begins with vehicle movement.
3. TT data is stored in memory even when power is off.

### **FUEL METER (only on models with this function)**

1. 7 bar graphic indicator of full fuel status.
2. Last bar flashes to indicate low fuel level.

## **Button Operations**

### **MODE BUTTON**

1. Press the MODE button to move all functions in loop sequence from one function screen to another.

***ODO → RPM → TRIP A → TRIP B → MAX SPEED → SPEED AVG → RT → TT → MAX RPM → TIME → EPS → ODO***

2. Press MODE for 10 seconds to change the display for KMH or MPH.

### **RESET FUNCTION**

1. Press MODE to the desired screen then press MODE and SET button simultaneously for 6 seconds to reset the data from stored values to zero. Each function must be reset individually.
2. ODO, Clock and TT data cannot be reset.

### **TIME FUNCTION**

1. Press MODE button to cycle through to the ODO screen for TYPE I or the TIME screen for TYPE II, then press the MODE and SET button simultaneously for 3 seconds to set up the time.
2. When the digit is blinking, press the SET button to desired digit then press MODE button to move to the next digit.
3. After setting the time, press MODE and SET button simultaneously to save and get back to ODO screen.

## Locations of Parts and Controls

4. During setting, if the digit did not change over 10 seconds, the setting will auto save and go back to time screen.
5. When speed over 6 mph (10 km/h), the setting will save automatically.

### EPS (Electric Power Steering) FUNCTION

The EPS indicator comes on when you press the MODE button and scroll to the EPS function. You can select engage or disengage the EPS function as needed. The indicator remains on when EPS is engaged and the ignition is turned ON, and you can set up the steering torque to Max or Min.

**MIN:** Low steering torque, used for smooth terrain and high speed.

**MAX:** High steering torque, used for rough terrain and low speed.

**FAIL:** EPS failure, blinking indicates EPS malfunction and the defect code will be shown on the bottom line of screen with "c #####".

### Seat

#### To remove the seat:

1. Open the lock by turning the key.
2. Pull up the seat at rear.

#### To install the seat:

Insert the tongue on the front of the seat into seat holders and push down on the seat at the rear. Make sure that the seat is securely fitted.



### Storage Compartments

This ATV equipped with two storage compartments, which are located at the front right and left side. To access the storage compartment, turn knob to access the storage compartment.

When storing any documents in the storage compartments, be sure to wrap them in a protective plastic bag so that they will not get wet. When washing the ATV, be careful not to let any water enter the storage compartments.

A drain plug is fitted at the bottom of the front storage compartment. If any water collects in a storage compartment, remove the drain plug and drain the water. Dry the compartment with a cloth and reinstall the drain plug.



## Locations of Parts and Controls

### Battery

The battery is located under the seat. This model is equipped with a maintenance free battery. There is no need to check the electrolyte or to add distilled water. However, the battery lead connections need to be checked and tightened if necessary following the periodic maintenance table.



### WARNING

Battery electrolyte is poisonous and dangerous as it contains sulfuric acid, which can cause severe burns. Avoid contact with skin, eyes or clothing. Always shield your eyes when working near batteries.

Batteries produce explosive gases. Keep sparks, flame, cigarettes or other sources of ignition away. Ventilate when charging or using in an enclosed space.

**KEEP OUT OF REACH OF CHILDREN**



### CAUTION

When removing the battery, the ignition switch must be in the "OFF" position and the negative battery lead must be disconnected before the positive lead.

### Fuse Box

There are two fuse boxes on this model, one is the main fuse box and the other is the EPS fuse box.

For **EPS** model, the MAXI fuse is located in the EPS fuse box which is under the seat on the right side of the ATV.



## Location of Parts and Controls

### AUXILIARY DC JACK

The auxiliary DC jack is located at the front right side of the ATV. The Auxiliary DC jack can be used for suitable work lights, radios, etc. The auxiliary DC jack should only be used when the engine is running and light switch is set to the "OFF" position. When the auxiliary DC jack is being used the electric current should not exceed 5 A.

1. Set the light switch to the "OFF" position.
2. Turn the accessory "OFF".
3. Start the engine.
4. Open the auxiliary DC jack cap and then insert the accessory power plug into the jack.
5. Turn the accessory "ON".
6. When the auxiliary DC jack is not being used, cover it with the cap.



### CAUTION

- Do not use accessories requiring more than 5 A. This may overload the current and cause the fuse to blow.
- If accessories are used without the engine running or with the headlights turned on, the battery will lose its charge and engine starting may become difficult.
- Do not use an automotive cigarette lighter or other accessories with plug that gets hot because the jack can be damaged.

### Throttle Lever

Throttle lever is operated by the thumb. Pressing the lever opens the throttle. When pressure is released, spring tension automatically closes the throttle. Regulate the speed of the ATV by varying the throttle position.

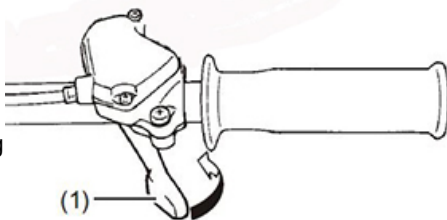

1. Throttle lever



### WARNING

#### POTENTIAL HAZARD

Throttle malfunction.

#### WHAT CAN HAPPEN

The throttle could be hard to operate, making it difficult to speed up or slow down when you need to. This could cause an accident.

#### HOW TO AVOID THE HAZARD

Check the operation before you start the engine. If it does not work smoothly, check for the cause.

Correct the problem before riding the ATV.

Consult an authorized ARGO dealer if you can not locate or solve the issue yourself.



## Location of Parts and Controls

### Speed Limiter

The speed limiter keeps the throttle from fully opening, even when the throttle lever is pushed to the maximum. Screwing IN the adjuster limits the maximum engine power available and decreases the maximum speed of the ATV.

1. Adjuster
2. Locknut
- A. 0.72 in (18 mm)

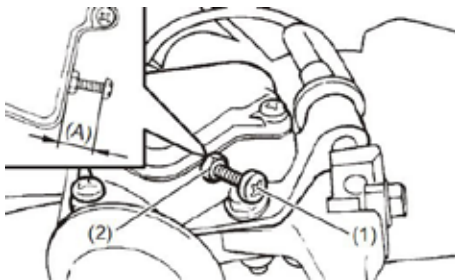

## WARNING

### POTENTIAL HAZARD

Improper adjustment of the speed limiter and throttle.

### WHAT CAN HAPPEN

The throttle cable could be damaged. Improper throttle operation could result causing you to lose control of the ATV and be injured or cause an accident.

### HOW TO AVOID THE HAZARD

Do not turn the speed adjuster out more than 0.72 in. (18 mm). Always make sure the throttle lever free play is adjusted to 0.12-0.2 in. (3-5 mm).

### Air Cleaner

The air cleaner is located under the seat. Follow the periodic maintenance table for proper maintenance.



## WARNING

Always use parts cleaning solvent to clean the sponge material. Never use a low-flash-point solvent or gasoline to clean the sponge material.

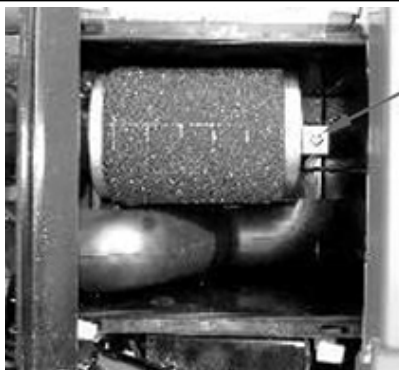
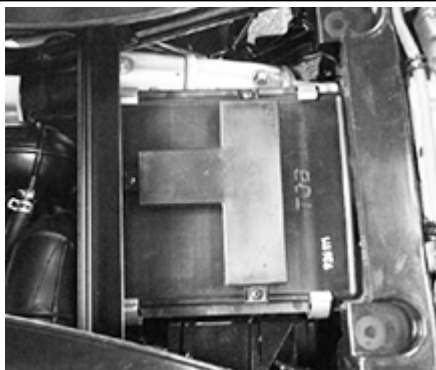

## Location of Parts and Controls

### Tool Kit

A tool kit is provided with your ATV. It is recommended to put the tool kit in the vinyl bag and always carry them in the storage compartment.

1. Air pressure gauge
2. Spark plug wrench
3. 10/14 mm wrench
4. Standard/Phillips screwdriver
5. Screwdriver handle



## NOTES

## SECTION 5

# Getting to Know Your ATV

### Getting To Know Your ATV

This ATV is for recreation use. This section, riding your ATV, provides general ATV riding instructions for recreational riding. The skills and techniques described in this section, however, are appropriate for all types of riding. Riding your ATV requires special skills acquired through practice over a period of time. Take the time to learn the basic techniques well before attempting more difficult maneuvers.

Riding your new ATV can be a very enjoyable activity, providing you with hours of pleasure. But it is essential to familiarize yourself with the operation of the ATV to achieve the skill necessary to enjoy riding safely. Before you begin to ride, be sure you have read this Owner's Manual completely and understand the operation of the controls. Pay particular attention to the caution and warning labels on your ATV.

### Weight Limits

There are limits to how much weight can be carried on your ATV. See Weight Limits section in the Specifications section. Modifying your ATV, using non-standard equipment or riding on terrain that is not flat and smooth could further reduce these limits.

Never exceed the stated load capacities for this vehicle. Cargo should be properly distributed and securely attached. Reduce speed when carrying cargo or pulling a trailer and allow greater distance for braking. Modifying your ATV, using non-standard equipment or riding on terrain that is not flat and smooth could further reduce these limits.

### Before Riding

You need to prepare before riding. This includes getting proper instruction, making sure your ATV is in good operating condition, and learning some basic safe-riding rules.

### Rider Preparation - Age Recommendation

The minimum age for this ATV model is 16. For safety, never let anyone under 16 years old operate this vehicle.

### Pre-operation Checks

Always inspect your ATV each time you use it to make sure the ATV is in safe operating condition. Perform the pre-operation checks listed in this manual. Always follow the inspection and maintenance procedures and schedules described in the Owner's Manual.

### Safe Riding Rules

Please note that the safe Riding Rules apply to all ATV riders. Even if you are an experienced rider, or after you become one continue to follow these guidelines for your own safety and enjoyment.

### Protective Apparel

Always wear an approved motorcycle helmet when riding your ATV. You should also always wear goggles or a face shield, gloves, boots, a long-sleeved shirt or jacket, and long pants.

## Getting To Know Your ATV

### Accessories

Genuine ARGO accessories have been specifically designed for and tested on this vehicle. Because ARGO cannot test all other accessories, you are personally responsible for properly selecting, installing, and using non- ARGO accessories.

1. Carefully inspect the accessory to make sure it does not block any lights, reduce ground clearance, or limit suspension travel, steering travel, or other controls.
2. Make sure the accessory does not interfere with your ability to shift body position on the seat or operate hand and foot controls.
3. Do not add electrical equipment that will exceed the vehicle's electrical system capacity. A blown fuse could cause a loss of lights or engine power.

### No Modifications

Modifying this ATV or removing original equipment may render the vehicle unsafe or illegal. Spark arresters and mufflers are required in most areas. Don't modify your exhaust system or emission control system components. Remember, excessive noise bothers everyone and creates a bad image for off-road vehicles.

### For Off-Road Use Only

This ATV is designed and manufactured for off-road use only.

Do not ride in areas posted "no-trespassing". Do not ride on private property without getting permission.

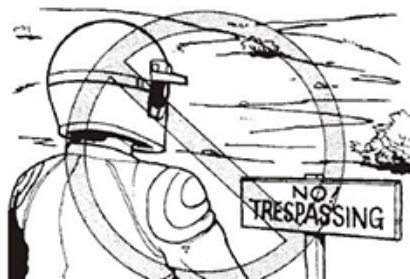

### Exhaust System



#### **WARNING**

**Dry grass or brush or other combustible material accumulated around the engine area could create a thermal event. Do not operate, idle or park the ATV in dry grass or other dry ground cover. Keep the engine area free of dry grass, brush or other combustible material.**

**Someone touching the exhaust system during or after operation could be severely burned. Do not touch the hot exhaust system; do not park the ATV in a place where others might be likely to touch the exhaust pipe.**

The muffler and other engine parts become extremely hot during operation and remain hot after the engine has stopped. To reduce the risk of a thermal event during operation or after leaving the ATV, do not let brush, grass or other materials collect under the vehicle, near the muffler or exhaust pipe or next to other hot parts. Check under the vehicle after operating in areas where combustible material may have collected. Do not idle or park the vehicle in long dry grass or other dry ground cover.

To prevent burns, avoid touching the exhaust system. Park the ATV in a place where pedestrians or children are not likely to touch it.

## Getting To Know Your ATV

### Braking

Practice starting and stopping at slow speeds. Gradually work up to faster starts and stops.

1. Steer straight ahead. Close the throttle completely, remove your thumb from the throttle lever.
2. Gently apply the brakes: compress left hand lever and depress foot pedal.

Gradually increase the lever pressure as you feel the brakes slowing your speed. The pressure used depends on your speed and the condition of the terrain you are riding. Slick, slippery or muddy ground requires gentler braking.

Pulling the brake lever too hard may cause the front and/or rear wheels to skid or slide out of control. If this happens, release all pressure on the lever immediately. Steer straight ahead to regain control. Then gently reapply the brakes.

Independent use of only the front or rear brakes reduces stopping performance. Extreme braking may cause the wheels to lock, reducing control of the ATV.

When possible, reduce speed or brake before entering a turn. Closing the throttle or braking in mid-turn may cause wheel slippage which will reduce control of your ATV.

### Sliding or Skidding

Care should be used when riding on loose or slippery surfaces since the ATV may slide. If unexpected and uncorrected, sliding could lead to an accident.

To reduce the tendency for the front wheels to slide in loose or slippery conditions, positioning your weight over the front wheels will sometimes help.

If the rear wheels of your ATV start to slide sideways, control can usually be regained (if there is room to do so) by steering in the direction of the slide. Applying the brakes or accelerating is not recommended until you have corrected the slide.

With practice, over a period of time, skill at controlled sliding can be developed. The terrain should be chosen carefully before attempting such maneuvers, since both stability and control are reduced. Bear in mind that sliding maneuvers should always be avoided on extremely slippery surfaces such as ice, since all control may be lost.



## Getting To Know Your ATV

### Turning Your ATV

To achieve maximum traction while riding off-road, the two rear wheels are mounted solidly on one axle and turn together at the same speed. Therefore, unless the wheel on the inside of the turn is allowed to slip or lose some traction, the ATV will resist turning. A special turning technique must be used to allow the ATV to make turns quickly and easily. It is essential that this skill be learned first at low speed.

Lean towards  
inside of turn.

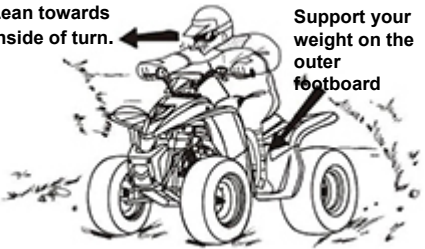

Support your  
weight on the  
outer  
footboard

As you approach a curve, slow down and begin to turn the handlebars in the desired direction. As you do so, put your weight on the footboard to the outside of the turn (opposite your desired direction) and lean your upper body into the turn. Use the throttle to maintain an even speed through the turn. This maneuver will let the wheel on the inside of the turn slip slightly, allowing the ATV to make the turn properly.

This procedure should be practiced at slow speed many times in a large off-road area with no obstacles. If an incorrect technique is used, your ATV may continue to go straight. If the ATV doesn't turn, come to a stop and then practice the procedure again. If the riding surface is slippery or loose, it may help to position more of your weight over the front wheels by moving forward on the seat.

Once you have learned this technique you should be able to perform it at higher speeds or in tighter curves.

Improper riding procedures such as abrupt throttle changes, or too much speed for the sharpness of the turn may cause the ATV to tip. It may also be necessary to the outside of the turn to avoid tipping over.

Remember: Avoid higher speeds until you are thoroughly familiar with the operation of your ATV.

### Climbing Uphill

Use proper riding techniques to avoid vehicle overturns on hills. Be sure that you can maneuver your ATV well on flat ground before attempting any incline and then practice riding first on gentle slopes. Try more difficult climbs only after you have developed your skill. In all cases avoid inclines with slippery or loose surfaces, or obstacles that might cause you to lose control.

It is important when climbing a hill to make sure that your weight is transferred forward on the ATV. This can be accomplished by leaning forward and, on steeper inclines, standing on the footboards and leaning forward over the handlebars.

If you are climbing a hill and you find that you have not properly judged your ability to make it to the top, you should turn the ATV around while you still have forward motion (provided you have the room to do so) and go down the hill.

If your ATV has stalled or stopped and you believe you can continue up the hill, restart carefully to make sure you do not lift the front wheels which could cause you to lose control. If you are unable to continue up the hill, dismount the ATV on the uphill side. Physically turn the ATV around and then descend the hill.

## Getting To Know Your ATV

### Climbing Uphill

If you start to roll backwards, DO NOT use the rear brake to stop. The ATV could easily tip over backwards. Instead, dismount the ATV immediately on the uphill side.

If the hill is not too steep and you have good footing, you may be able to walk the ATV back down the hill. Make sure your intended path is clear in case you lose control of the ATV. If you decide you can walk the ATV safely:

1. Stand with your body facing downhill, beside the vehicle so you can reach the rear brake lever with your left hand.
2. Be sure your legs are clear of the wheels.
3. Check your footing.
4. Then slowly and carefully back the ATV down the hill using the front brake lever to control speed.
5. If you lose control of the ATV, for your safety, get away from the vehicle.



If the hill is too steep or too slippery, or if you have any doubt whether you can safely walk the ATV back down the hill, leave the vehicle where it is and get help. If possible, block the wheels so the vehicle won't roll backwards.



### Riding Downhill

When riding your ATV downhill, shift your weight as far to the rear and uphill side of the ATV as possible. Move back on the seat and sit with your arms straight. Improper braking may cause a loss of traction.

Use caution while descending a hill with loose or slippery surfaces. Braking ability and traction may be adversely affected by these surfaces.

Improper braking may also cause a loss of traction. Whenever possible, ride your ATV straight downhill. Avoid sharp angles which could allow the ATV to tip or roll over. Carefully choose your path and ride no faster than you will be able to react to obstacles which may appear.

### Riding Over Rough Terrain

Riding over rough terrain should be done with caution. Look out for obstacles which could cause damage to the ATV or could lead to an accident. Be sure to keep your feet firmly mounted on the footboards at all time. Avoid jumping the ATV as loss of control and damage to the ATV may result.



## Getting To Know Your ATV

### Crossing A Slope

Traversing a sloping surface on your ATV requires you to properly position your weight to maintain proper balance. Be sure that you have learned the basic riding skills on flat ground before attempting to cross a sloping surface. Avoid slopes with slippery surfaces or rough terrain that may upset your balance.

As you travel across a slope, lean your body in the uphill direction. It may be necessary to correct the steering when riding on loose surfaces by pointing the front wheels slightly uphill. When riding on slopes be sure not to make sharp turns either up or down hill.

If your ATV does begin to tip over, gradually steer in the downhill direction if there are no obstacles in your path. As you regain proper balance, gradually steer again in the direction you wish to travel.

### Crossing Through Shallow Water

The ATV can be used to cross slow moving, shallow water up to the bottom of the floorboards. Before entering the water, choose your path carefully. Enter where there is no sharp drop off, and avoid rocks or other obstacles which may be slippery or upset the ATV. Drive slowly and carefully.



Test your brakes after leaving the water. Do not continue to ride your ATV without verifying that you have regained proper braking ability.

### Parking

Always choose a level place to park. After bringing your ATV to a stop, hold the brakes while you shift into Park. Once gear shift is in the Park position, turn the ignition switch OFF.



### CAUTION

Always leave the ignition switch in the “OFF” position when the engine is not running. Leaving the ignition switch in the “ON” position when the engine is not running may cause the battery to discharge.

## Getting To Know Your ATV

### **WHAT TO DO IF**

This section is designed to be a reference guide only. Be sure to read each section on riding techniques completely.

### **WHAT TO DO....**

#### ***If your ATV doesn't turn when you want it to:***

Bring the ATV to a stop and practice the turning maneuvers again. Be sure you are putting your weight on the footboard to the outside of the turn. Position your weight over the front wheels for better control.

#### ***If your ATV begins to tip while turning:***

Lean more into the turn to regain balance. If necessary, gradually let off the throttle and /or steer to the outside of the turn.

#### ***If your ATV starts to slide sideways:***

Steer in the direction of the slide if you have the room.

Applying the brakes or accelerating is not recommended until you have corrected the slide.

#### ***If your ATV can't make it up a hill you are trying to climb:***

Turn the ATV around if you still have forward speed. If not, stop, dismount on the uphill side of the ATV and physically turn the ATV around. If the ATV starts to slip backwards DO NOT USE THE REAR BRAKE - the ATV may tip over on top of you. Dismount the ATV on the uphill side.

#### ***If your ATV is traversing a sloping surface:***

Be sure to ride with your weight positioned towards the uphill side of the ATV to maintain proper balance. If the ATV starts to tip, steer down the hill (if there are no obstacles in your way) to regain balance. If you discover that the ATV is going to tip over, dismount on the uphill side.

#### ***If your ATV encounters shallow water:***

Ride slowly and carefully through slow moving water, watching for obstacles. Be sure to let water drain from the ATV and CHECK YOUR BRAKES FOR PROPER OPERATION when you come out of the water. Do not continue to ride your ATV until you have regained adequate braking ability.

## NOTES

## SECTION 6

### Before You Ride

#### Engine Break-In

There is never a more important period in the life of your ATV than the period between 0 and 20 hours.

For this reason, we ask that you carefully read the following material. Because the engine is brand new, you must not put an excessive load on it for the first 20 hours, the various parts in the engine wear and polish themselves to the correct operating clearances.

During this period, prolonged full throttle operation or any condition which might result in excessive engine heating must be avoided. However, momentary (2~3 seconds maximum) full throttle operation under load does not harm the engine. Each full throttle acceleration sequence should be followed with a substantial rest period for the engine by cruising at lower rpm so the engine can rid itself of the temporary build up of heat.

If any abnormality is noticed during this period, consult an authorized ARGO dealer.

1. 0 - 10 hours (0-100 miles) (0-160 km):

Avoid continuous operation above half throttle. Allow a cooling off period of five to ten minutes after every hour of operation. Vary the speed of the machine from time to time. Do not operate it at full throttle position.

2. 10 - 20 hours (100-200 miles) (160-320 km):

Avoid prolonged operation above 3/4 throttle. Rev the machine freely through the gears but do not use full throttle at any time.

3. After break-in:

Avoid prolonged full throttle operation. Vary speeds occasionally.

#### Pre-Operation Checks

Inspect your vehicle each time you use it to make sure the vehicle is in safe operating condition.

Always follow the inspection and maintenance procedures and schedules described in your Owner's Manual.



#### **WARNING**

Failure to inspect or maintain the vehicle properly increase the possibility of accident or equipment damage. Do not operate the vehicle if you find any problem. If a problem cannot be corrected by the procedures provided in this manual, have the vehicle inspected by the dealer.

## Operation - Before You Ride

Before operating this ATV, check the following points:

ITEM	ROUTINE
Fuel	<ul style="list-style-type: none"><li>• Check fuel level in fuel tank and add recommended fuel if necessary.</li><li>• Check fuel line for leakage. Correct if necessary.</li></ul>
Engine Oil	<ul style="list-style-type: none"><li>• Check oil level in engine and add recommended oil to specified level if necessary.</li><li>• Check ATV for oil leakage. Correct if necessary.</li></ul>
Front Differential / Rear Gearcase Oil	<ul style="list-style-type: none"><li>• Check ATV for oil leakage. Correct if necessary.</li></ul>
Coolant	<ul style="list-style-type: none"><li>• Check coolant level in reservoir and add recommended coolant to specified level if necessary.</li><li>• Check cooling system for leakage. Correct if necessary.</li></ul>
Front Brake	<ul style="list-style-type: none"><li>• Check operation, if soft or spongy, have the dealer bleed the hydraulic system.</li><li>• Check brake pads for wear and replace if necessary.</li><li>• Check brake fluid level in reservoir and add recommended brake fluid to specified level if necessary.</li><li>• Check hydraulic system for leakage. Correct if necessary.</li></ul>
Rear Brake	<ul style="list-style-type: none"><li>• Check operation and correct if necessary.</li><li>• Lubricate cables if necessary.</li><li>• Check lever free play and adjust if necessary.</li></ul>
Throttle Lever	<ul style="list-style-type: none"><li>• Ensure smooth operation. Lubricate cable and lever housing if necessary.</li><li>• Check lever free play and adjust if necessary.</li></ul>
Control Cables	<ul style="list-style-type: none"><li>• Ensure smooth operation. Lubricate if necessary.</li></ul>
Wheels and Tires	<ul style="list-style-type: none"><li>• Check wheel condition and replace if damaged.</li><li>• Check tire condition and tread depth. Replace if necessary.</li><li>• Check air pressure. Correct if necessary.</li></ul>
Brake Pedal	<ul style="list-style-type: none"><li>• Ensure smooth operation. Lubricate pedal pivoting point if necessary.</li></ul>
Brake Levers	<ul style="list-style-type: none"><li>• Ensure smooth operation. Lubricate lever pivoting point if necessary.</li></ul>
Axle Boots	<ul style="list-style-type: none"><li>• Check for cracks or damage and replace if necessary.</li></ul>
Chassis Fasteners	<ul style="list-style-type: none"><li>• Ensure all nuts, bolts and screws are properly secured.</li></ul>
Instruments, Lights and Switches	<ul style="list-style-type: none"><li>• Check operation and correct if necessary.</li></ul>

## Operation - Before You Ride

### Front and Rear Brakes

#### 1. Brake operation

Test the brakes at slow speed after starting out to make sure they are working properly. If the brakes do not provide proper braking performance, inspect the brakes for wear.



### **WARNING**

#### **POTENTIAL HAZARD**

Riding with improperly operating brakes.

#### **WHAT CAN HAPPEN**

You could lose braking ability, which could lead to an accident.

#### **HOW TO AVOID THE HAZARD**

Always check the brakes at the start of every ride. Do not ride the ATV if you find any problem with the brakes. If a problem cannot be corrected by the adjustment procedures provided in this manual, have the ATV inspected by an authorized ARGO dealer.

### Fuel

Fill the fuel tank when necessary and make sure there is sufficient gasoline in the tank.

Check for leaks.

Monitor during refill to prevent over filling.

#### Recommended Fuel

Unleaded - 87 or higher

#### Fuel Tank Capacity:

Total - 4.2 gal (16 L)

Your ARGO engine has been designed to use regular unleaded gasoline with a pump octane number of 87 or higher. If knocking or pinging occurs, use a different brand of gasoline or premium unleaded fuel. Unleaded fuel will give you longer spark plug life and reduced maintenance cost.

Use unleaded fuel only because it produces fewer engine and spark plug deposits and extends the life of the exhaust system. Never use stale or contaminated gasoline or an oil/gasoline mixture. Avoid getting dirt, dust or water in the fuel tank.



### **WARNING**

#### **POTENTIAL HAZARD**

Improper care when refueling.

#### **WHAT CAN HAPPEN**

Fuel can spill, which can cause a thermal event and severe injury may result.

#### **HOW TO AVOID THE HAZARD**

Do not overfill the fuel tank. Be careful not to spill fuel, especially on the engine or exhaust pipe. Wipe up any spilled fuel immediately. Be sure the fuel tank cap is closed securely. Do not refuel immediately after the engine has been running and is still very hot.

## Operation - Before You Ride

### Engine Oil

Make engine oil level should be checked before each ride. In addition, the oil must be changed at the intervals specified in the periodic maintenance table. Ensure the engine oil is at the specified level. Add oil as necessary. Check for any leaks.

Recommended engine oil classification:  
Engine - SAE 10W-40



### CAUTION

Be sure to use motor oils that do not contain anti-friction modifiers. Passenger car motor oils (often labeled "Energy Conserving") contain anti-friction additives which will cause starter clutch slipping, resulting in reduced component life and poor engine performance.

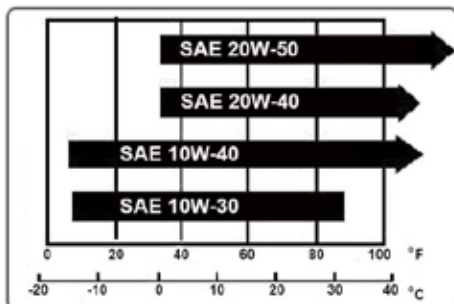

### To check the engine oil level:

**NOTE:** Check the engine oil level on a cold engine.

1. Place the ATV on a level surface.
2. Remove the side access cover.

**NOTE:** If the engine was started before checking the oil level, allow the engine to warm up to operating temperature, then wait at least 10 minutes to allow the oil to settle for an accurate oil reading.

3. Remove the engine oil filler cap and wipe oil dipstick with a clean rag.
4. Insert the dipstick into the filler hole ensuring it is threaded in clockwise and tightened. Remove it again to check the oil level.

**NOTE:** The engine oil should be between the minimum and the maximum level mark.

5. If the engine oil is not between the minimum and the maximum level mark, add sufficient oil of the recommended type to raise it to the correct level.

**NOTE:** Be sure the engine oil is at the correct level, otherwise engine damage may result.

6. Insert the dipstick into the oil filler hole and tighten the cap.
7. Install the side cover.

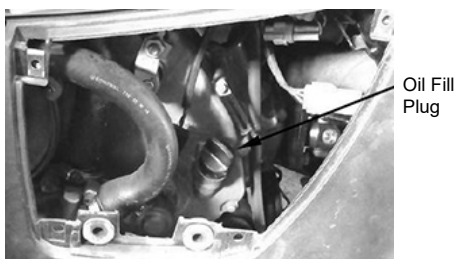

## Operation - Before You Ride

### Front Differential Gear Oil

The differential gear case level should be checked for oil leakage before each ride. If any leakage is present, take the ATV to an authorized ARGO dealer for service. In addition, the differential gear oil level must be checked and the oil changed following the interval schedule in the periodic maintenance and lubrication chart.

**Recommended Oil:** 85W-90

#### To check the front differential gear oil level:

1. Place the ATV on a level surface.
2. Remove the differential gear oil filler bolt and its gasket. Check the oil level in the differential gear case. The oil level should be at the brim of the filler hole.

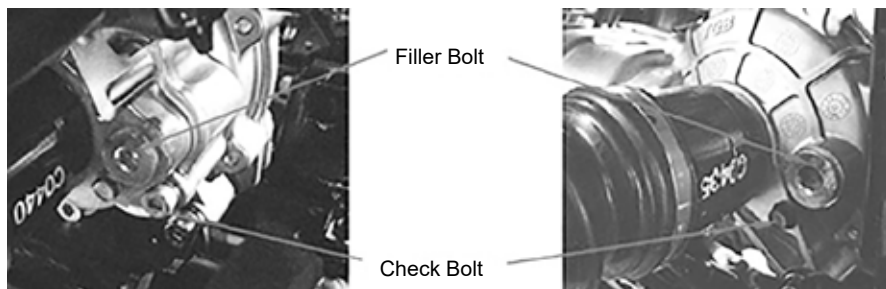

3. If the oil is below the brim of the filler hole, add sufficient oil (85W90) to raise it to the correct level.
4. Check the gasket for damage and replace it if necessary.
5. Install the oil filler bolt and its gasket and then tighten the bolt to:  
Differential gear oil filler bolt - 24 ft lb (32.36 Nm)  
Differential gear oil check bolt - 5.75 ft lb (7.8 Nm)

### Rear Gearcase Oil

The rear gearcase level should be checked for oil leakage before each ride. If any leakage is present, take the ATV to an authorized ARGO dealer for service. In addition, the rear gearcase oil level must be checked and the oil changed following the interval schedule in the periodic maintenance and lubrication chart.

#### To check the rear gearcase oil level:

1. Place the ATV on a level surface.
2. Remove the rear gearcase oil filler bolt and its gasket. Check the oil level in the rear gearcase. The oil level should be at the bottom of the filler hole.



**Recommended Oil:** 85W-90



## Operation - Before You Ride

3. If the oil is below the bottom of the filler hole, add sufficient oil (85W90) to raise it to the correct level.
4. Check the gasket for damage and replace it if necessary.
5. Install the oil filler bolt and its gasket and then tighten the bolt to:  
Rear gearcase oil filler bolt - 24 ft lb (32.36 Nm)  
Rear gearcase oil check bolt - 5.75 ft lb (7.8 Nm)

## Coolant

The coolant level should be checked before each ride. In addition, the coolant must be changed at the intervals specified in the periodic maintenance and lubrication chart.

### To check the coolant level:

1. Place the ATV on a level surface.

**NOTE: The coolant level must be checked on a cold engine since the level varies with engine temperature.**

2. Check the coolant level in the coolant reservoir.

**NOTE: The coolant should be between the minimum and maximum level marks.**

Coolant reservoir capacity (up to the maximum level mark):  
1.25 qt (1.2 L)

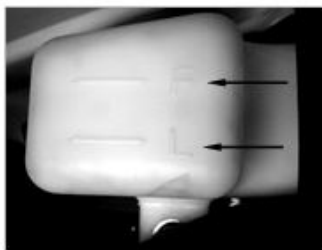

If the coolant is at or below the minimum level mark, remove the coolant reservoir cap, add coolant or distilled water to the maximum level mark and install the reservoir cap.



## CAUTION

If coolant is not available, use distilled water or soft tap water instead. Do not use hard water since it is harmful to the engine. If water has been used instead of coolant, replace it with coolant as soon as possible; otherwise the cooling system will not be protected against frost and corrosion. If water has been added to the coolant, have an authorized dealer check the antifreeze content of the coolant as soon as possible, otherwise the effectiveness of the coolant will be reduced.

## Operation - Before You Ride

### Tires

Check tire pressure regularly to make sure they are at the recommended specifications. Check for wear and damage.

1. The tires listed have been approved by ARGO for this model. Other tire combinations are not recommended. This ATV is equipped with tubeless tires with valves.

Use the low-pressure tire gauge to check and adjust tire pressure when the tires are cold. Tire pressures must be equal on both sides.

**NOTE: The low-pressure tire gauge is included as standard equipment. Make two measurements of the tire pressure and use the second reading. Dust or dirt in the gauge could cause the first reading to be incorrect.**

1. Low-pressure tire gauge



## WARNING

### POTENTIAL HAZARD

Operating this ATV with improper tires, or with improper or uneven tire pressure.

### WHAT CAN HAPPEN

Use of improper tires on this ATV, or operation of this ATV with improper or uneven tire pressure, may cause loss of control, increasing the risk of an accident.

### HOW TO AVOID THE HAZARD

Follow the recommended tire pressures above.

### Tire Wear Limit

When the tire groove decreases to 0.12 in (3 mm) due to wear, replace the tire.

- A. 0.12 in (3 mm)

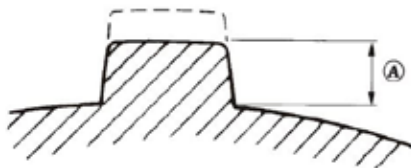

## Operation - Before You Ride

### Throttle Lever

Check to see that the throttle lever operates correctly. Throttle must open smoothly and spring back to the idle position when released. Adjust as necessary for proper operation.

### Lights

Check the headlight and taillight to ensure they are in proper operating condition. Repair as necessary for proper operation.

### Switches

Check the operation of the headlight switch, engine stop switch and any other switches. Repair as necessary for proper operation.

### Fittings and Fasteners

Always check chassis fittings and fasteners to ensure they are tight and secure. Take the ATV to an authorized ARGO dealer or refer to the Service Manual for correct torque specifications.



## WARNING

### POTENTIAL HAZARD

Operating this ATV without being familiar with all controls and functions.

### WHAT CAN HAPPEN

Loss of control, increasing the risk of an accident or injury.

### HOW TO AVOID THE HAZARD

Read the Owner's Manual carefully. If there is a control or function you do not understand, contact an authorized ARGO dealer.

## SECTION 7

### Operation

Always wear the following to reduce risk of injury in an accident:

- Approved motorcycle helmet that fits properly.
- Eye protection (goggles, helmet face shield or protective eyewear)
- Over the ankle boots, gloves, long sleeved shirt or jacket and long pants.

An approved helmet and other personal protective equipment can reduce the severity of injuries in an accident.



#### **WARNING**

**Operating without an approved motorcycle helmet increases your chances of a severe head injury or death in the event of an accident.**

Wear eye protection when operating your ATV to reduce the risk of a serious accident or injury. Eye protection such as a face shield or goggles may reduce the risk of foreign material getting in your eyes and help prevent loss of vision.



#### **WARNING**

**Operating without eye protection can result in an accident and increases your chances of a severe injury in the event of an accident.**

#### **Mounting the ATV**

1. From the left side, grasp the left-side handlebar, apply the left-side hand brake, and put your left foot on the footrest.
2. Grasp the right-side handlebar.
3. Swing your right leg over the seat and position your right foot on the right-side footrest.
4. Position yourself on the seat.
5. Always keep your feet positioned in the footrests and hands on the handlebars.



#### **CAUTION**

**See the “Engine Break-In” section prior to operating engine for the first time.**



#### **WARNING**

##### **POTENTIAL HAZARD**

Freezing control cables in cold weather.

##### **WHAT CAN HAPPEN**

Loss of control, increasing the risk of an accident or injury.

##### **HOW TO AVOID THE HAZARD**

When riding in cold weather, always make sure all controls and cables function properly before you begin riding.

## Operation

### Starting the Engine

Always start the engine with the ATV on a flat, level surface. Always start your ATV outside as it produces Carbon Monoxide poisoning which will cause harm. Follow these steps to start your ATV:

1. Turn the engine stop switch to "RUN" position.
2. Rotate the ignition switch key to the "ON" position.
3. Ensure ATV is in the "P" (Park) position.
4. Depress the starter button.
5. Allow the engine to properly warm up. Do not depress the throttle lever until the engine has reached operating temperature.



### CAUTION

Do not run the starter motor for more than 8 (eight) seconds per starting attempt as the starter motor may overheat causing severe damage. Allow 15 (fifteen) seconds between starting attempts to allow the starter motor to cool.

**NOTE:** If the starter button is pushed with the ignition switch in the ON position and the engine stop switch in the OFF position, the starter motor will be activated but the engine will not start. To start the engine, be sure the engine stop switch is in the RUN position.

6. Allow the engine to properly warm up. If the engine has not reached proper operating temperature, the spark plug may not have reached a high enough temperature to burn off the excess fuel in the combustion chamber.



### CAUTION

If unburned fuel remains in the combustion chamber due to lack of run time, spark plug fouling may occur during the next starting attempt.

### Warming Up Engine

To get maximum engine life, always warm up the engine. Never accelerate hard with a cold engine! To see whether or not the engine is warm, check if it responds to the throttle normally.



### CAUTION

- Do not operate the throttle (open and close rapidly) as the ATV will move forward suddenly, causing possible loss of control.
- Do not leave the ATV unattended while the engine is warming up.

### Braking / Stopping

Always allow plenty of room and time to come to a easy, smooth stop. To come to a complete stop, you must:

1. To apply both the front and rear brakes, compress left brake lever located on the handlebars and depress the foot brake.
2. If the wheels lock or skid, release the brake lever and apply again.
3. Never hold or depress the brake and accelerate at the same time. This will cause the brake system to overheat.

## Operation

### Parking

Parking requires following the previous rules of braking; then:

1. When the ATV comes to a complete stop, shift ATV into the Park “P” position.
2. Stop the engine using the engine stop switch located on the handlebar.
3. Turn the ignition switch to the “OFF” position.



### CAUTION

Operating the shift lever when the ATV is moving can be hazardous. This is strictly prohibited. Always wait until the ATV is completely stopped. Do not operate the ATV at high speeds in reverse under any circumstances.



### CAUTION

Always leave the ignition switch in the “OFF” position when the engine is not running. Leaving the ignition switch in the “ON” position when the engine is not running may cause the battery to discharge.

### PARKING ON A SLOPE



### WARNING

Avoid parking on hills or other inclines. Parking on a hill or other incline could cause the ATV to roll out of control, increasing the chance of an accident. If you must park on an incline, place the ATV transversely across the incline, stop the engine, pull the parking brake lever to the parking position, and then block the front and rear wheels with rocks or other objects.

Do not park the ATV at all on hills that are so steep you could not walk up them easily.

1. Bring the ATV to a stop by applying the brakes.
2. Ensure the rear differential is locked before switching off the engine.
3. Stop the engine.
4. Pull the hand brake and push the clip to stopper on the left.

### TURNING YOUR ATV



### WARNING

Always follow proper procedures for turning as described in this Owner’s Manual. Practice turning at low speeds before attempting to turn at faster speeds. Do not turn at speeds too fast for your skills or the conditions. ATV could go out of control causing a collision or overturn.



## Operation

To achieve maximum traction while riding off-road, the two rear wheels turn together at the same speed. Therefore, unless the wheel on the inside of the turn is allowed to slip or lose some traction, the ATV will resist turning. A special turning technique must be used to allow the ATV to make turns quickly and easily. It is essential that this skill be learned first at low speed.

As you approach a curve, slow down and begin to turn the handlebars in the desired direction. As you do so, put your weight on the footboard to the outside of the turn (opposite your desired direction) and lean your upper body into the turn. Use the throttle to maintain an even speed through the turn. This maneuver will let the wheel on the inside of the turn slip slightly allowing the ATV to make the turn properly. This procedure should be practiced at slow speed many times in a large off-road area with no obstacles. If an incorrect technique is used, your ATV may continue to go straight. If the ATV doesn't turn, come to a stop and then practice the procedure again. If the riding surface is slippery or loose, it may help to position more of your weight over the front wheels by moving forward on the seat.

Once you have learned this technique, you should be able to perform it at higher speeds or in tighter curves.

Improper riding procedures such as abrupt throttle changes, excessive braking, incorrect body movement or too much speed for the sharpness of the turn may cause the ATV to tip. If the ATV begins to tip over to the outside while negotiating a turn, lean more to the inside. It may also be necessary to gradually let off on the throttle and steer to the outside of the turn to avoid tipping over.

Remember: Avoid higher speeds until you are thoroughly familiar with the operation of your ATV.

## CLIMBING UPHILL



### WARNING

Climbing hills improperly can cause overturns or loss of control. Use proper riding techniques described in this Owner's Manual.



Do not attempt to climb hills until you have mastered basic maneuvers on flat ground. Always check the terrain carefully before attempting any hill. In all cases avoid inclines with slippery or loose surfaces or obstacles that might cause you to lose control.

To climb a hill, you need traction, momentum and steady throttle.

Travel fast enough to maintain momentum but not so fast that you cannot react to changes in the terrain as you climb.

It is important when climbing a hill to make sure that your weight is transferred forward on the ATV. This can be accomplished by leaning forward and on steeper inclines, standing on the footboards and leaning forward over the handlebars. Whenever possible, ride straight up hills.

## Operation

Slow down when you reach the crest of the hill if you cannot see clearly what is on the other side there could be another person, an obstacle or a sharp drop off. Use common sense and remember that some hills are too steep for you to climb or descend.

If you are climbing a hill and you find that you have not properly judged your ability to make it to the top, you should turn the ATV around while you still have forward motion and go down the hill.

If your ATV has stalled or stopped and you believe you can continue up the hill, restart carefully to make sure you do not lift the front wheels which could cause you to lose control. If you are unable to continue up the hill, dismount the ATV on the uphill side. Physically turn the ATV around and then descend the hill.

If you start to roll backwards, DO NOT apply either brake abruptly. Avoid sudden application of either the front or rear brake as the wheels on the uphill side could come off the ground. The ATV could easily tip over backwards. Apply both the front and rear brakes gradually. When fully stopped, apply the brake lever lock and dismount the ATV immediately on the uphill side or to a side if pointed straight uphill. Turn the ATV around and remount, following the procedure described in the Owner's Manual.



### WARNING

Stalling, rolling backwards or improperly dismounting while climbing a hill could result in ATV overturning. If you cannot control the ATV, dismount immediately on the uphill side.

## RIDING DOWN HILL



### WARNING

Going down a hill improperly could cause overturns or loss of control. Always follow proper procedures for going down hills as described in this Owner's Manual.

When riding your ATV downhill, shift your weight as far to the rear and uphill side of the ATV as possible. Move back on the seat and sit with your arms straight. Engine compression will do most of the braking for you.

Use caution while descending a hill with loose or slippery surfaces. Braking ability and traction may be adversely affected by these surfaces. Improper braking may also cause a loss of traction.

When descending hills, gradually apply both front and rear brakes as necessary.

Avoid sudden application of either the front or rear brake because the wheels on the uphill side could come off the ground.

Whenever possible, ride your ATV straight downhill. Avoid sharp angles, which could allow the ATV to tip or roll over. Carefully choose your path and ride no faster than you will be able to react to obstacles, which may appear.





## Operation

### CROSSING A SLOPE



#### WARNING

Improperly crossing hills or turning on hills could cause loss of control or cause the ATV to overturn.

Traversing a sloping surface on your ATV requires you to properly position your weight to maintain proper balance. Be sure that you have learned the basic riding skills on flat ground before attempting to cross a sloping surface. Avoid slopes with slippery surfaces or rough terrain that may upset your balance.

As you travel across a slope, lean your body in the uphill direction. It may be necessary to correct the steering when riding on loose surfaces by pointing the front wheels slightly uphill. When riding on slopes, be sure not to make sharp turns either up or down hill.

If your ATV does begin to tip over, gradually steer in the downhill direction if there are no obstacles in your path. As you regain proper balance, gradually steer again in the direction you wish to travel.



### CROSSING THROUGH SHALLOW WATER



#### WARNING

Operating this vehicle through deep or fast flowing water can lead to loss of control or an overturn. To reduce your risk of drowning or other injuries, use care when crossing through water. Never operate this ATV water deeper than the depth specified in your Owner's Manual, as tires may float, increasing the risk of an overturn.

The ATV can be used to cross slow moving, shallow water up to the bottom of the floorboards. Before entering the water, choose your path carefully. Enter where there is no sharp drop off, and avoid rocks or other obstacles, which may be slippery or upset the ATV. Drive slowly and carefully.

Test your brakes after leaving the water. If necessary, apply them several times to let the friction dry out the linings. Do not continue to ride your ATV without verifying that you have regained proper braking ability.



#### WARNING

Wet brakes may have reduced stopping ability, which could cause loss of control.

After riding your ATV in water, be sure to drain the trapped water by removing the check hose at the bottom of the air filter case to drain any water that may have accumulated.



#### CAUTION

Un-drained water can cause damage or improper operation.

## Operation

### RIDING OVER ROUGH TERRAIN



#### WARNING

Riding improperly over obstacles could cause loss of control or a collision. Before operating in a new area, check for obstacles. Never attempt to ride over large obstacles, such as large rocks or fallen trees. When you go over obstacles, always follow proper procedures as described in the Owner's Manual.

Riding over rough terrain should be done with caution. Look out for obstacles, which could cause damage to the ATV or could lead to an upset or accident. Be sure to keep your feet firmly mounted on the footboards at all times. Avoid jumping the ATV as loss of control and damage to the ATV may result.

### SLIDING AND SKIDDING



#### WARNING

Skidding or sliding improperly may cause you to lose control of this ATV. You may also regain traction unexpectedly, which may cause the ATV to overturn.

Care should be used when riding on loose or slippery surfaces since the ATV may slide. If unexpected and uncorrected, sliding could lead to an accident.

To reduce the tendency for the front wheels to slide in loose or slippery conditions, positioning your weight over the front wheels will sometimes help.

If the rear wheels of your ATV start to slide sideways, control can usually be regained by steering in direction of the slide. Applying the brakes or accelerating is not recommended until you have corrected the slide.

With practice, over a period of time, skill at controlled sliding can be developed. The terrain should be chosen carefully before attempting such maneuvers since both stability and control are reduced.

Bear in mind that sliding maneuvers should always be avoided on extremely slippery surfaces, such as ice, since all control may be lost.

### CROSSING ROADS

Use extreme caution while crossing a road, avoid if at all possible. If you must cross a road:

1. Stop completely before crossing a road.
2. Check both directions for oncoming traffic.
3. NEVER attempt to cross a road or intersection at a blind crossing.
4. Drive straight across to the opposite side.
5. Allow plenty of time to safely cross the road.
6. Know your state and local laws. It is illegal to cross public roads in some places.

## Operation

### COLD WEATHER OPERATION

**NOTE:** Ensure all control levers operate as intended. Make sure the footrests are free and clear of ice and snow.



### WARNING

For your personal safety, it is important to wear the proper type and amount of cold-weather clothing according to the coldest anticipated temperatures.

1. With the brake lever lock released, move the ATV forward and backward to ensure the wheels roll freely. If the ATV does not move, the tires may be frozen to the ground or the brake shoes may be frozen to the drums.
2. If the tires are frozen to the ground, pour warm water around them to melt any ice around the tires.



### CAUTION

Before operating, manually move the ATV forward and backward to ensure the wheels roll freely.

3. If the brakes are frozen, move the ATV to a warm location to thaw out the brakes.



### WARNING

For your personal safety, do not attempt to free frozen brakes by pouring warm water on the brakes.

**NOTE:** After the brakes have thawed, dry them by compressing the brake lever several times while riding slowly.

**NOTE:** After riding through snow, slush, water or mud, it is recommended to dry the brake system before parking the ATV.



### WARNING

For your personal safety, go slow and be extra careful while riding on snow or ice-covered terrain. Always be alert to the changing terrain while operating the ATV.

4. Practice driving in an open snow or ice-covered area at slow speeds.
5. Learn how the ATV responds to steering and braking on snow or ice-covered terrain.

### Stopping the ATV

To stop the ATV, release the throttle lever and gradually apply both the front and rear brakes.

### Stopping the Engine

To stop the engine, slide the engine stop switch to the "OFF" position or turn the ignition switch key to the "OFF" position.



### CAUTION

Always leave the ignition switch in the "OFF" position when the engine is not running. Leaving the ignition switch in the "ON" position when the engine is not running may cause the battery to discharge.

## SECTION 8

### General Maintenance

**NOTE:** Proper maintenance of the ATV is extremely important for the safe operation and optimum performance. Follow the Maintenance Schedule and all ensuing maintenance instructions/information.

Inspection, adjustment and lubrication will keep your vehicle in the safest and most efficient condition possible.

Safety is an obligation of the vehicle owner/operator.



#### **WARNING**

Failure to properly maintain the vehicle may increase your risk of injury or death during service or while using the vehicle. If you are not familiar with vehicle service, have a dealer perform the service.



#### **WARNING**

Turn off the engine when performing maintenance unless otherwise specified.

- A running engine has moving parts that can catch on body parts or clothing and electrical parts that can cause shocks or thermal events.
- Running the engine while servicing can lead to eye injury, burns, a thermal event or carbon monoxide poisoning or death.



#### **WARNING**

Brake discs, calipers, drums and linings can become very hot during use. To avoid possible burns, let brake components cool before touching them.

The intervals given in the scheduled maintenance charts should apply to normal riding conditions. However, depending on the weather, terrain, geographical location and individual use, the maintenance intervals may need to be shortened.

You may choose any qualified repair shop or person to maintain, replace, or repair emission control devices and systems with original or equivalent replacement parts. However, warranty, recall and all other services paid for by Argo USA must be performed at an authorized Argo USA service center which will complete repairs in a reasonable amount of time. Argo USA service centers can provide all manner of service.

Ensure the service book is stamped and signed. Failure to do so could invalidate your warranty.

The maintenance schedule is based on months of use or kilometers/miles traveled, whichever comes first.

## Maintenance Schedule

Item	INITIAL	EVERY	
	1 month 100 mi (160 km)	6 months 600 mi (965 km)	1 year 1200 mi (1930 km)
* Air Filter	C, L	R	
Air Cleaner Drain Tube	I	I	
Brakes	I	I	
* Brake Fluid	I	I	
	Replace every 2 years		
Brake Hoses	I	I	
	Replace every 4 years		
Chassis Bolts and Nuts	T	T	
Chassis Lubrication Points	L	L	
C.V.T. (Drive) Belt			I
Drive Shafts / Universal Joints	I, L	I, L	
Engine Mounts	I	I	
* Engine Oil / Filter	R	R	
Engine Oil Strainer	C	C	
Exhaust / Muffler	I, T	I, T	
Front Differential / Rear Gearcase Oil	R	R	
Fuel Filter			R
Fuel Line		I	
	Replace every 4 years		
Intake / Exhaust Valves	I	I	
Rim / Hub	I	I	
Shock Absorbers	I	I	
Spark Arrester	I, C	I, C	
Spark Plug		I	R
Steering System	I	I	
Throttle Cable Free Play	I	I	
Tires	I	I	

**I** = Inspect, clean, adjust, lubricate, replace as necessary    **C** = Clean    **L** = Lubricate

**R** = Replace    **T** = Tighten

\* - For vehicles subjected to severe riding conditions, the maintenance period of inspecting, cleaning or lubricating may require a shorter time interval as necessary.

## General Maintenance

### Jacking Point

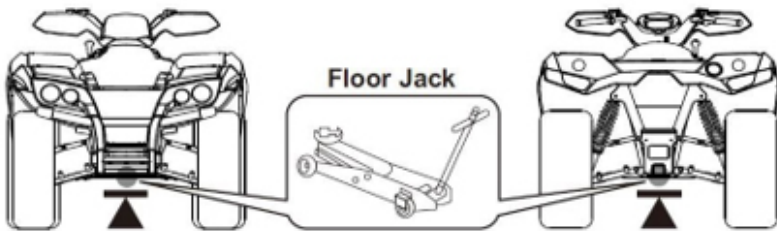

- When raising your vehicle Make sure to observe the following to reduce the possibility of death or serious injury.
- Lift up the vehicle using a floor jack such as the one shown in the illustration.
- Do not put any part of your body or get underneath the vehicle supported only by the floor jack.
- Always use floor jack and ATV jack stands on a solid, flat, level surface.
- Do not start the engine while the vehicle is supported by the floor jack.
- Stop the vehicle on level firm ground, firmly set the parking brake and shift the shift lever in P.
- Do not raise the vehicle while someone is in the vehicle.
- When raising the vehicle, do not place any objects on top of or underneath the floor jack.

### Grease Point

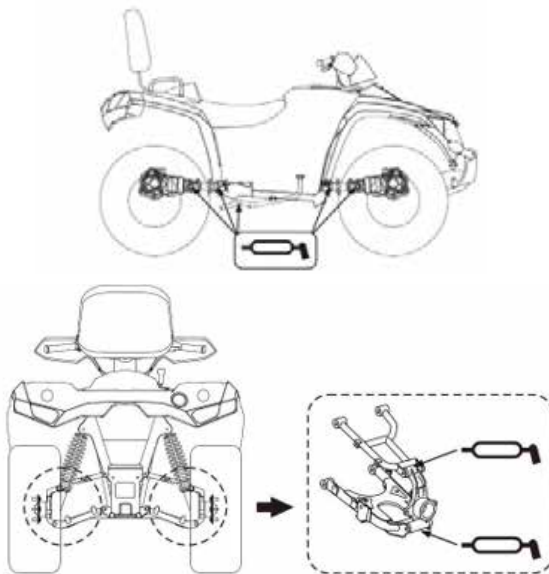

## General Maintenance

### Coolant Change

#### Recommended antifreeze:

High quality ethylene glycol antifreeze containing corrosion inhibitors for aluminum engines

#### Coolant quantity:

**Radiator capacity (including all routes):** 2.3 qt (2.2 L)

**Reservoir capacity (up to the maximum level mark):** 1.25 qt (1.2 L)



### WARNING

Wait for the engine and radiator to cool before removing the radiator cap. You could be burned by hot fluid and steam blown out under pressure. Always place a thick rag over the cap when opening. Allow any remaining pressure to escape before completely removing the cap.

1. Place the ATV on a level surface.
2. Remove front cover.
3. Place a container under the engine and then remove the coolant drain bolt and gasket.
4. Remove the radiator cap.
5. Remove reservoir cap.
6. Disconnect the coolant reservoir hose on the coolant reservoir side and then drain the coolant from the coolant reservoir.
7. After draining the coolant, thoroughly flush the cooling system with clean tap water.
8. Install the coolant drain bolt and its new gasket and then tighten the bolt.
9. Connect the coolant reservoir hose.
10. Pour the recommended coolant into the reservoir to the maximum level mark and then install the reservoir cap.



### CAUTION

Mix antifreeze with distilled water only. However, if distilled water is not available, soft water may be used for refilling. Do not use hard water since it is harmful to the engine.

11. Pour the recommended coolant into the radiator until it is full. Antifreeze/water mixture ratio: 1:1
12. Install the radiator cap, start the engine let it idle for several minutes and then turn it off.
13. Remove the radiator cap to check the coolant level in the radiator. If it is low, add sufficient coolant until it reaches the top of the radiator then install the radiator cap.
14. Start the engine and then check for coolant leakage.
15. Install the front cover.

## General Maintenance

### Spark Plug Inspection

**Standard Spark Plug:** NGK DCR8E

**Spark Plug Gap:** 0.027 - 0.031 in. (0.7 - 0.8 mm)

**Spark Plug Torque:** 13 ft. lb. (17.6 Nm)

The spark plug is an important engine component and is easy to inspect. The condition of the spark plug can indicate the condition of the engine. For example, a very white center electrode porcelain color could indicate an intake air leak or carburation problem for that cylinder. Do not attempt to diagnose such problems yourself. Instead, take the machine to an authorized ARGO dealer. You should periodically remove and inspect the spark plug because heat and deposits will cause the spark plug to slowly break down and erode. If electrode erosion becomes excessive, you should replace the spark plug with one of the proper type.

#### To remove the spark plug:

1. Remove spark plug cap.
2. Remove dirt and debris from around the spark plug.
3. Remove the spark plug with spark plug wrench.

#### To check the spark plug:

1. Check that the porcelain insulator around the center electrode of the spark plug is a medium to light tan (the ideal color when the ATV is ridden normally).

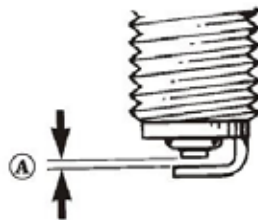

A. Spark plug gap

**NOTE: If the spark plug shows a distinctly different color, the engine could be operating improperly. Do not attempt to diagnose such problems yourself. Take the vehicle to an authorized ARGO dealer.**

2. Check the spark plug for electrode erosion and excessive carbon or other deposits and replace it if necessary.
3. Measure the spark plug gap with a wire thickness gauge and if necessary, adjust the gap to specification.

#### To install the spark plug:

1. Clean the surface of the spark plug gasket and its mating surface and then wipe off any dirt from the spark plug threads.
2. Install the spark plug with the spark plug wrench and then tighten it to the specified torque.

**NOTE: If a torque wrench is not available when installing the spark plug, a good estimate of the correct torque is 1/4-1/2 turn past finger tight.**

3. Install the spark plug cap.



## General Maintenance

### Air Cleaner

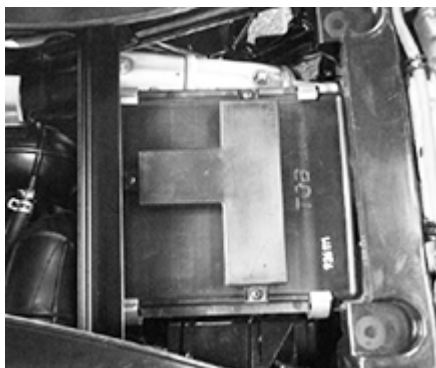

1. Remove the seat.
2. Release the four latches that secure the air cleaner cover, remove the cover.
3. Loosen the clamp strip screw and remove the air cleaner element.
4. Clean the element with a non-flammable solvent and then squeeze it completely dry.



#### CAUTION

Do not twist the sponge material when squeezing it.  
Apply foam air filter oil or other quality foam air filter oil to the sponge material.



#### WARNING

Always use parts cleaning solvent to clean the sponge material. Never use low-flash-point solvents or gasoline to clean the sponge material because the engine could create a thermal event or explode.



#### WARNING

##### POTENTIAL HAZARD

Using low flash point solvents or gasoline to clean the air filter element.

##### WHAT CAN HAPPEN

Low flash point solvents or gasoline can cause a thermal event or explode increasing the risk of an accident or injury.

##### HOW TO AVOID THE HAZARD

Use parts cleaning solvent to clean the air filter element.

5. Apply foam air filter oil or other quality foam air filter oil to the sponge material.
- NOTE: The sponge material should be wet but not dripping with oil.**

## General Maintenance

### Engine Oil and Filter

The engine oil level should be checked before each ride. In addition, the oil must be changed and the oil filter replaced at the intervals specified in the periodic maintenance and lubrication chart.

#### To check the engine oil level:

1. Place the ATV on a level surface.
2. Check the engine oil level on a cold engine.

**NOTE: If the engine was started before checking the oil level, be sure to warm up the engine sufficiently and then wait at least ten minutes until the oil settles for an accurate reading.**

3. Remove the engine oil filler cap then wipe the engine oil dipstick off with a clean cloth.

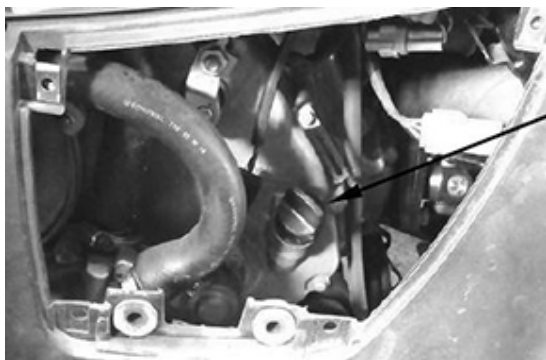

Oil Fill Plug



Oil Level Reading

4. Insert the dipstick into the filler hole (by screwing it in) and then remove it again to check the oil level.

**NOTE: The engine oil should be between the tip of the dipstick and the maximum level mark.**

5. If the engine oil is not between the tip of the dipstick and the maximum level mark, add sufficient oil of the recommended type to raise it to the correct level.

**NOTE: Be sure the engine oil is at the correct level, otherwise engine damage may result.**

6. Insert the dipstick into the oil filler hole and then tighten the engine oil filler cap.

## General Maintenance

### To change the engine oil (with or without oil filter replacement):

1. Place the ATV on a level surface.
2. Start the engine and let warm up for several minutes and then turn off.
3. Using a suitable jack, elevate the ATV. Support the ATV on a support stand.



### **WARNING**

Ensure the ATV is safely supported on the stand to avoid injury.



4. Place an oil pan under the engine to collect the used oil.
5. Remove the engine oil drain bolt and its gasket to drain the oil from the crankcase.

**NOTE:** Skip the steps 6-8, if the oil filter cartridge is not being replaced.

**NOTE:** Dispose of lubricant in accordance with local regulations.

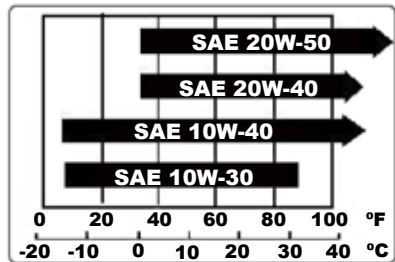

6. Remove the left internal fender.
7. Remove the oil filter cartridge with an oil filter wrench.
8. Apply a thin coat of engine oil to the O-ring of new oil filter.
9. Install the new oil filter and tighten securely.
10. Install the engine oil drain bolt and new gasket. Tighten the bolt to 16.5 ft. lb (22.5 Nm).
11. Refill with the specified amount of the recommended engine oil. Install the engine oil filler cap and tighten securely.

**NOTE:** Be sure to wipe up any spilled oil on any parts after the engine and exhaust system have cooled down.



### **CAUTION**

Ensure no foreign material enters the crankcase.

In order to prevent clutch slippage (since the engine oil also lubricates the clutch), do not mix any chemical additives.

12. Start the engine and then let it idle for several minutes while checking it for oil leakage. If oil is leaking, immediately turn the engine off and check for the cause.
13. Turn the engine off, wait at least ten minutes and then check the oil level and correct it if necessary.

## General Maintenance

### Front Differential Gear Oil

The front differential gear case level should be checked for oil leakage before each ride. If any leakage is present, take the ATV to an authorized ARGO dealer for service. In addition, the differential gear oil level must be checked and the oil changed following the interval schedule in the periodic maintenance and lubrication chart.

#### To check the front differential gearcase oil level:

1. Place the ATV on a level surface.
2. Remove the front differential gearcase oil filler bolt and its gasket. Check the oil level in the front differential gear case. The oil level should be at the bottom of the filler hole.

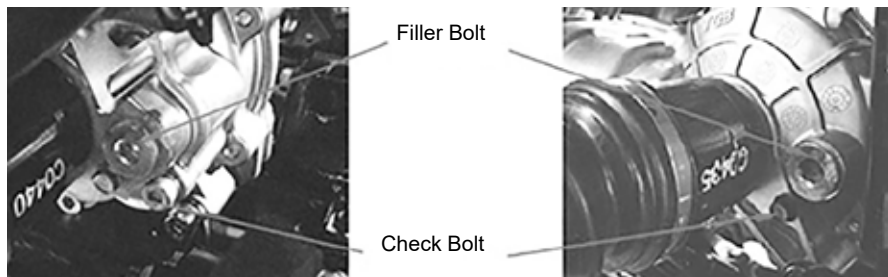

3. If the oil is below the bottom of the filler hole, add sufficient oil (85W90) to raise it to the correct level.
4. Check the gasket for damage and replace it if necessary.
5. Install the oil filler bolt and its gasket and then torque to specification.

#### To change the front differential gear oil:

1. Place the ATV on a level surface.
2. Using a suitable jack, elevate the ATV. Support the ATV on a support stand.



### **WARNING**

Ensure the ATV is safely supported on the stand to avoid injury.

3. Place an oil pan under the front differential gear case to collect the used oil.
4. Remove the front differential oil filler bolt, the differential oil drain bolt and their gaskets to drain the oil from the differential gear case.

#### **NOTE: Dispose of lubricant in accordance with local regulations.**

5. Install the drain bolt and its new gasket and tighten the bolt to the specified torque.
6. Refill with recommended differential gear oil.
7. Check the oil filler bolt gasket for damage and replace if necessary.



## General Maintenance

8. Install the oil filler bolt and its gasket and tighten the bolt to 24 ft lb (32.4 Nm).
9. Check the differential gearcase for oil leakage. If oil is leaking, check for the cause.

### Rear Gearcase Oil

The rear gearcase level should be checked for oil leakage before each ride. If any leakage is present, take the ATV to an authorized ARGO dealer for service. In addition, the rear gear oil level must be checked and the oil changed following the interval schedule in the periodic maintenance and lubrication chart.

#### To check the rear gearcase oil level:

1. Place the ATV on a level surface.
2. Remove the rear gearcase oil filler bolt and its gasket. Check the oil level in the rear gearcase. The oil level should be at the bottom of the filler hole.



3. If the oil is below the bottom of the filler hole, add sufficient oil to raise it to the correct level.
4. Check the gasket for damage and replace it if necessary.
5. Install the oil filler bolt and its gasket and then tighten to 24 ft lb (32.36 Nm).

#### To change the rear gearcase oil:

1. Place the ATV on a level surface.
2. Using a suitable jack, elevate the ATV. Support the ATV on a support stand.



### **WARNING**

Ensure the ATV is safely supported on the stand to avoid injury.

3. Place an oil pan under the rear gearcase to collect the used oil.
4. Remove the rear gearcase oil filler bolt, the rear gearcase oil drain bolt and their gaskets to drain the oil from the rear gearcase.

**NOTE: Dispose of lubricant in accordance with local regulations.**

5. Install the drain bolt and its new gasket and tighten the bolt to the specified torque.
6. Refill with recommended gear oil to the bottom of the filler hole.

## General Maintenance

7. Check the oil filler bolt gasket for damage and replace it if necessary.
8. Install the oil filler bolt and gasket and then tighten to the specified torque.
9. Check the rear gearcase for oil leakage. If oil is leaking, check for the cause.

## Battery

The battery is located under the seat. This model is equipped with a maintenance free battery. There is no need to check the electrolyte or to add distilled water. However, the battery lead connections need to be checked and tightened if necessary following the periodic maintenance table.



### WARNING

**Battery electrolyte is poisonous and dangerous as it contains sulfuric acid, which can cause severe burns. Avoid contact with skin, eyes or clothing. Always shield your eyes when working near batteries.**

**Batteries produce explosive gases. Keep sparks, flame, cigarettes or other sources of ignition away. Ventilate when charging or using in an enclosed space.**

**KEEP OUT OF REACH OF CHILDREN**

### To remove the battery:

1. Remove the seat.
2. Remove the battery holding plate by removing the bolts.
3. Remove the NEGATIVE battery bolt and disconnect the negative battery lead first, then remove the POSITIVE battery bolt and disconnect the positive battery lead.
4. Remove the battery from the battery compartment.



### CAUTION

- Do not attempt to remove the caps from the battery cells as this may damage the battery.
- Although the battery is sealed, it vents explosive gases and should be handled with appropriate care.

## General Maintenance

### To install the battery:

1. Place the battery in its compartment.
2. Connect the POSITIVE battery lead first then connect the NEGATIVE battery lead.



### **CAUTION**

When installing a battery, the main power switch must be turned to the "OFF" position and the positive lead must be connected before the negative lead.

3. Install the battery holding plate by installing the bolts.
4. Install the seat.

### To charge the battery:

Have an authorized ARGO dealer charge the battery as soon as possible if it seems to have discharged. Keep in mind that the battery tends to discharge more quickly if the ATV is equipped with optional electrical accessories.



### **CAUTION**

To charge a maintenance free battery, a special (constant voltage) battery charger is required. Using a conventional battery charger will damage the battery.

### To store battery:

1. If the ATV will not be used for more than one month, remove the battery, fully charge it and then place it in a cool dry place.
2. If the battery will be stored for more than two months, check it at least once a month and fully charge it if necessary.



### **CAUTION**

Always keep the battery charged. Storing a discharged battery can cause permanent damage to the battery.



### **WARNING**

#### **POTENTIAL HAZARD**

Allowing open flames or sparks near the battery.

#### **WHAT CAN HAPPEN**

Gases may explode and possibly cause injury.

#### **HOW TO AVOID THE HAZARD**

Do not allow open flames or sparks near the battery.

### **NOTE:**

- When the ATV is to be stored for an extended period, remove the battery from the vehicle and charge it fully. Then store it in a cool, dry place. If the battery is to be left on the vehicle, disconnect the negative cable from the battery terminal.
- Battery posts, terminals and related accessories contain lead and lead compounds. **Wash hands after handling.**

## General Maintenance

### Charging / Maintenance Charging

**NOTE:** ARGO recommends the use of a battery charger/maintainer. Maintenance charging is required on all batteries not used for more than two weeks or as required by battery drain.

1. When charging a battery in the vehicle, be sure the ignition switch is in the OFF position.
2. Clean the battery terminals with a solution of baking soda and water.

**NOTE:** The sealing strip should NOT be removed and NO fluid should be added.

3. Ensure the charger and battery are in a well-ventilated area and the charger is unplugged from the 110-volt electrical outlet.
4. Connect the red terminal lead from the charger to the positive (+) terminal of the battery; then connect the black terminal lead of the charger to the negative (-) terminal of the battery.
5. Plug the battery charger/maintainer into a 110-volt electrical outlet.
6. Follow charging instructions supplied with the charger/maintainer.

**NOTE:** Not using a battery charger with the proper float maintenance will damage the battery if connected over extended periods

7. Once the battery has reached full charge, unplug the charger from the 110-volt electrical outlet.

**NOTE:** If, after charging, the battery does not perform to operator expectations, bring the battery to an authorized ARGO dealer for further troubleshooting.

### Jump-Starting

**NOTE:** ARGO does not recommend jump-starting a vehicle with a dead battery but rather to remove the battery, service it, and correctly charge it.



#### **WARNING**

Improper handling or connecting of a battery may result in severe injury including acid burns, electrical burns, or blindness as a result of an explosion. Always remove rings and watches.



#### **WARNING**

Any time service is performed on a battery, the following must be observed: keep sparks, open flame, cigarettes, or any other flame away. Always wear safety glasses. Protect skin and clothing when handling a battery. When servicing battery in enclosed space, keep the area well ventilated. Make sure battery venting is not obstructed.



## General Maintenance

### Fuses

There are two fuse boxes on this model, one is the main fuse box and the other is the EPS fuse box.

For **EPS** model, the MAXI fuse is located in the EPS fuse box which is under the seat on the right side of the ATV.

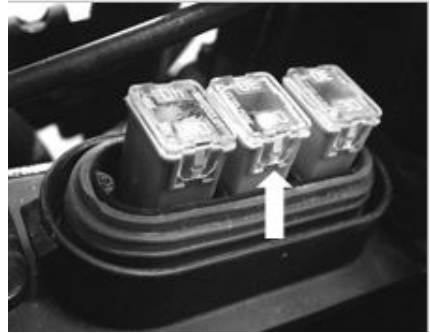

### Replacing a fuse:

The main fuse box and the EPS fuse box are located under the seat.

HEAD HI 15A	IGNITION 10A	TAIL 10A	F.P. RELAY
HEAD LO 15A	P-SOURCE 10A	SPACE FUSE 20A	
FUEL PUMP 10A	P-SOURCE 10A	FAN RELAY	MAIN P. RELAY
EFI SYSTEM	FAN 20A		



EPS 40A	MAXI 30A	CHARGER 30A
GREEN	PINK	PINK



If a fuse is blown, replace it as follows:

1. Turn the key to the "OFF" position and turn off all electrical circuits.



### CAUTION

To prevent accidental short circuiting, turn off the main power switch before checking or replacing fuses.

2. Remove the blown fuse and install a new fuse of the same specified amperage.



### WARNING

Always use a fuse of the specified rating and never use a substitute object in place of the proper fuse. An improper fuse or a substitute object can cause damage to the electrical system.

## General Maintenance

3. Turn the key to the "ON" position and turn on the electrical circuits to check if the devices operate.
4. If the fuse immediately blows again, have an authorized ARGO dealer check the electrical system.

### Replacing a Headlight Bulb

If a headlight bulb burns out, replace it as follows:

1. Disconnect the wiring connector.
2. Carefully turn the headlight bulb counter-clockwise to remove.

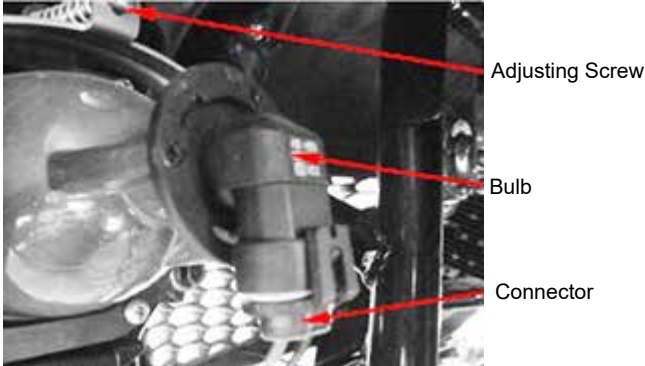

3. Insert a new headlight bulb, and turn clockwise to lock in place.
4. Connect the wiring connector.



### CAUTION

Do not touch the glass part of the headlight bulb to keep it free from oil, otherwise the transparency of the glass; the luminosity of the bulb and the bulb life will be adversely affected. Thoroughly clean off any dirt and fingerprints on the headlight bulb using a cloth moistened with alcohol or thinner.

5. Adjust the headlight beam if necessary.

## General Maintenance

### Adjusting a Headlight Beam



## CAUTION

It is advisable to have an authorized ARGO dealer perform this adjustment.

To raise a headlight beam, turn the headlight beam adjusting screw in clockwise.  
To lower a headlight beam, turn the adjusting screw in counter-clockwise.

### Replacing Tail/Brake Light Bulb

If the tail /brake light bulb burns out, replace it as follows:

1. Remove the cover on the rear of the tail/brake light.

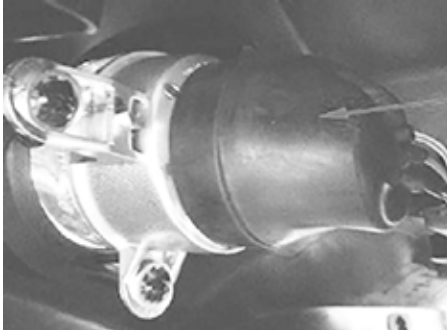

Cover

2. Remove the tail/brake light bulb holder (together with bulb) by rotating the holder counter-clockwise.

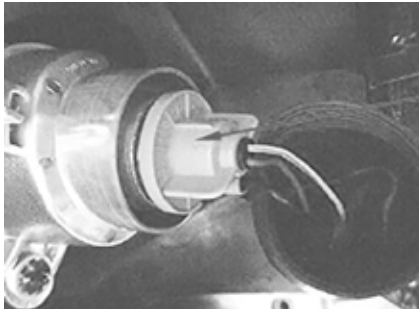

Holder

3. Remove the bulb by gently pushing in and rotating counter-clockwise.
4. Insert new bulb into the bulb holder, gently push in and rotate clockwise until it stops.
5. Install the bulb holder (together with bulb) into tail/brake light assembly by rotating the holder clockwise.
6. Install the cover.

## General Maintenance

### Shock Absorbers

Each shock absorber should be visibly checked weekly for excessive fluid leakage (some seal leakage may be observed but does not indicate the shock is in need of replacement), cracks or breaks in the lower case, or a bent shock rod. If any one of these conditions is detected, replacement is necessary.

**NOTE: When the ATV is operated in extremely cold weather (-10°F/-23°C or colder), a small amount of leakage may be present. Unless the leakage is excessive, replacement is not necessary.**

### Throttle Lever Adjustment

**NOTE:** Adjust the engine idle speed before adjusting the throttle lever free play.

To adjust throttle free play:

1. Slide the rubber sleeves back to expose the throttle cable adjuster.
2. Loosen the lock nut, then turn the adjuster to obtain the correct free play. (0.12 - 0.2 in (3 - 5 mm)).
3. Tighten the locknut and reinstall the sleeve.

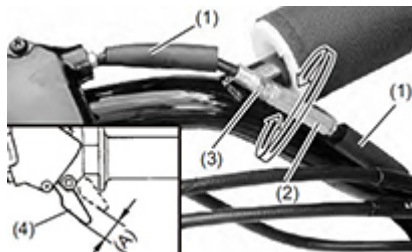

1. Rubber sleeve
  2. Cable adjuster
  3. Locknut
  4. Throttle lever
- (A) 0.12 - 0.2 in (3 - 5 mm)

### Cable Inspection and Lubrication

Lubricate the inner cables and the cable ends with a quality cable lubricant. If the cables do not operate smoothly, see an authorized ARGO dealer to replace them.

### Front Brake Lever Free Play Adjustment

**Specified free play:** 0.4 - 0.8 in (10 - 20 mm)

The front brake lever free play should be adjusted to 0.4 - 0.8 in (10~20 mm) at the tip of the brake lever. If the free play is incorrect, adjust as follows:

1. Loosen the upper locknut and fully turn the adjustment bolt.
2. Loosen the lower locknut.
3. Turn the lower adjusting bolt until specified free play is obtained.
4. Tighten the lower locknut.
5. While applying the front brake, turn out the upper adjusting bolt until the upper and lower cable lengths are equal. The cable joint will become vertical.
6. Tighten the upper locknut.

## General Maintenance



### WARNING

#### POTENTIAL HAZARD

Operating with improperly serviced or adjusted brakes.

#### WHAT CAN HAPPEN

You could lose braking ability, which could increase the risk of an accident or injury.

#### HOW TO AVOID THE HAZARD

After servicing:

Make sure the brakes operate smoothly and the free play is correct.

Make sure the brakes do not drag.

Replacement of brake components require professional knowledge. These procedures should be performed by an authorized ARGO dealer.

## Brake Lever Lubrication

### Recommended Lubrication:

Lithium-soap-based grease (all purpose)

Lubricate the pivoting points of the brake levers.

## Brake Fluid Inspection

Check if the fluid level is below the lower level mark through the inspection window.

1. Lower level mark (Hand brake lever)

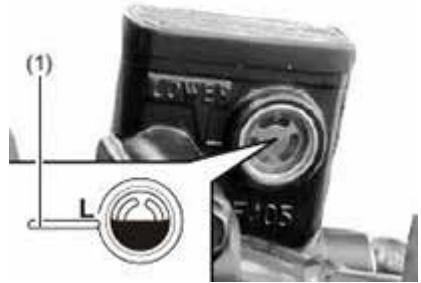

### WARNING

#### POTENTIAL HAZARD

Brake fluid contacting the skin or eyes.

#### WHAT CAN HAPPEN

May cause irritation or injury.

#### HOW TO AVOID THE HAZARD

Avoid contacting brake fluid with the skin or eyes. In case of contact, flush thoroughly with water and call a doctor if your eyes were exposed.

### NOTE:

As the brake pads wear, brake fluid level drops, automatically compensating for wear. There are no adjustments to perform, but fluid level and pad wear must be inspected periodically. The system must be inspected frequently to ensure there are no fluid leaks.

If the brake lever travel become excessive and the brake pads are not worn beyond the recommended limit, there is probably air in the brake system and it must be bled. See your authorized ARGO dealer for this service.

## General Maintenance



### CAUTION

- To prevent damage to the brake system, use only fluid from a sealed container. Never allow contaminants (dirt, water, etc.) to enter the brake fluid reservoir.
- Brake fluid can damage paint and plastic, so handle the fluid with care. When adding brake fluid, be sure the reservoir is horizontal before removing the cover to prevent accidental spilling.
- Use only DOT 4 brake fluid from a sealed container.



### WARNING

#### POTENTIAL HAZARD

Damaged control cables.

#### WHAT CAN HAPPEN

Corrosion can result when the outer covering of control cables becomes damaged.

Cables can also become frayed or kinked.

Operation of controls could be restricted, which could cause accident or injury.

#### HOW TO AVOID THE HAZARD

Inspect cables frequently. Replace damaged cables.

## Wheel - Removal and Installation

1. Park the ATV on level ground and move shift lever to the “P” position.
2. Loosen the wheel nuts on the wheel to be removed. Do not remove the wheel nuts from the wheel studs.
3. Using a suitable jack, elevate the ATV. Support the ATV on a support stand.



### WARNING

Ensure the ATV is safely supported on the stand to avoid injury.

4. Remove the wheel nuts.
5. Remove the wheel.
6. Install the wheel and install wheel nuts.
7. Tighten in a crisscross pattern to 30 ft-lb.
8. Remove the support stand and the jack.



### WARNING

Use of improper tires on this ATV may cause loss of control, increasing your risk of an accident.

Never attempt to change the tires without profession knowledge or skill. It will increase the risk of accident. Please contact your dealer for properly tires change.

## General Maintenance

### Aftermarket Tires and Rims

The tires and rims that came with your ATV were designed to match the performance capabilities and to provide the best combination of handling, braking and comfort. Other tires, rims, sizes and combinations may not be appropriate.

### Spark Arrester Cleaning

Be sure the exhaust pipe and muffler are cool before cleaning the spark arrester.

1. Remove the bolts.
2. Remove the tailpipe by pulling it out of the muffler.
3. Tap the tailpipe lightly, then use a wire brush to remove any carbon deposits from the spark arrester portion of the tailpipe and inside the tailpipe housing.
4. Insert the tailpipe into the muffler and align the bolt holes.
5. Install the bolts. Tighten to 8 in lb (1 Nm).

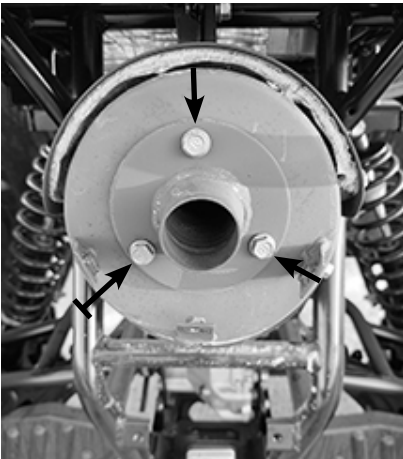

## WARNING

### POTENTIAL HAZARD

Improper cleaning of the spark arrester.

### WHAT CAN HAPPEN

Could injure the eyes.

Could cause burns.

Could cause carbon monoxide poisoning, possible leading to death.

Could create a thermal event.

### HOW TO AVOID THE HAZARD

When cleaning the spark arrester:

Always let the exhaust system cool prior to touching exhaust components.

Do not start the engine when cleaning the exhaust system.

### NOISE REGULATION

#### TAMPERING WITH NOISE CONTROL SYSTEM PROHIBITED:

Federal law prohibits the following acts or the causing thereof: (1) The removal or rendering inoperative by any person other than for purposes of maintenance, repair, or replacement of any device or element of design incorporated into any new vehicle for the purpose of noise control prior to its sale or delivery to the ultimate purchaser or while it is in use or (2) the use of the vehicle after such device or element of design has been removed or rendered inoperative by any person.

“AMONG THOSE ACTS PRESUMED TO CONSTITUTE TAMPERING ARE THE ACTS LISTED BELOW”.

These acts include tampering with the following systems; i.e., modification, removal, etc.

Exhaust system: Muffler  
Exhaust pipe  
Silencer

Intake system: Air cleaner case  
Air cleaner element  
Intake duct



## NOTES

## Troubleshooting

<b>Engine doesn't turn over</b>	
<b>Possible Cause</b>	<b>Solution</b>
Tripped circuit breaker	Reset the breaker
Low battery voltage	Recharge battery to 12.5 VDC
Loose battery connections	Check all connections and ignition
Loose solenoid connections	Check all connections and ignition
<b>Engine turns over but fails to start</b>	
<b>Possible Cause</b>	<b>Solution</b>
Out of fuel	Refuel
Clogged fuel filter	Inspect, clean or replace
Water is present in fuel	Drain the fuel system and refuel
Fouled or defective spark plug	Inspect plug, replace if necessary
Crankcase filled with water or fuel	Immediately see your dealer
Low battery voltage	Recharge battery to 12.5 VDC
Mechanical failure	See your dealer
<b>Engine pings or knocks</b>	
<b>Possible Cause</b>	<b>Solution</b>
Poor quality or low octane fuel	Replace with recommended fuel
Incorrect ignition timing	See your dealer
Incorrect spark plug gap or heat range	Set gap to specs or replace plug
<b>Engine backfires</b>	
<b>Possible Cause</b>	<b>Solution</b>
Weak spark from spark plug	Inspect, clean and/or replace spark plug
Incorrect spark plug gap or heat range	Set gap to specs or replace plug
Old or non-recommended fuel	Replace with new fuel
Incorrectly installed spark plug wire	See your dealer
Incorrect ignition timing	See your dealer
Mechanical failure	See your dealer
<b>Engine runs irregularly, stalls or misfires</b>	
<b>Possible Cause</b>	<b>Solution</b>
Fouled or defective spark plug	Inspect, clean and/or replace spark plug
Worn or defective spark plug wire	See your dealer
Incorrect spark plug gap or heat range	Set gap to specs or replace plug
Loose ignition connection	Check all connections and tighten
Water present in fuel	Replace with new fuel

## Troubleshooting

Possible Cause	Solution
Low battery voltage	Recharge battery to 12.5 VDC
Kinked or plugged fuel vent line	Inspect and replace
Incorrect fuel	Replace with recommended fuel
Clogged air filter	Inspect, clean or replace
Other mechanical failure	See your dealer
<b>Possible lean mixture fuel cause</b>	
Low or contaminated fuel	Add or change fuel, clean fuel system
Low octane fuel	Replace with recommended fuel
Clogged fuel filter	Replace filter
<b>Possible rich mixture fuel cause</b>	
Fuel is very high octane	Replace with lower octane fuel
<b>Engine stops or loses power</b>	
Possible Cause	Solution
Out of fuel	Refuel
Kinked or plugged fuel vent line	Inspect and replace
Water present in fuel	Replace with new fuel
Fouled or defective spark plug	Inspect, clean and/or replace spark plug
Worn or defective spark plug wire	See your dealer
Incorrect spark plug gap or heat range	Set gap to specs or replace plug
Loose ignition connection	Check all connections and tighten
Low battery voltage	Recharge battery to 12.5 VDC
Incorrect fuel	Replace with recommended fuel
Clogged air filter	Inspect, clean or replace
Other mechanical failure	See your dealer
Overheated engine	Clean engine exterior See your dealer

## SECTION 9

### Preparation For Storage



#### CAUTION

Prior to storing your ATV, it must be properly serviced to prevent rusting and component deterioration.

#### Cleaning the Vehicle

Frequent, thorough cleaning of your ATV will not only enhance its appearance but will improve its general performance and extend the useful life of many components.

1. Before cleaning the ATV:
  - a. Block off the end of the exhaust pipe to prevent water entry. A plastic bag and strong rubber band may be used.
  - b. Make sure the spark plug and all filler caps are properly installed.
2. If the engine case is excessively greasy, apply degreaser with a paintbrush. Do not apply degreaser to wheel axles.
3. Rinse the dirt and degreaser off with a garden hose. Use only enough pressure to do the job.



#### WARNING

- Wet brakes may have reduced stopping ability, increasing the chance of an accident. Test the brakes after washing. Apply the brakes several times at slow speeds to let friction dry out the linings.
- Excessive water pressure may cause water seepage and deterioration of wheel bearing, brakes, transmission seals and electrical devices. Many expensive repair bills have resulted from improper high-pressure detergent applications such as those available in coin-operated car washes.

4. Once most of the dirt has been hosed off, wash all surfaces with warm water and mild, detergent-type soap. An old toothbrush or bottle brush is handy for hard to reach places.
5. Rinse the ATV off immediately with clean water and dry all surfaces with a chamois, clean towel or soft absorbing cloth.
6. Clean the seat with vinyl upholstery cleaner to keep the cover pliable and glossy.
7. Automotive type wax may be applied to all painted and chrome plated surfaces. Avoid combination cleaner-waxes. Many contain abrasives, which may mar the paint or protective finish. When finished cleaning, start the engine and let it idle for several minutes.

## Storage

### Short Term

Always store your ATV in a cool, dry place and if necessary, protect it against dust with a porous cover.



### WARNING

Storing the ATV in a poorly ventilated room or covering it with a tarp while it is still wet, will allow water and humidity to seep in and cause rust. To prevent corrosion, avoid damp cellars, stables and area where strong chemicals are stored.

### Long Term

Before storing your ATV for several months:

1. Follow all the instructions in the “Cleaning” section of this chapter.
2. Turn the fuel valve to “OFF”.
3. Fill up the fuel tank and add fuel stabilizer to prevent the fuel from deteriorating.
4. Perform the following steps to protect the cylinder, piston rings, etc. from corrosion.
  - a. Remove the spark plug cap and spark plug.
  - b. Pour a teaspoonful of engine oil into the spark plug bore.
  - c. Install the spark plug cap onto the spark plug and then place the spark plug on the cylinder head so that the electrodes are grounded.
  - d. Turn the engine over several times with the starter.
  - e. Remove the spark plug cap from the spark plug and then install the spark plug and the spark plug cap.
5. Lubricate all control cables and the pivoting points of all levers and pedals.
6. Check and if necessary, correct the tire air pressure and then block up the ATV so that all of its wheels are off the ground. Alternatively, turn the wheels a little every month in order to prevent the tires from becoming degraded in one spot.
7. Cover the muffler outlet with a plastic bag to prevent moisture from entering it.
8. Remove the battery and fully charge it. Store it in a cool, dry place and charge it once a month.

Do not store the battery in an excessively cold or warm place less than 32° F (0° C) or more than 86° F (30° C).
9. Make necessary repairs before storing the ATV.

## SECTION 10

### Warranty



#### **LIMITED WARRANTY**

Ontario Drive & Gear Limited (hereinafter "ARGO") extends a limited warranty on each new ARGO ATV, XTV or SSV, and on each genuine ARGO part and accessory sold by an authorized ARGO dealer. The limited warranty on an ARGO ATV, XTV or SSV is provided to the original retail purchaser; however, the balance of the unused warranty may be transferred to another party through an ARGO dealer, but any such transfer will not extend the original term of the warranty. Warranty coverage is limited to the country in which the original retail purchase occurs and to the original retail purchaser resident in that country or, if transferred to a resident in that country for the balance of the remaining warranty.

The warranty is validated upon examination of said parts by ARGO or an authorized ARGO dealer. ARGO reserves the right to inspect such parts at its factory for final determination if warranty should apply. ARGO will repair or replace, at its option (including any related labor charges), any parts that are found to be warrantable in material or workmanship. This repair work must be done by an authorized ARGO dealer. No transportation charges, rental charges, or inconvenience costs will be paid by ARGO.

ARGO does not assume any liability for incidental or consequential damages.

#### **WARRANTY COVERAGE PERIOD**

1. Standard Warranty - 1 year from the date of sale.

Argo Promotional Extended Warranty provided at the time of sale will follow the Standard Warranty guidelines and coverage. Excludes batteries.

The warranty does not cover normal wear, abuse, or corrosion.

#### **WARRANTY LIMITATIONS AND EXCLUSIONS**

This ARGO limited warranty will become null and void if:

1. Failure to perform the proper break-in procedure and all related maintenance, storage procedures (if stored for extended periods), and/or service as recommended in the Operator's Manual.
2. Repairs and/or adjustments made by anyone other than an authorized ARGO dealer unless instructed by ARGO.
3. Any modification, addition, or removal of parts unless instructed to do so by ARGO.
4. Removal of the engine for use in another vehicle.
5. Use of improper fuels, lubricating oils, or spark plug(s).
6. Vehicle has been involved in an accident or subject to misuse, abuse, or negligent operation, including overloading.
7. Use of the vehicle in any way for racing purposes.
8. Removal or mutilation of the Product Identification Number or Engine Serial Number.
9. Damage due to improper transportation.
10. Use of aftermarket or unapproved parts, accessories or attachments not sold by ARGO.



11. Damage caused by Acts of God, such as storm damage, hail, lightning, and other environmental conditions.
12. Collision, fire, theft, freezing, vandalism, riot, explosion, or objects striking the vehicle.
13. Tampering with the vehicle's hour meter.

In consideration of the foregoing, any implied warranty is limited in duration to the warranty periods set forth. This warranty gives you specific legal rights, and you may also have other rights which vary from state/province to state/province and country to country. Some jurisdictions do not allow limitations on how long an implied warranty lasts, so the above limitations may not apply to you.

### **WARRANTY PROCEDURE / OWNER RESPONSIBILITY**

At the time of sale, a Training Certificate (if applicable) or an Owner Registration form is to be completed by the selling dealer and consumer. The receipt of the form by ARGO is a condition precedent to warranty coverage. It is the selling dealer's responsibility to retain and/or submit appropriate electronic registration to initiate warranty coverage.

The selling dealer is responsible to furnish the consumer a signed copy of the form which must be presented to the dealer when requesting warranty service. The registration form is the consumer's proof of ownership and warranty eligibility. The form is to be used by the dealer to validate the warranty claim. Retain your copy of the Owner Registration form and keep it in a safe place.

When warranty repair is suspected, the vehicle should be taken to an authorized ARGO dealer, who has the primary responsibility to perform warranty repairs.

The authorized ARGO dealer will examine the vehicle or part to determine if a warrantable condition exists. If a warrantable condition appears to exist, the dealer will repair or replace, at ARGO's option, including any related labor costs, all parts that are found to be warrantable and any other parts which the warrantable part caused to be damaged.

It is the owner's responsibility to maintain and service the vehicle in accordance with ARGO's recommendations in the Operator's Manual. To protect yourself and your vehicle, follow all safety and service tips. ARGO will NOT warrant repairs required as a result of not performing standard operator maintenance, storage procedures, and service as outlined in the Operator's Manual.

Should you have any questions concerning the warranty, contact an authorized ARGO dealer.

## **EPA EMISSIONS CONTROL SYSTEM WARRANTY:**

### **LIMITED WARRANTIES EMISSION CONTROL SYSTEMS:**

ARGO warrants to the owner of any 2024 and subsequent model year ATV that the ATV is designed, built and equipped to conform at the time of sale with all applicable emission standards and is free from defects in materials and workmanship which would cause it to fail to conform with applicable requirements during the specified time and mileage limits.

A qualified repair shop or person of the owner's choosing may maintain, replace, or repair emission control devices and systems with original or equivalent replacement parts. However, warranty, recall and all other services paid for by ARGO must be performed at an authorized ARGO service center except for the emergency condition described below.

### **Your Warranty Rights and Obligations:**

In the United States and Canada, new ATVs must be designed, built and equipped to meet stringent Federal anti-smog standards. ARGO must warrant the emissions control system on your ATV for the periods of time listed below, provided there has been no abuse, neglect or improper maintenance of your ATV. Your emissions control system may include parts such as the sensors, the ignition and the engine computer. Also included may be hoses, connectors and other emissions-related assemblies. Where a warrantable condition exists, ARGO will repair your ATV at no cost to you, including diagnosis, parts, and labor.

### **Owner's Responsibility:**

As the ATV owner, you should also be aware that ARGO may deny you warranty coverage if your vehicle or a part has failed due to abuse, neglect, improper maintenance or unapproved modifications. If you have any questions regarding your warranty rights and responsibilities or if an authorized ARGO dealer cannot repair your ATV or honor your claim within a reasonable period of time, contact ARGO for assistance at 1-218-683- 5366. If you are not satisfied with the way in which a warranty claim is resolved by ARGO, you may write directly to:

Director, Gasoline Engine Compliance Center  
Compliance Division  
U.S. EPA  
2000 Traverwood Drive  
Ann Arbor, MI 48105

You must operate and maintain your ATV according to the requirements of the Owner's Manual including the maintenance schedule. This schedule is designed to keep your ATV emission control systems functioning properly and safely. You should keep receipts and records of maintenance and service but ARGO will not deny a warranty claim solely because of lack of maintenance records.

If an ARGO USA service center is not available within 100 miles, ARGO will reimburse you for those emergency repairs, including diagnosis, covered by the Emissions Warranties. Labor reimbursement is at a geographically-appropriate hourly labor rate for ARGO recommended time allowance. For reimbursement, present the replacement parts and a copy of the paid receipt to ARGO.

The use of replacement parts not equivalent to the original parts may impair the effectiveness of your ATV emissions control systems. If such a replacement part is used in the maintenance or repair of your ATV and an authorized ARGO dealer determines it is defective or caused a failure of a warranted part, your claim for repair to bring your ATV into compliance with applicable standards may be denied. If the part in question is not related to the reason your ATV fails to meet the standards, your claim will not be denied.



### **Emissions Warranty Coverage:**

This warranty begins on the date the ATV is delivered to the first purchaser, or the date it is first used as a demonstrator, lease, or company ATV, whichever comes first and continues for the time and mileage listed below:

Time: 30 months

Mileage 5,000 kilometers (3,100 miles) whichever comes first.

### **Warranted Parts:**

Fuel Tank  
Fuel Cap  
Fuel Line  
Fuel Line Fittings  
Clamps\*  
Carburetor  
Pressure Relief Valves\*  
Control Valves\*  
Control Solenoids\*  
Electronic Controls\*  
Control Cables\*  
Control Linkages\*  
Purge Valves  
Vapor Hoses  
Liquid/Vapor Separator  
Air Intake System  
Pressure Relief Fittings\*  
Vacuum Control Diaphragms\*  
Engine  
Engine Electronic Control Module\*  
Ignition System\*  
Sensors\*  
Exhaust System and Components  
Spark Arrestor  
Fuel Injection System and Components

\*Components that are part of the engine, fuel injection system, fuel evaporative system and emissions control system.

# Maintenance Record

MAINTENANCE INTERVAL	DATE OF SERVICE	MILEAGE	SERVICING DEALER NAME AND ADDRESS	REMARKS
1 Month				
3 Months				
6 Months				
12 Months				
18 Months				
24 Months				
30 Months				
36 Months				
42 Months				
48 Months				
54 Months				
60 Months				





# WARNING

Improper ATV use can result in SEVERE INJURY or DEATH.



**ALWAYS USE  
AN APPROVED  
HELMET AND  
PROTECTIVE  
GEAR**



**NEVER USE  
ON PUBLIC  
ROADS**



**NEVER CARRY  
MORE THAN  
ONE  
PASSENGER**



**NEVER USE  
WITH DRUGS  
OR ALCOHOL**

## **NEVER operate:**

- without proper training or instruction
- at speeds too fast for your skills or the conditions
- on public roads - a collision can occur with another vehicle
- with a passenger unless passenger seat is securely in place

## **ALWAYS:**

- use proper riding techniques to avoid vehicle overturns on hills and rough terrain and in turns
- avoid paved surfaces - pavement may seriously affect handling and control
- reduce speed and use extra caution at all times when carrying a passenger - dismount passenger when conditions require
- avoid paved surfaces - pavement may seriously affect handling and control

**LOCATE AND READ OPERATOR'S MANUAL.  
FOLLOW ALL INSTRUCTIONS AND WARNINGS.**