



2024 OPERATOR'S MANUAL



**Magnum XF 500
Magnum XF 500 LE**

*This vehicle is not a toy. Never allow anyone under
16 years of age to operate this OHRV.*

NOTE

Read this manual before you operate your ARGO Off-Highway Recreational Vehicle (OHRV). It contains safe operating instructions and warns the user about potential hazards that can result in personal injury.

Warnings are identified in the text by the following symbol:



WARNING

Warning text warns the user about potential hazards that can result in personal injury or death.

Cautions are identified in the text by the following symbol:



CAUTION

Caution text contains cautions that can prevent damage to the OHRV.

This manual is based on the latest product information available at the time of printing. ARGO reserves the right to make changes at any time and without obligation.

Reproduction of any part of this publication is prohibited without prior written permission.

© 2024 ARGO

FREE OHRV TRAINING

Free OHRV training is available for operators and passengers from Recreational Off-Highway Vehicle Association (ROHVA). ARGO recommends that you complete the training course before you first use your OHRV.

This on-line course takes approximately two hours to complete and presents you with a certificate of accomplishment as soon as you complete the course. The course does not have to be completed all at one time. It will remember where you left off in the training course and return to that point when you return.

Visit www.ROHVA.org to begin your training.



WARNING

CALIFORNIA PROPOSITION 65

WARNING: This product may contain fuels, oils and fluids, battery posts, terminals and related accessories which contain lead and lead compounds and other chemicals identified by the State of California to potentially cause cancer, birth defects, and other reproductive harm. These chemicals are found in vehicles, vehicle parts and accessories, both new and replacements. During maintenance, these vehicles generate used oil, waste fluids, grease, fumes and particulates, all identified by the State of California to potentially cause cancer, birth defects, and other reproductive harm.

For more information go to:

www.P65Warnings.ca.gov.

PREFACE

This manual describes the controls, operation and basic maintenance procedures for the ARGO OHRV from date of printing. Please take the time to read this manual carefully, for your safety and that of others. By following these instructions, you will ensure extended, trouble free operation of your OHRV.

Before you drive your ARGO OHRV, make sure you understand how to use all controls, particularly the brakes and steering system. Learn how to drive your OHRV in an open level area, away from buildings, trees and other obstacles, until you are completely familiar with its operating characteristics. Drive very slowly until your driving skills improve, and drive with caution and consideration at all times. The risk of accident or injury is greatest during the first weeks of use. Take special care during this period. ALWAYS RESPECT OUR ENVIRONMENT.

CAUTION TO THE ARGO OWNER/OPERATOR:

Before you operate your new OHRV, we highly recommend these important points:

- Read your Operator's Manual.
- Never allow anyone under 16 years of age to operate this vehicle.
- Take the training course before operating your OHRV, ask your dealer for more information.
- This vehicle is designed for two riders (one operator and one passenger).
- This Operator's Manual is provided to make the operator aware of proper operating procedures. It also includes useful information related to general care and maintenance of your vehicle.
- Prior to any OHRV operation, it is absolutely essential to read and comprehend each section in this manual as well as watch the safety video provided with your vehicle to develop an understanding of your vehicle and to ensure your safety. After reviewing this manual and watching the safety video, store them in a dry and easily accessible place for future reference.
- This manual is designed to help familiarize you with safety, assembly and operation. Read this manual and follow the recommendations to help ensure safe and efficient operation.
- The information contained within this manual was current at the time of printing. Constant improvement in the design and quality of components may result in discrepancies between the actual OHRV and information presented in this manual.
- To view the most up-to-date manuals or to order a replacement Operator's Manual, please contact an authorized dealer or visit the ARGO website.
- This manual has been prepared to instruct you in the safe and responsible operation of your OHRV. Read and abide by all safety alert information about this OHRV. If you do not understand any part of this manual, contact your local dealer for additional information and clarification. As the operator of this vehicle, you are in complete control. Only you can prevent an accident from happening.
- Right-hand and left-hand, as used in this manual, are determined when properly seated in the vehicle.
- Never modify the vehicle in any way that will alter the weight distribution of the vehicle, decrease its stability or increase the speed beyond the factory specifications. Such modifications can cause serious personal injury or death. The manufacturer prohibits and disclaims responsibility for any such modifications or any other alteration which would adversely affect the safety of the vehicle. The vehicle manufacturer reserves the right to incorporate engineering and design changes to products in this manual, without obligation to include these changes on units sold previously. The information contained in this manual may be revised periodically by the manufacturer, and therefore is subject to change without notice.

TABLE OF CONTENTS

SECTION 1 - Introduction

Introduction	1
Getting Acquainted With Your OHRV	4

SECTION 2 - Safety Information

Safety Information	7
Warnings	12
Hangtags and Warning Labels	19

SECTION 3 - Specifications

Specifications	21
----------------------	----

SECTION 4 - Description and Identification

Identification Number Records	23
Location of Parts and Controls	24
Control Functions	
Fuel Cap	26
Indicator Lights	26
Display Gauge Operation	27
Changing mode from MPH to Km/h.....	28
Changing ODO to Trip.....	28
Reset Trip Meter	28
Setting the Clock	29
Ignition Switch	29
Auxiliary Power Outlet	30
Seat Belt Lamp	30
EPS	30
Headlight Switch.....	31
Drive Select Switch.....	31
Tilt Steering Adjustment.....	32
Brake Pedal and Accelerator Pedal.....	32
Head Cushion Adjustment.....	32
Seat Removal and Installation.....	32
Seat Belts	33
Gear Selector	33
Cargo Box.....	33
Cargo Box Tailgate	34
Hood	34
Front Compartment	35
Rear Storage Compartment	35
Glove Box	35

SECTION 5 - Getting to Know Your OHRV

Getting to Know Your OHRV	37
Before Riding.....	37
Rider Preparation - Age Recommendation.....	37
Pre-Operation Checks	37
Safe Riding Rules.....	37
Protective Apparel	37

Accessories	38
No Modifications	38
For Off-Road Use Only	38
Environment	38
Weather	38
Terrain	38
Night Riding	39
Paved Surfaces	39
Trail Riding	39
Weight Limits	40
Load Capacity Rating	40
Trailer and Towing	41
Transporting	41

SECTION 6 - Before You Ride

Engine Break-In	43
Pre-Operation Checks	43
Pre-Operation Check Table	44
Seat Belts	44
Side Restraints	44
Rollover Protection Structure (ROPS)	44
Hydraulic Brakes	45
Fuel	45
Engine Coolant Reservoir	46
Coolant Level Inspection	46
Engine Oil	47
Oil Level Inspection	47
Front Differential / Rear Drive	48
Throttle Pedal	48
Fittings and Fasteners	48
Lights	48
Switches	48
Tires	49
How to Measure Tire Pressure	49
Tire Wear Limit	49

SECTION 7 - Operation

Seating	51
Starting the Engine	51
Warming up the Engine	52
Transmission Ranges	52
Braking / Stopping	53
Parking	53
Driving Downhill	53
Driving Uphill	54
Basic Turns	54
Crossing Obstacles	54
Crossing Water	55
Crossing Roads	55
Driving in Reverse	55

SECTION 8 - General Maintenance

General Maintenance	57
Maintenance Schedule	58
Radiator	59
Cooling System Inspection	59
Shock Absorbers	59
Cables	60
Engine Oil - Inspection	60
Engine Oil and Oil Filter Change	61
Front Gear Case Oil Inspection/Change	62
Rear Gear Case Oil Inspection/Change	62
Brake Hoses	63
Hydraulic Brakes	63
Brake Pads	64
Protective Rubber Boots	64
Ball Joint Boots	64
Tie Rod Boots	65
Drive Axle Boots	66
Wheel Removal	66
Wheel Installation	66
Battery	67
Battery Capacity	67
Charging / Maintenance Charging	69
Jump Starting	69
Spark Plug	70
Air Filter	70
Draining the V-Belt Cover	71
Tires	72
Tire Replacement	72
Muffler / Spark Arrester	72
Light Bulb Replacement	73
Headlight	73
Running Lights	74
Taillight/Brakelight	74
Checking / Adjusting Headlight Aim	75
Fuses	76
Noise Regulation	77
Troubleshooting	79

SECTION 9 - Preparation For Storage

Preparation For Storage	81
-------------------------------	----

SECTION 10 - Warranty

Limited Warranty	83
Emissions Warranty	85
Maintenance Record	87

NOTES

SECTION 1

Introduction

ARGO welcomes you to its growing family of new product owners. This Off-Highway Recreational Vehicle (OHRV) has been designed with care and built by skilled workers using quality materials.

Proper setup, maintenance and safe operating practices will help you get years of satisfactory use from this OHRV.

Your safety and the safety of all ARGO users is of the greatest concern to us. You will find numerous safety statements in this manual. Please read and follow them carefully. Always be safety conscious when you operate your ARGO and remember it is a motorized vehicle.

Please take the time to develop your driving skills before attempting new challenges. Observe the recommendations outlined in this Operator's Manual and remember; some things are just impossible, even with an ARGO.

WELCOME TO THE WORLD WIDE ARGO FAMILY!



Introduction

Thank you for choosing this quality ARGO OHRV. It has been designed and manufactured to provide you with reliable and enjoyable operation. This Owner's Manual should be considered a permanent part of your vehicle and must remain with the vehicle in the event of a resale.

This manual was prepared to provide you with the information required to operate and maintain your vehicle. This manual also covers rider-related instructions, as well as service and storage instructions. If your OHRV ever requires repair or service, contact an authorized ARGO dealer for professional service.

As the owner and rider of an ARGO OHRV, you should become thoroughly familiar with your vehicles basic operation, maintenance and storage procedures. Please read and understand the entire Owner's Manual before operating your ARGO OHRV to ensure safe and proper use. Always operate your OHRV within your level of skill and current terrain conditions.

At the time of publication, all of the information and illustrations in this manual are technically correct. Some illustrations herein are used to best represent a certain procedure or item and are not intended to depict actual conditions. Because ARGO is constantly refining and improving its products, there may be differences between the vehicle images and the text depicted in this manual and your OHRV. As such, no retroactive obligation to the product is available.

REPLACEMENT PARTS, ACCESSORIES and SERVICE

- Most replacement parts and accessories are typically available from your dealer. For immediate availability and convenience, it is recommended items be ordered from an authorized dealer. Take this manual and all supplements to the dealer when ordering parts in person.
- Orders may be subject to a minimum fee. A listing of authorized service providers in your area is also available on the website.
- Unapproved installation of parts or accessories can create a substantial safety hazard and increase the risk of personal injury.
- Use authorized parts only.

PLEASE TAKE A FEW MOMENTS TO GET ACQUAINTED WITH YOUR OHRV BY READING THIS OWNER'S MANUAL

NOTE:

The manufacturer DISCLAIMS LIABILITY FOR ERRORS IN THIS MANUAL, and SPECIFICALLY DISCLAIMS LIABILITY FOR INCIDENTAL AND CONSEQUENTIAL DAMAGES resulting from the use of the information and material in this manual.

Name: _____

Address: _____

Telephone: _____

Purchase Date (mm/dd/yyyy): _____

Model: _____

- Before operating this OHRV, the owner and each operator must understand that this vehicle was not designed or manufactured to meet specifications for use on public roads, streets, highways or thoroughfares.
- The owner and operator(s) must read and understand all the instructions for proper assembly and safe operation, as well as the instructions concerning the engine and all other portions of the OHRV, as described and illustrated in this manual.
- This vehicle is NOT to be operated by anyone under 16 years of age.
- This vehicle is NOT a toy.
- Be sure to follow the recommended maintenance schedule and service your OHRV accordingly.

PREVENTATIVE MAINTENANCE IS EXTREMELY IMPORTANT TO THE SAFE OPERATION AND LONGEVITY OF YOUR OHRV

We advise you to follow the recommended maintenance program as outlined in this manual. This program is designed to ensure all critical components on this OHRV are thoroughly inspected at specified intervals.

Precautionary Measures

Protect Your Sport

- Know all State and local laws relating to OHRV riding,
- Respect your OHRV
- Respect the environment, and
- You will gain the respect of other fellow riders.

GETTING ACQUAINTED WITH YOUR OHRV

This manual will provide you with a good basic understanding of the features and operation of this OHRV. This manual includes important safety information. It provides information about special techniques and skills necessary to ride the OHRV. It also includes basic maintenance and inspection procedures. If you have any questions regarding the operation or maintenance of your OHRV, please consult your dealer.

IMPORTANT SAFETY MESSAGE:

- The Consumer Product Safety Commission has concluded that OFF-HIGHWAY RECREATIONAL VEHICLES (OHRVs) may present a risk of DEATH or SEVERE INJURY in certain circumstances. While accidents may occur for many reasons:
 - As of September, 2022 the year 2019 is the most recent year of reporting for fatalities that CPSC considers complete. CPSC is aware of 537 people, including many children, have died in accidents associated with OHRVs during a 3-year period from 2017 through 2019.
 - Many people have become severely paralyzed or suffered severe internal injuries as a result of accidents associated with OHRVs.
 - Every month, thousands of people are treated in hospital emergency rooms for injuries received while riding an OHRV.
- **You should be aware that AN OHRV IS NOT A TOY AND CAN BE HAZARDOUS TO OPERATE.** An OHRV handles differently from other vehicles, including motorcycles and cars. A collision or rollover can occur quickly, even during routine maneuvers such as turning and driving on hills and over obstacles, if you fail to take proper precautions.
- Read this manual carefully and completely before operating your OHRV. Make sure you understand all instructions.
- Operation of this vehicle is restricted to those 16 years of age and older who possess a valid driver's license. Passengers must be able to keep their back against the seat back with feet flat on the floor while holding onto the handhold.
- Pay attention to the warning labels on the OHRV.
- Never operate an OHRV without proper training or instruction. For a training course, please consult a dealer or visit argoxtv.com for a link to RIDER SAFETY.
- This OHRV is designed for a two riders (one operator and one passenger).
- This OHRV is designed exclusively for off-road use. It is not designed, properly equipped or licensed to be safely operated on public streets and highways.
- This OHRV complies with all applicable off-road noise level and spark arrester laws and regulations in effect at the time of manufacture.
- Please check your local riding laws and regulations before operating this OHRV.
- For your safety, follow and understand all CAUTIONS, WARNINGS and LABELS contained in this Operator's Manual.
- For your safety, watch the safety video provided with your OHRV.
- Keep this Operator's Manual with your OHRV at all times for reference. FAILURE TO FOLLOW THE WARNINGS and CAUTIONS CONTAINED IN THIS MANUAL CAN RESULT IN SERIOUS INJURY OR DEATH.

IMPORTANT

Operate this OHRV with safety constantly in mind. Off-road vehicles face unpredictable and often hazardous terrain conditions. It is ultimately the operator's responsibility to handle the vehicle safely within its limitations and to decide when and where to travel.

FOR MORE INFORMATION ON OUR FULL PRODUCT OFFERING, VISIT OUR WEBSITE www.argoxtv.com

- For a detailed description of warranty coverage for your OHRV, refer to the Warranty section found in this Owner's Manual or visit our website.
- For a detailed description of the emissions warranty for your OHRV, refer to the Emissions Warranty section of this Owner's Manual or visit our website.

ARGO WANTS YOU TO BE SATISFIED WITH YOUR NEW OHRV. IF YOU DO NOT UNDERSTAND ANY PART OF THIS MANUAL OR ARE NOT SATISFIED WITH THE SERVICE RECEIVED, PLEASE TAKE THE FOLLOWING ACTIONS:

Discuss the matter with your dealership service manager. Make sure they are aware of any problems so they can assist you.



WARNING

All engine exhaust contains carbon monoxide, a deadly gas. Carbon Monoxide is a colorless, odorless, tasteless gas, which may be present even if you do not see or smell any engine exhaust.

Avoid Carbon Monoxide Poisoning.

- Do not run engine indoors. Even if you try to ventilate engine exhaust with fans or open windows and doors, carbon monoxide can rapidly reach dangerous levels.
- Do not run engine in poorly ventilated or partially enclosed areas such as barns, garages or carports.
- Do not run engine outdoors where engine exhaust can be drawn into a building through opening such as windows and doors.

NOTES

SECTION 2

Safety Information

An OHRV is NOT a Toy and Can Be Hazardous To Operate

An OHRV handles differently from other vehicles such as motorcycles and cars. A collision or rollover can occur quickly, even during routine operation such as turning, driving over obstacles, on hills or rough terrain, if you do not take necessary precautions.

SEVERE INJURY OR DEATH can result if you do not follow these instructions:

- Read this manual and all CAUTION/WARNING labels carefully and follow the operating procedures described.
- Never operate an OHRV without proper instruction. Take a training course. Beginners should receive training from a certified instructor.
- Never allow anyone under 16 years of age to operate this OHRV.
- Always wear the seat belt when operating or riding this OHRV.
- Never permit a guest to operate this OHRV unless the guest has read this manual and all product labels and has completed the training course.
- Never operate an OHRV on any paved surfaces, including sidewalks, driveways, parking lots, and streets.
- Never operate this OHRV on any public street, highway, or road (dirt or gravel).
- Never operate an OHRV without wearing an approved helmet that fits properly. You should also wear eye protection (goggles or face shield), gloves, boots, long-sleeved shirt or jacket, and long pants.
- Never consume alcohol or drugs before or while operating this OHRV.
- Never carry a passenger in the cargo box of this OHRV.
- Never operate this vehicle with the cargo box lifted or removed.
- Never operate this vehicle with the ROPS (Roll Over Protective Structure) removed. The ROPS provides as a structure to help limit intrusions by branches or other objects and may reduce the risk of injury in an accident.
- Always securely fasten the side restraints before operating the vehicle.
- Never put your hands or feet outside the vehicle for any reason while the vehicle is moving. Do not hold onto the ROPS or side restraint bar. If you think or feel the vehicle may tip, do not put your hands or feet outside the vehicle as they will not be able to prevent the vehicle from tipping. Any part of your body outside the vehicle can be injured by passing objects, the vehicle itself, or the ROPS.
- Never operate at excessive speeds. Always travel at a speed which is proper for the terrain, visibility and operating conditions, and your experience.
- Never attempt wheelies, jumps, or other stunts.
- Always inspect this OHRV each time you use it to make sure it is in safe operating condition. Always follow the inspection, maintenance procedures and schedules described in this manual.
- Always keep both hands on the steering wheel and both feet on the floor of the OHRV during operation.
- Always go slow and use caution when operating on unfamiliar terrain. Always be alert to changing terrain conditions when operating the OHRV.
- Never operate the OHRV on hills too steep for the abilities of the operator or the vehicle. Practice on smaller hills before attempting larger hills.
- Never operate on excessively rough, slippery, or loose terrain.
- Always follow proper procedures for turning as described in this manual. Practice turning at slow speeds before attempting to turn at faster speeds. Do not turn at excessive speed.

An OHRV is NOT a Toy and Can Be Hazardous To Operate

- Always have the OHRV inspected by an authorized ARGO dealer if it has been involved in any type of accident.
- **NEVER OPERATE UP OR DOWN HILLS STEEPER THAN 15 DEGREES.**
- Always follow proper procedures for climbing hills as described in this manual. Check the terrain carefully before you start up any hill. Never climb hills with slippery or loose surfaces. Never accelerate suddenly. Never go over the top of any hill at a high rate of speed.
- Always follow proper procedures for going down hills and for braking on hills as described in this manual. Check the terrain carefully before you start down any hill. Never go down a hill at a high rate of speed. Avoid going down a hill at an angle which would cause the OHRV to lean sharply to one side. Go straight down the hill whenever possible.
- Always follow proper procedures for crossing the side of a hill as described in this manual. Avoid hills with slippery or loose surfaces. Never attempt to turn the OHRV around on any hill until you have mastered the turning techniques described in this manual on level ground. Avoid crossing the side of a steep hill if possible.
- Always use proper procedures if you stall or roll backward when climbing a hill. To avoid stalling, maintain a steady speed when climbing a hill. If you stall or roll backwards, follow the special instructions for braking described in this manual.
- Always check for obstacles before operating in a new area.
- Never attempt to operate over large obstacles, such as large rocks or fallen trees. Always follow proper procedures when operating over obstacles as described in this manual.
- Always use caution when skidding or sliding. On slippery surfaces, such as ice, go slow and be very cautious in order to reduce the chance of skidding or sliding out of control.
- Never operate an OHRV in fast flowing water or in water deeper than the footrests.
Remember that wet brakes may have reduced stopping capability. Test your brakes after exiting any water. If necessary, apply the brake lightly several times to let friction dry out the pads.
- Always use the size and type of tires specified in this manual.
- Always maintain proper tire pressure as described in this manual.
- Never improperly install or improperly use accessories on your OHRV.
- Never exceed the stated load capacity for this OHRV.

An OHRV is NOT a Toy and Can Be Hazardous To Operate

IMPORTANT MESSAGE

Your safety is very important to ARGO. That is why we urge you to read this message before you operate this OHRV. Off-road riding can be fun. However, an OHRV is not a toy and it can be hazardous to operate. As with any activity involving speed and skill such as bicycling or skateboarding, poor judgment can result in injuries and we don't want that to happen! You can help prevent accidents by making good decisions about if, when, and how you ride this OHRV.

Evaluate Riding Readiness

The first decision you'll need to make is whether you're ready to ride. Riding readiness varies widely from one person to another, and while the minimum age for this OHRV is 16 years of age, there are other factors that you should consider.

Physical size and ability are important considerations. To help determine whether a rider is big enough for this OHRV, sit in the seat with back against the seat back, feet placed flat on the floor, hands on the steering wheel or handholds. If not, you are not physically ready to operate or ride this OHRV.

Also make sure you can comfortably reach and operate all the controls. For example, can you turn the steering wheel all the way to the right and left? Can you operate the throttle and brake controls while fully seated? If not, you are not physically ready to ride this OHRV.

Before you operate an OHRV, decide whether you are physically, mentally and emotionally ready to ride.

Patience And Practice

Even if you take a certified training course, it's up to you to ensure your safety. Remember, learning to ride an OHRV is a gradual step-by-step process. It takes time, patience and practice.

Personal Choices

A safe, enjoyable OHRV ride is dependent on many personal choices. An OHRV, like all motorized vehicles, can be dangerous to operate if you choose to ignore safety precautions, take unnecessary chances, or ride beyond your ability or your OHRV's capability. Don't allow the thrill of freedom or adventure to affect your ability to make good, safe choices.

An OHRV is NOT a Toy and Can Be Hazardous To Operate

Always Supervise Inexperienced Riders

Supervision is another important obligation of the owner. Even after riders become skilled off-road riders, it also helps to regularly remind all riders to follow the instructions and warnings in this manual. And remember, it's the owner's responsibility to see that the OHRV is properly maintained and kept in safe operating condition.

If you choose to lend your OHRV to another rider, make sure the rider is 16 years old or older and has completed the safety training course. You should understand that the decision to lend the OHRV is yours.

Use the below safety gear before operation:

Clothing and Gear

While riding your OHRV, you will find it important to dress correctly to prevent personal injury. Below is the minimum protection recommended to wear during every ride:

1. Helmet
2. Eye Protection
3. Long Pants
4. Long Sleeve Shirt
5. Gloves
6. Boots/Ankle Protection

Helmet

There are many different types and styles of helmet to choose from today. Be sure to choose a helmet that complies with the current standards of the U.S. Department of Transportation (DOT), The Snell Memorial Foundation, or the American National Standards Institute (ANSI). Helmets that comply with one or more of the above standards have a defined label located on the inside or outside of the helmet.

These helmets should provide full-face protection.

If you damage your helmet, obtain a new one immediately.

Remember: Your helmet is not providing any safety if the chin strap is not securely fastened.

Eye Protection

Wear eye protection, such as goggles, to completely surround your eyes to prevent any dirt or other items from getting into your eyes. Sunglasses are not a form of protection as they are open on the sides.

Long Pants and Long Sleeve Shirt

Protection from sticks, branches, long grass, airborne objects, or anything that could possibly scrape your skin. The heavier the material, the better the protection.

Gloves

Gloves will provide protection to your hands from any debris or inclement weather. Choose a glove that provides a gripping surface as well as protection.

An OHRV is NOT a Toy and Can Be Hazardous To Operate

Boots/Ankle Protection

Choose a boot that protects the largest possible of your leg (preferable up to your knee) and can handle impact of rocks, dirt or branches. Choose a boot that has low heel and a good tread will help prevent your feet from slipping off the controls in wet or rugged conditions.

First Aid and Survival

Prepare for the unexpected. Emergencies and accidents happen and are ever worse when you are not prepared for them. Below is a recommended list of items you should have before every ride:

1. Tools

Routine maintenance will generally eliminate the need for emergency repairs during your ride. Riding on rough terrain could cause some fasteners to loosen. Carrying the right tools can prevent down time. Below is a recommended list of tools to carry on your ride:

- a. Spark plug
- b. Spare parts
- c. Rope
- d. Tool kit
- e. Duct tape
- f. Headlight/Taillight bulbs

2. Water

Water is an important part of your ride regardless of the duration. Heat exhaustion and heat stroke can suddenly shorten your ride. If you become dehydrated, you may find yourself unable to safely operate your OHRV.

3. Identification

If something happens to you while operating your OHRV, emergency personnel will need to know who you are and who to call in the event of an emergency. It may be possible, you are unable to provide that information due to injury. Put identification in your pocket before you ride.

4. First Aid Kit/ Emergency Kit with Flashlight

Several items are recommended in your Emergency Kit including a *Flashlight*; *Matches* in the event you need to start a fire; *Flares* for signaling help; *First Aid Kit* to include bandages, tape, gauze, antiseptic spray, etc. if an injury should occur; *Money*.

5. Communication device - it may be necessary to make an urgent phone call.

6. Map/GPS

Warnings



WARNING

POTENTIAL HAZARD

Failure to follow the age recommendations for this OHRV.

WHAT CAN HAPPEN

Use of this vehicle by children can lead to serious injury or death. Children under the age of 16 may not have the skills, abilities, or judgment needed to operate this vehicle safely and may be involved in an accident causing serious injury or death..

HOW TO AVOID THE HAZARD

Never allow anyone under 16 years of age to operate this OHRV.



POTENTIAL HAZARD

Operating this vehicle without proper instruction.

WHAT CAN HAPPEN

The risk of an accident is greatly increased if the operator does not know how to operate this vehicle properly in different situations and on different types of terrain.

HOW TO AVOID THE HAZARD

All operators of this vehicle must read and understand this Operator's Manual and all warning, caution, and instruction labels prior to operating this vehicle.

POTENTIAL HAZARD

Operating this vehicle on paved surfaces.

WHAT CAN HAPPEN

The vehicle's tires are designed for off-road use only and are not for use on pavement. Paved surfaces may seriously affect the handling and control of the vehicle and may cause the vehicle to go out of control.

HOW TO AVOID THE HAZARD

Whenever possible, avoid operating the vehicle on any paved surfaces including streets, parking lots, sidewalks, and driveways. If operating on paved surfaces is unavoidable, travel slowly (less than 10 mph) and avoid sudden turns and stops.

POTENTIAL HAZARD

Allowing passengers to ride in the cargo box.

WHAT CAN HAPPEN

Serious injury or death. This vehicle is not designed to carry passengers in the cargo box. Passengers riding in the cargo box can be thrown from the vehicle during operation or if involved in an accident resulting in personal injury or death.

HOW TO AVOID THE HAZARD

Never permit passengers to ride in the cargo box. Do not install any seating in the cargo box.



WARNING

Indicates a potential hazard that could result in a serious injury or death.

Warnings

POTENTIAL HAZARD

Operating this vehicle on public streets, roads, or highways.

WHAT CAN HAPPEN

You can collide with another vehicle.

HOW TO AVOID THE HAZARD

Never operate this vehicle on any public street, road, or highway, even a dirt or gravel one. In many states it is illegal to operate an OHRV on public streets, roads, or highways. Always check state and local laws and regulations.

POTENTIAL HAZARD

Operating this vehicle after or while consuming drugs or alcohol.

WHAT CAN HAPPEN

Can seriously affect your judgment.
Can cause you to be slow to react.
Can affect your balance and perception.
Can result in an accident causing serious injury or death.

HOW TO AVOID THE HAZARD

Never consume drugs or alcohol before or while operating this vehicle.

POTENTIAL HAZARD

Failure to inspect the vehicle before operation.
Failure to properly maintain the vehicle.

WHAT CAN HAPPEN

Increases the possibility of an accident or equipment damage.

HOW TO AVOID THE HAZARD

Always inspect the vehicle every time you use it. Ensure it is in safe operating condition. Always follow the inspection and maintenance procedures and schedules described in this Operator's Manual.

POTENTIAL HAZARD

Operating this vehicle at excessive speeds.

WHAT CAN HAPPEN

Increases the chance of losing control of the vehicle, which can result in an accident.

HOW TO AVOID THE HAZARD

Always operate at a speed that is proper for the terrain, visibility, operating conditions, load, and your age and experience.

**Never Operate Up or Down Hills
Steeper than 15°**

15° MAX



WARNING

Indicates a potential hazard that could result in a serious injury or death.

Warnings

POTENTIAL HAZARD

Climbing hills improperly.

WHAT CAN HAPPEN

You may lose control, which could result in an accident.

HOW TO AVOID THE HAZARD

Always follow proper procedures for climbing hills.

Always check the terrain carefully before you start up any hill.

Never climb hills with slippery or loose surfaces.

Never accelerate suddenly or make sudden gear changes. The vehicle may flip over backwards.

Never go over the top of any hill at high speeds. An obstacle, sharp drop, or another vehicle or person may be on the other side.

POTENTIAL HAZARD

Operating or riding this vehicle without wearing an approved motorcycle helmet, eye protection, and protective clothing.

WHAT CAN HAPPEN

Operating without an approved helmet increases your chances of a severe head injury or death in the event of an accident.

Operating without eye protection can result in an accident and increases your chances of a severe injury in the event of an accident.

Operating without protective clothing increases your chances of severe injury in the event of an accident.

HOW TO AVOID THE HAZARD

Always wear an approved helmet that fits properly.

You should also wear:

Eye protection (goggles or face shield)

Gloves

Boots

Long sleeved shirt or jacket

Long pants

POTENTIAL HAZARD

Operating or riding in the vehicle without wearing a properly secured seat belt.

WHAT CAN HAPPEN

Serious injury or death. Occupants can be thrown in the passenger area of the vehicle, fall out of the vehicle during operation, or be seriously injured in the event of an accident.

HOW TO AVOID THE HAZARD

ALWAYS WEAR YOUR SEAT BELT and require passengers to wear their seat belt.

POTENTIAL HAZARD

Operating or riding in the vehicle without side restraints properly secured.

WHAT CAN HAPPEN

Serious injury or death. Occupants or their body parts can strike objects outside the vehicle, be crushed by the vehicle, or fall out of the vehicle during operation or in the event of an accident.

HOW TO AVOID THE HAZARD

Do not remove the side restraints. Ensure side restraints are secure before operating the vehicle. Stay seated with your seat belt fastened with your body completely inside the vehicle during operation.



WARNING

Indicates a potential hazard that could result in a serious injury or death.

Warnings

POTENTIAL HAZARD

Attempting abrupt maneuvers, sliding, skidding, fishtailing or donuts.

WHAT CAN HAPPEN

Increases the chance of losing control including rollover which can result in an accident.

HOW TO AVOID THE HAZARD

Never attempt abrupt maneuvers, sliding, skidding, fishtailing or donuts.
Don't try to show off.

POTENTIAL HAZARD

Failure to use caution when operating this vehicle on unfamiliar terrain.

WHAT CAN HAPPEN

You may encounter hidden rocks, bumps, or holes without enough time to react.
Could result in the vehicle going out of control causing an accident.

HOW TO AVOID THE HAZARD

Use caution when operating on unfamiliar terrain. Always be alert to changing terrain conditions.

POTENTIAL HAZARD

Failure to use caution when operating this vehicle on rough, slippery, or loose terrain.

WHAT CAN HAPPEN

You may lose traction or control, which could result in an accident.

HOW TO AVOID THE HAZARD

Do not operate this vehicle on rough, slippery, or loose terrain until you have learned and practiced the skills necessary to control this vehicle on such terrain.

POTENTIAL HAZARD

Operating on steep hills.

WHAT CAN HAPPEN

This vehicle can overturn more easily on steep hills than on level surfaces.

HOW TO AVOID THE HAZARD

Never operate this vehicle on hills too steep for the vehicle or for your abilities.
Practice on smaller hills before attempting larger hills.

POTENTIAL HAZARD

Going down a hill improperly.

WHAT CAN HAPPEN

You may lose control, which could cause the vehicle to overturn resulting in an accident.

HOW TO AVOID THE HAZARD

Always follow proper procedures for going down hills.
Always check the terrain carefully before you start down any hill.
Never go down a hill at high speeds.
Avoid going down a hill at an angle that would cause the vehicle to lean sharply to one side. Go straight down the hill where possible.



WARNING

Indicates a potential hazard that could result in a serious injury or death.

Warnings

POTENTIAL HAZARD

Stalling, rolling backwards, or improperly dismounting the vehicle while climbing a hill.

WHAT CAN HAPPEN

You may lose control, which could cause the vehicle to overturn resulting in an accident.

HOW TO AVOID THE HAZARD

Use proper gear and maintain steady speed when climbing a hill.

If you lose all forward momentum:

Apply the brakes. Place the transmission park ("P") after you have stopped.

If you begin rolling backwards:

Gradually apply the brakes while rolling backwards.

When fully stopped, place the transmission in park ("P").

POTENTIAL HAZARD

Failure to use caution in turns; turning too sharp or aggressive.

WHAT CAN HAPPEN

You may lose control, which could result in an accident.

HOW TO AVOID THE HAZARD

Always follow proper procedure for turning. Practice turning at slower speeds before attempting to turn at faster speeds. Do not attempt to turn at excessive speeds or too sharp for the conditions and for your experience level.

POTENTIAL HAZARD

Operating the vehicle with improper tires or improper or uneven tire pressure.

WHAT CAN HAPPEN

You may lose control, which could result in an accident.

HOW TO AVOID THE HAZARD

Always use the size and type of tires specified in this Operator's Manual.

Always maintain proper tire pressure.

POTENTIAL HAZARD

Operating the vehicle in deep or fast flowing water.

WHAT CAN HAPPEN

Tires may float, causing loss of traction and loss of control, which could result in an accident.

HOW TO AVOID THE HAZARD

Never operate the vehicle in fast flowing water or in water deeper than the floorboard.

Remember that wet brakes may have reduced stopping capability.

Test the brakes after exiting the water. If necessary, apply the brakes several times to dry out the brake pads.



WARNING

Indicates a potential hazard that could result in a serious injury or death.

Warnings

POTENTIAL HAZARD

Improperly operating over obstacles.

WHAT CAN HAPPEN

You may lose control, which could result in an accident.

HOW TO AVOID THE HAZARD

Before operating in a new area, check for any obstacles.

Never attempt to ride over large obstacles, such as fallen trees, stumps or large rocks.

Follow proper procedures outlined in this manual.

POTENTIAL HAZARD

Operating with the ROPS removed.

WHAT CAN HAPPEN

Could lead to serious injury or death.

HOW TO AVOID THE HAZARD

Never operate this vehicle with the ROPS removed.

POTENTIAL HAZARD

Overloading the vehicle or towing improperly.

WHAT CAN HAPPEN

You may lose control, which could result in an accident.

HOW TO AVOID THE HAZARD

Never exceed the stated load capacity for this vehicle.

Cargo should be distributed properly and secured.

Reduce speed when carrying cargo or pulling a trailer. Allow greater distance for braking.

Always follow proper procedures outlined in this manual.

POTENTIAL HAZARD

Operating this vehicle with improper modifications.

WHAT CAN HAPPEN

Improper installation and improper use of accessories or modification of the vehicle may cause changes in operation or handling which, in some situations, may lead to an accident.

HOW TO AVOID THE HAZARD

Never modify this vehicle through improper installation or improper use of accessories.

All parts and accessories added to this vehicle should be components designed for use on this vehicle and should be installed and used according to instructions.

If you have questions, please contact an authorized dealer.

POTENTIAL HAZARD

Failing to avoid pinch points when raising or lowering the cargo box.

WHAT CAN HAPPEN

Fingers, hands, or arms could be seriously injured when raising or lowering the cargo box.

HOW TO AVOID THE HAZARD

Avoid raising and lowering the cargo box until everything is clear of pinch points.



WARNING

Indicates a potential hazard that could result in a serious injury or death.

Warnings

POTENTIAL HAZARD

Starting or running engine in a closed area.

WHAT CAN HAPPEN

Exhaust fumes are poisonous and may cause loss of consciousness and death within a short period of time.

HOW TO AVOID THE HAZARD

Always operate your vehicle outdoors or in an area with adequate ventilation.

POTENTIAL HAZARD

Improper handling of gasoline.

WHAT CAN HAPPEN

Gasoline can ignite and you could be burned. Gasoline is poisonous and can cause serious injury.

HOW TO AVOID THE HAZARD

Always turn off the engine when refueling.

Do not refuel right after the engine has been running and is still very hot.

Do not spill gasoline on the engine or exhaust pipe/muffler when refueling.

Never refuel while smoking, or while in the vicinity of sparks, open flames, or other sources of ignition.

POTENTIAL HAZARD

Hot exhaust system.

WHAT CAN HAPPEN

Someone coming in contact with the exhaust system during or after operation could be burned.

HOW TO AVOID THE HAZARD

Do not touch the hot exhaust system.

Do not park the vehicle in a place where others might be likely to come in contact with the exhaust system.



WARNING

Indicates a potential hazard that could result in a serious injury or death.

Hangtags and Warning Labels

Your ARGO OHRV comes with various hangtags and several labels containing important safety information related to the vehicle. Anyone who operates the OHRV should read and understand the important safety information before operating.

The hangtags and labels are considered to be a permanent part of the OHRV. If a label becomes hard to read or comes off the vehicle, contact your ARGO dealer for a replacement.

WARNING

ROLLOVERS HAVE CAUSED SERIOUS INJURIES AND DEATH, EVEN ON FLAT TERRAIN AND OPEN AREAS.

NEVER operate at speeds too fast for conditions or outside your skill level.

NEVER operate on hills greater than 15 degrees.

FOLLOW ALL INSTRUCTIONS, CAUTIONS, and WARNINGS IN YOUR OPERATOR'S MANUAL. A REPLACEMENT OPERATOR'S MANUAL IS AVAILABLE UPON WRITTEN REQUEST.





WARNING

IMPROPER USE OF OFF-HIGHWAY VEHICLES CAN CAUSE SERIOUS INJURY OR DEATH.

DRIVE RESPONSIBLY

AVOID LOSS OF CONTROL AND ROLLOVER

- Avoid abrupt maneuvers, sliding sideways, skidding, or fishtailing.
- NEVER do stunts.
- Slow down before entering a turn.
- Avoid rapid acceleration when turning, even from a complete stop.
- Steer for hills, rough terrain, and other changes in traction and terrain. Avoid any gravel surfaces.
- Avoid riding slopes or side tilting.

RIDERS MUST PAY ATTENTION AND PLAN AHEAD.

IF YOU THINK OR FEEL THE VEHICLE MAY TIP OR ROLL OVER, REDUCE THE RISK OF INJURY:

- KEEP BOTH HANDS FIRMLY POSITIONED ON THE STEERING WHEEL OR HANDHOLDS AND BRACE YOURSELF.
- DO NOT PUT ANY PART OF YOUR BODY OUTSIDE THE VEHICLE FOR ANY REASON.

BE PREPARED - PLAN AHEAD

- Fasten seatbelts.
- Wear an approved helmet and protective gear.
- Ensure all side mirrors are fully latched.
- All riders must be able to sit with back squared to the seat-back, feet positioned flat on the floor, and both hands on the steering wheel at 9 o'clock.



WARNING

VEHICLE ROLLOVER COULD CAUSE SEVERE INJURY OR DEATH.

Keep all parts of your body inside the vehicle.

DO NOT remove this ROPS.

This structure complies with ISO 3471.

085-1521

WARNING



NEVER Carry more than one passenger in this vehicle.



WARNING

PROPER USE OF YOUR VEHICLE

DO YOUR PART TO PREVENT INJURIES:

- DO NOT ALLOW CARELESS OR RECKLESS OPERATION
- MAKE SURE ALL OPERATORS ARE 16 OR OLDER WITH A VALID DRIVERS LICENSE
- DO NOT ALLOW ANYONE TO OPERATE OR RIDE WHILE UNDER THE INFLUENCE OF DRUGS OR ALCOHOL
- DO NOT ALLOW OPERATION ON ANY PUBLIC ROADS (UNLESS DESIGNATED FOR OFF-HIGHWAY VEHICLE USE) AS COLLISIONS WITH OTHER VEHICLES CAN OCCUR
- DO NOT EXCEED MAXIMUM SEATING CAPACITY: 1 OPERATOR / 1 PASSENGER

UNDER 16



085-1521

Hangtags and Warning Labels

WARNING

DO NOT SIT ON OR USE TAILGATE AS A STEP



SEVERE INJURY OR DEATH can result if the following is ignored:

- NEVER exceed the vehicle load capacity including weight of operator, passenger, cargo, accessories, and trailer tongue. Maximum load in cargo box 441 lbs (200 kg)
- Reduce speed and allow extra room to stop when loaded or towing.
- Secure cargo in enclosed, a loose load can shift and unexpectedly change handling.
- Keep weight in cargo box centered, low and forward. Top-heavy loads increase the risk of an overturn.
- NEVER carry passengers in the cargo box.

580102

VEHICLE EMISSION CONTROL INFORMATION

EXCEEDING EMISSION LIMITS: Emissions may vary with engine speed, load, and operating conditions. Emissions may vary with engine speed, load, and operating conditions. Emissions may vary with engine speed, load, and operating conditions.

EXCEEDING EMISSION LIMITS: Emissions may vary with engine speed, load, and operating conditions. Emissions may vary with engine speed, load, and operating conditions. Emissions may vary with engine speed, load, and operating conditions.

EXCEEDING EMISSION LIMITS: Emissions may vary with engine speed, load, and operating conditions. Emissions may vary with engine speed, load, and operating conditions. Emissions may vary with engine speed, load, and operating conditions.



WARNING

Exceeding vehicle's towing load could cause an accident.

Reduce speed when towing a trailer.

Refer to Operator's Manual for details.

MAXIMUM TONGUE WEIGHT: 110 lbs (50 kg)

MAXIMUM TOWING CAPACITY: 1212 lbs (553 kg)

WARNING



- Keep hands, body and other bystanders away while closing cargo box.
- Do not operate the vehicle with the cargo box lifted.

WARNING



- Keep hands, body and other bystanders away while closing cargo box.
- Do not operate the vehicle with the cargo box lifted.



WARNING

- IMPROPER TIRE PRESSURE OR OVERLOADING MAY CAUSE LOSS OF CONTROL.
- LOSS OF CONTROL CAN RESULT IN SERIOUS INJURY OR DEATH.
- TIRE PRESSURE (COLD):
 - Front: 10 psi (70 kPa)
 - Rear: 14 psi (98 kPa)
- GROSS VEHICLE WEIGHT RATING: 2006 lbs (910 kg)
 - Maximum weight includes operator, passenger, cargo, and trailer tongue weight.

SECTION 3

Specifications

Specifications

ENGINE AND DRIVE	
Type	Four-Cycle SOHC
Bore x Stroke	89 x 71.2 mm (3.50 x 2.80 in.)
Displacement	443 cc
Cylinder Arrangement	Single
Compression Ratio	9.1:1
Starting System	Electric
Lubrication System	Wet sump
Ignition System	DC, ECU Automatic Control
Generator System	A.C. magneto
Battery Type	12V, 18AH MF-VTX20L
Spark Plug Type	NGK CR7E
Spark Plug Gap	0.028 - 0.032 in (0.7 - 0.8 mm)
Brake Type	Front: Dual disc Rear: Single disc
Air Filter	Foam (oiled)
Clutch Type	Wet, centrifugal automatic
Primary Reduction System	V-Belt
Secondary Reduction System	Shaft Drive
Transmission	CVT
Fuel Delivery	Electronic Fuel Injection (EFI)
CHASSIS	
Length (Overall)	106 in (269 cm)
Width (Overall)	56.69 in (144 cm)
Height (Overall)	72.84 in (185 cm)
Seat Height	32.91 in (83.6 cm)
Wheel base	72 in (182.9 cm)
Minimum Ground Clearance	10 in (25.4 cm)
Suspension	Front: 6.9 in (17.6 cm) Rear: 6.8 in (17.2 cm) Front / Rear: Dual A-arm
Tires	Size: Front - 25 x 8-12 Size: Rear - 25 x 10-12
Tire Pressure:	Front: 10.0 psi (68.9 kPa) Rear: 14.0 psi (96.5 kPa)

Specifications

MISCELLANEOUS	
Basic Weight (Approx. w/ fuel and oil)	Base Model: 1186 lb (538 kg) LE Model: 1278 lb (580 kg)
Cargo Box load (Max.)	441 lb (200 kg)
Fuel (Recommended)	87 Octane Regular Unleaded
Gas Tank Capacity (Rated)	8.5 U.S. Gal. (32.2 L)
Engine Oil (Recommended)	5W-30
Engine Oil Capacity	Rebuild: 3.02 qt (2.85 L) Change: 2.33 qt (2.20 L) Change w/filter: 2.54 qt (2.40 L)
Front / Rear Gear Case Oil (Recommended)	80W-90 Hypoid
Front Gear Case Capacity	Rebuild: 9.1 fl oz (270 ml) Change: 8.5 fl oz (250 ml)
Rear Gear Case Capacity	Rebuild: 8.5 fl oz (250 ml) Change: 7.78 fl oz (230 ml)
Headlight	12V / 35W / 35W x 2
Rear Light	12V / 21W / 5W x 2
Brake Light	12V / 5W x 2
Position Light	12V / 5W x 2
Specifications subject to change without notice.	

Description	Specifications	
	lb	kg
Vehicle Load Capacity	1152	522
Tongue Weight	110	50
Cargo Weight	440	200
Tongue Weight and Cargo Weight (maximum)	550	250
Towing Capacity	1212	550

Vehicle Load Capacity:

Total weight of operator, passenger, trailer tongue weight, accessories, cargo, and storage compartments.

Tongue Weight:

Downward force exerted on the hitch when the trailer is fully loaded at its normal towing height.

Accessory Weight Examples:

Winch, snow plow, gun scabbard, etc.

Tongue and Cargo Weight:

Total weight on trailer tongue and cargo box.

Towing Capacity:

Total weight of trailer and all cargo in/on the trailer.

SECTION 4

Description and Identification

Identification number records

Record the key identification number, frame serial number, engine serial number and model code information for assistance when order replacement parts.

KEY NO. _____

FRAME NO. _____

ENGINE NO. _____

MODEL CODE _____



Key identification number

The key identification number is stamped on each key. Use this number when ordering a replacement key.

Frame and Engine Serial Number

The frame serial number is stamped on the frame near the right front wheel.

The engine serial number is stamped on the left crankcase.

These numbers are required by the dealer to complete any Warranty process. No warranty will be allowed by ARGO if the VIN or ESN has been tampered with in any way.

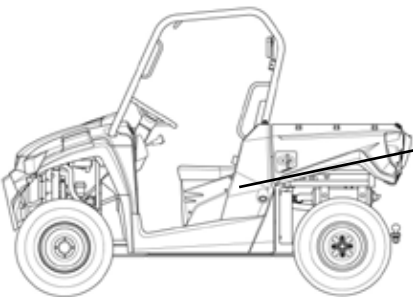
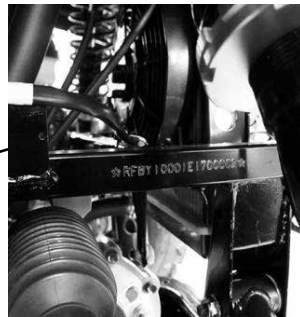
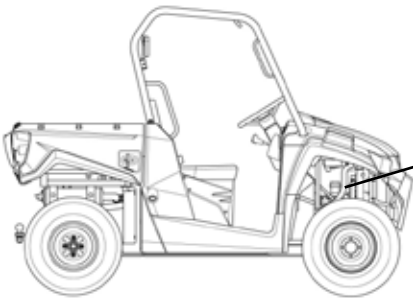

Location of Parts and Controls

Rear View

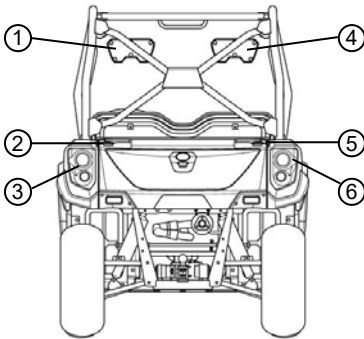

1. Left Head Cushion
2. Left Latch Handle
3. Left Tail / Brake / Back up Light
4. Right Head Cushion
5. Right Latch Handle
6. Right Tail / Brake / Back up Light

NOTE: The machine you have purchased may differ slightly from those shown in the illustrations of this manual.

Front/Side View

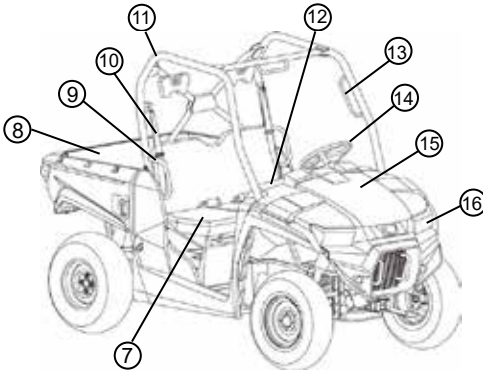

7. Seat
8. Cargo Box
9. Side Restraints
10. Seat Belts
11. Roll Over Protection System (ROPS)
12. Tool or Parts Box (under the seat)
13. Handholds
14. Steering Wheel
15. Battery (under the hood)
16. Headlights

Right Side View

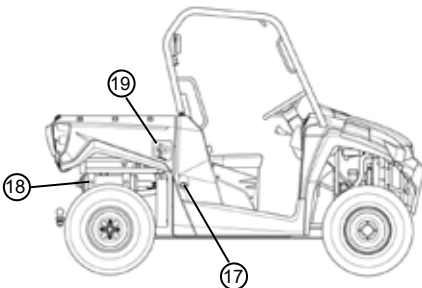

17. Fuel Fill Cap
18. Muffler and Spark Arrestor
19. Cargo Box Lever

Location of Parts and Controls

Operator View

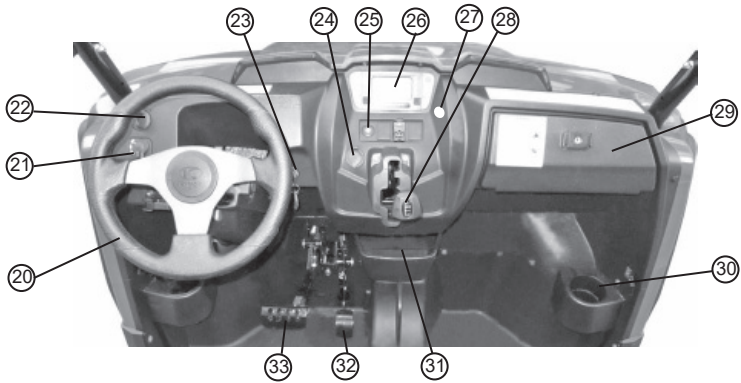

- 20. Steering Wheel
- 21. 2WD/4WD/Lock Switch
- 22. Light Switch
- 23. Ignition Switch
- 24. Auxiliary Outlet
- 25. Seat Belt Lamp
- 26. Speedometer

- 27. EPS Indicator Lamp
- 28. Gear Select Lever
- 29. Glove Compartment
- 30. Side Compartment
- 31. Center Compartment
- 32. Accelerator Pedal
- 33. Brake Pedal

Control Functions

Fuel Level Inspection/Refilling

Ensure the fuel level is sufficient. If the fuel level indicator is flashing “E”, refill as soon as possible.

1. Lift the cap tab and turn the tank cap counterclockwise to remove the cap.
2. Add gasoline.
3. Turn the fuel tank cap clockwise to tighten.

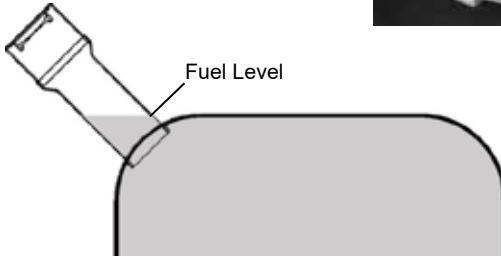

CAUTION

Be sure to stop the engine before refilling the fuel tank. Never fill the fuel tank near open flames or sparks. Do not overfill the fuel tank.

Indicator Lights

Indicator lights on the display gauge:

1. Low gear indicator
2. High gear indicator
3. Neutral gear indicator
4. Reverse gear indicator
5. Park indicator
6. High beam indicator light
7. Fuel injection system indicator light
8. Differential lock indicator light
9. Battery low voltage indicator light
10. High coolant temperature indicator light
11. Parking brake indicator light

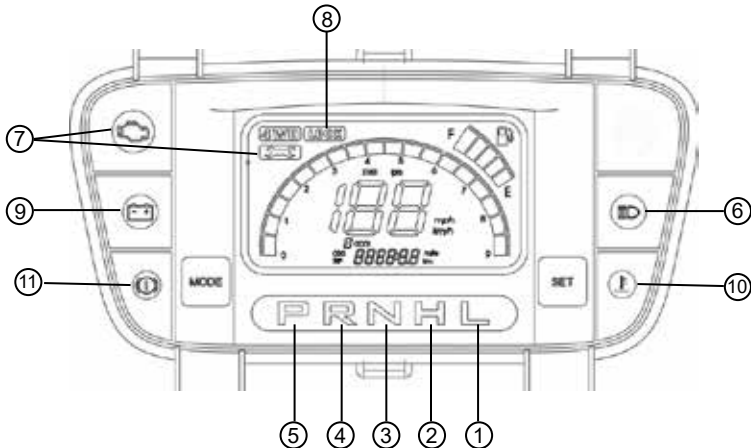

Control Functions

Instruments and Indicator Lights

Indicator lights on the display gauge:

- | | |
|---------------------|-------------------|
| 1. Odometer | 5. Tachometer |
| 2. Speedometer | 6. MPH / Km/h |
| 3. Four Wheel Drive | 7. Clock |
| 4. Fuel Gauge | 8. Adjust buttons |

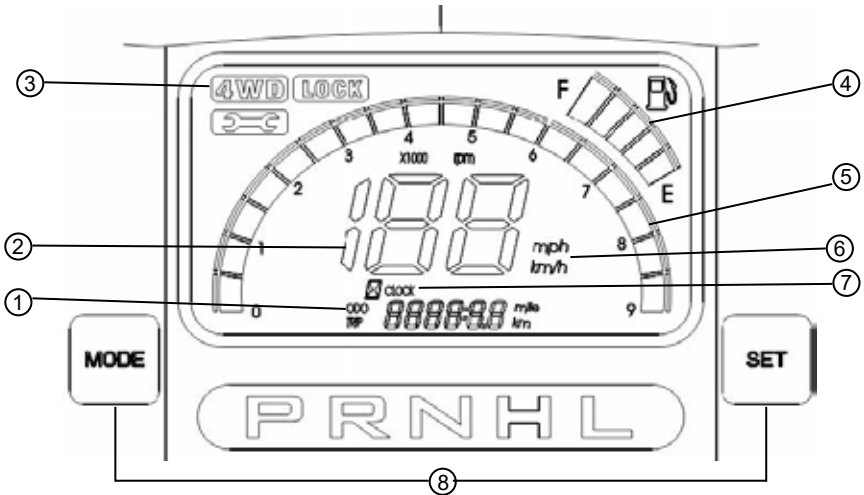

Operation Instructions for Display Gauge



Control Functions

Changing the mode from MPH or Km/h

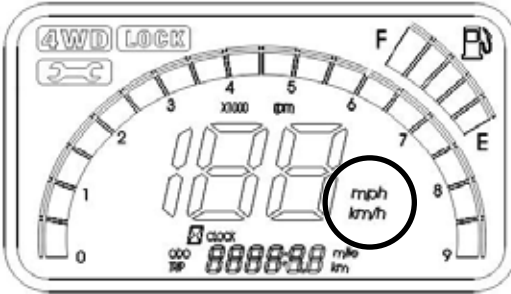

Press and hold Button A (MODE) for two seconds.

Changing ODO to Trip function

Press and hold Button B (SET) for two seconds.

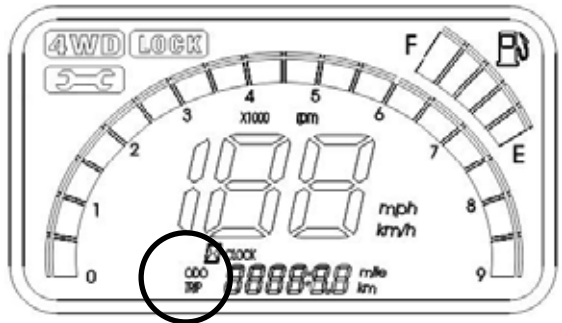

Reset "Trip Meter"

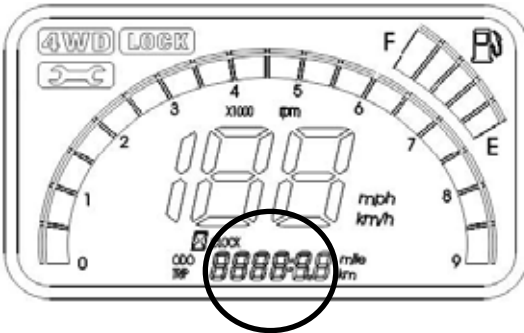

Press and hold Button A (MODE) and Button B (SET) simultaneously for two seconds.

Control Functions

Setting the Clock



Press and hold Button A (MODE) and Button B (SET) simultaneously for five seconds when set in the ODO mode. The clock will begin to flash.

When the clock is flashing, press Button B (Mode) to set the hour and Button A (Set) to adjust the minutes.

Wait for two seconds to finish setting the clock.

Ignition Switch

Functions of the respective switch positions are as follows:

“OFF” position:

All electrical circuits (except the accessory plug) are switched off. The engine will not start or run. The key can be removed in this position.

“ON” position:

The ignition circuit is complete and the engine can start and run. The key cannot be removed in this position.

“START” position:

The electrical starter is engaged by holding ignition key switch in this position. Upon release, the key will return to the “ON” position. The key cannot be removed in this position.



NOTE: The accessory plug is powered by the battery at all times.

NOTE: This vehicle has safety interlock switches installed to prevent the starter motor from activating when the transmission is not in the “N” (Neutral) or “P” (Park) position. Depress and hold the brake pedal to engage the starter when the transmission is not in neutral.



CAUTION

Always leave the ignition switch in the “OFF” position when the engine is not running. Leaving the ignition switch in the “ON” position when the engine is not running may cause the battery to discharge.

Control Functions

Auxiliary Power Outlet

The power outlet provides 12 volt DC power that may be used to power an auxiliary light or other optional 12 volt accessories.



CAUTION

Always use electrical accessories less than 180W.

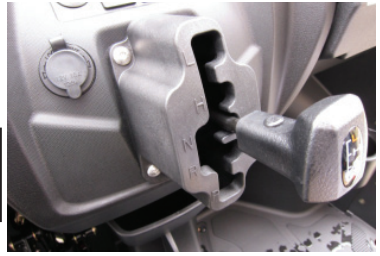

Seat Belt Lamp

The seat belt lamp will remain illuminated while the engine is running to alert you to fasten the seat belt. Once seat belt is fastened, the light will go out.

NOTE: This vehicle is equipped with a sensor for the driver's seat belt. If the driver's seat belt is not fastened, the vehicle speed is limited to 15 mph (24 km/h) and the seat belt indicator light will be illuminated. The seat belt indicator will remain illuminated until the driver's seat belt is fastened.



EPS (Electric Power Steering) Lamp

The EPS indicator lamp will illuminate if a power steering fault is detected. See your dealer if this lamp is illuminated or if you experience any steering issues.



Control Functions

Headlight Switch

The headlight switch has four position locations - Off, position light, low beam and high beam. The ignition switch key must be in the "ON" position. The lights will illuminate when turning the switch to the desired position.

1. **Lights off** - Lights are turned off in this position.
2. **Position light** - Running lights are illuminated in this position.
3. **Lo Beam Headlight** - Low beam headlight will illuminate in this position.
4. **Hi Beam Headlight** - High beam headlight will illuminate in this position. High beam indicator light will be illuminated on the gauge.

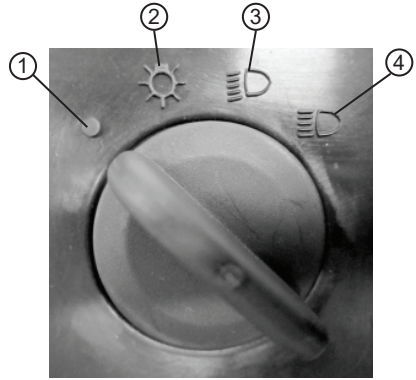

Drive Select Switch

The 2WD/4WD allows the operator to operate the vehicle in either two-wheel drive (rear wheel) or four wheel drive (all wheels).

For normal riding on flat, dry, hard surfaces, two-wheel drive should be sufficient.

In situations when additional traction is necessary, four-wheel drive would be the desired choice.

To select 2WD, rotate the switch to the 2WD position. To select 4WD, rotate the switch to the 4WD position. To engage the differential lock, rotate the switch to the 4WD LOCK position. Differential Lock indicator light will be illuminated on the gauge.



CAUTION

Do not attempt to either engage or disengage the differential while the vehicle is moving. Damage to the differential may occur if engaged while the vehicle is traveling at high speeds or while the rear wheels are spinning.



WARNING

NEVER EXCEED 10 MPH (16 KPH) WHEN DIFFERENTIAL IS LOCKED. LOSS OF CONTROL AT HIGH SPEEDS WHEN DIFFERENTIAL IS LOCKED MAY RESULT IN SEVERE INJURY OR DEATH.

Control Functions

Tilt Steering Adjustment

Pull the tilt steering adjuster to adjust the position of the steering wheel.



Brake Pedal and Accelerator Pedal

Depress the brake pedal to slow or stop the vehicle.

Depress the accelerator pedal slightly to increase engine speed. Always check the accelerator pedal in the original position before starting the engine. Ensure there is adequate accelerator pedal free play.

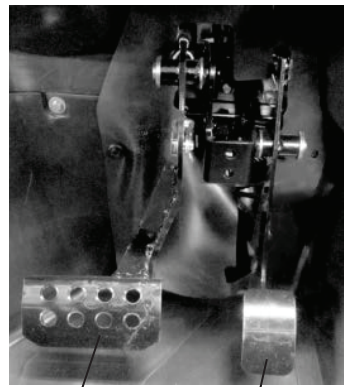

Brake Pedal

Accelerator Pedal

Head Cushion Adjustment

To adjust the head cushion height, remove the four bolts and adjust to the desired position. Tighten the bolts securely.



Seat Removal and Installation

1. Pull up on the front of the seat and push toward the front of the vehicle.
2. Install the seat by sliding the tabs into the rear of the seat base.
3. Push down firmly on the front of the seat until the pins are fully seated into the grommets.



Control Functions

Seat Belts

This vehicle is equipped with lap/shoulder seat belts for the operator and passenger. The seat belts must be fastened by both operator and passenger each time the OHRV is used.

1. To adjust the seat belt height, remove the nut and bolt securing the seat belt and adjust the bolt position to the desired height. Install the bolt and nut and tighten securely.

Three Positions



Gear Selector

To change gears, stop the vehicle and allow the engine to return to idle speed, then move the shift lever into the desired gear.

Do not attempt to shift gears with the engine speed above idle or while the vehicle is in motion.

Always place the transmission in park when the vehicle is left unattended.

Maintaining shift linkage adjustment is important to ensure proper transmission function. See your dealer if you experience any shifting issues.



Cargo Box

To Lift:

1. Push the cargo box release lever rearward, then slowly lift up on the cargo box until it stops in the "UP" position.

NOTE: There is a lever on both sides of the cargo box.

To Lower:

1. Lower the cargo box slowly to its original position and ensure the box is locked into the "DOWN" position.

Maximum load in the cargo box:

440 lbs (200 kg)



Control Functions

Cargo Box Tailgate

To Open:

1. Unlock the latches on the left and right sides of the cargo box, then lower the tailgate.

To Close:

1. Raise the cargo box tailgate to its original position and close and lock the latches on the left and right sides.



Tailgate latch



WARNING

DO NOT SIT ON OR USE THE TAILGATE AS A STEP.



WARNING

Never drive your OHRV with the tailgate in the open position or the cargo box in the lifted position. This may cause instability which could lead to an accident. Tilting the cargo box exposes the exhaust system. Always keep combustible materials away from the exhaust system. Exposure to the exhaust system's hot components may result in an accident.



Hood

To Open:

1. Pull "UP" on the front edge of the hood, then remove the hood.

To Install:

1. Insert the alignment tabs into the correct locations. Ensure hood is properly fitted.



WARNING

Ensure the hood is properly installed. If not properly installed, the hood may become loose and fall off and could cause a serious injury or accident.



Control Functions

Front Compartment

To Open:

1. Release the latches and open the front compartment.

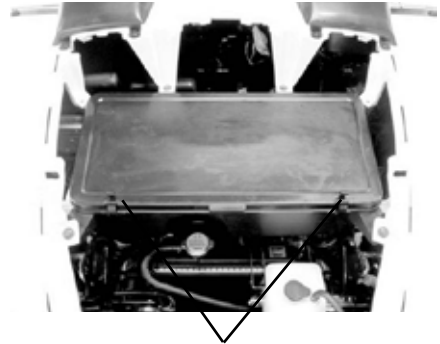

Latches

Rear Storage Compartment

To Open:

1. Pull "UP" on the handle to release the rear storage compartment.

To Close:

1. Pull "UP" on the handle to release the locking mechanism. Push in on the ends of the cover to ensure the latches engage with the grooves on the frame.

NOTE: If door is not properly closed, the latch may cause the rear compartment door to open.



Glove Box

To access the glove box compartment, pinch the locking tabs together and pull the lid downward (if unlocked) or insert the ignition key and rotate 1/8 turn counterclockwise and pull the lid downward. To lock the glove box compartment, close the lid, insert the ignition key and rotate 1/4 turn clockwise. Remove the key.



Control Functions

Tool Kit

The tool kit is located in the glove compartment. The tool kit provided with your SxS is sufficient to perform routine maintenance and simple repairs. Any extensive work requiring additional tools should be performed by your authorized ARGO dealer. It is recommended to put the tool kit in the vinyl bag and always carry them in the glove compartment.

1. Tool Bag
2. Air Pressure Gauge
3. 8/12; 10/14; 17/19 mm Wrenches
4. Screwdriver/Screwdriver Handle
5. Hexagon Wrenches
6. Spark Plug Wrench

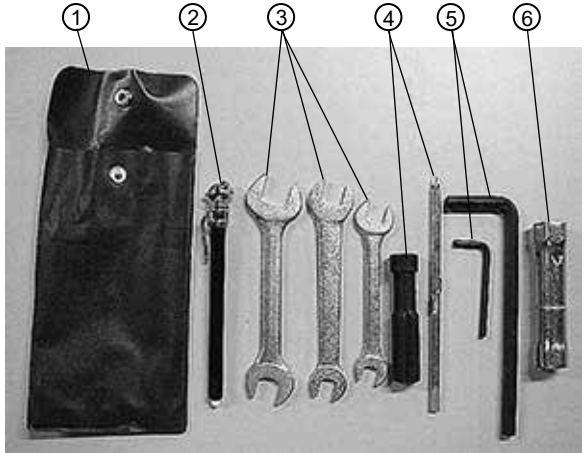

SECTION 5

Getting to Know Your OHRV

Getting To Know Your OHRV

This OHRV is for recreation use. This section, riding your OHRV, provides general OHRV riding instructions for recreational riding. The skills and techniques described in this section, however, are appropriate for all types of riding. Riding your OHRV requires special skills acquired through practice over a period of time. Take the time to learn the basic techniques well before attempting more difficult maneuvers.

Riding your new OHRV can be a very enjoyable activity, providing you with hours of pleasure. But it is essential to familiarize yourself with the operation of the OHRV to achieve the skill necessary to enjoy riding safely. Before you begin to ride, be sure you have read this Owner's Manual completely and understand the operation of the controls. Pay particular attention to the safety information and special safety messages. Please also read all caution and warning labels on your OHRV.

Before Riding

Before operating the OHRV, read and understand the "Important Message" section (beginning on page 7) carefully.

You need to prepare before riding. This includes getting proper instruction, making sure your vehicle is in good operating condition, and learning some basic safe-riding rules.

Rider Preparation - Age Recommendation

The minimum age for this OHRV model is 16. For safety, never let anyone under 16 years old operate this vehicle.

Pre-operation Checks

Always inspect your OHRV each time you use it to make sure the OHRV is in safe operating condition. Perform the pre-operation checks listed in this manual. Always follow the inspection and maintenance procedures and schedules described in the Owner's Manual.

Safe Riding Rules

Please note that the safe Riding Rules apply to all OHRV riders.

Even if you are an experienced rider, or after you become one, continue to follow these guidelines for your own safety and enjoyment.

Protective Apparel

Always wear an approved motorcycle helmet when riding your OHRV. You should also always wear goggles or a face shield, gloves, boots, a long-sleeved shirt or jacket, and long pants.

Getting To Know Your OHRV

Accessories

Genuine ARGO accessories have been specifically designed for and tested on this vehicle. Because ARGO cannot test all other accessories, you are personally responsible for properly selecting, installing, and using non- ARGO accessories.

1. Carefully inspect the accessory to make sure it does not block any lights, reduce ground clearance, or limit suspension travel, steering travel, or other controls.
2. Make sure the accessory does not interfere with your ability to shift body position on the seat or operate hand and foot controls.
3. Do not add electrical equipment that will exceed the vehicle's electrical system capacity. A failed fuse could cause a loss of lights or engine power.

No Modifications

Modifying this OHRV or removing original equipment may render the vehicle unsafe or illegal. Spark arresters and mufflers are required in most areas. Don't modify your exhaust system or emission control system components. Remember, excessive noise bothers everyone and creates a bad image for off-road vehicles.

For Off-Road Use Only

This OHRV is designed and manufactured for off-road use only.

Do not ride in areas posted "no-trespassing". Do not ride on private property without getting permission.

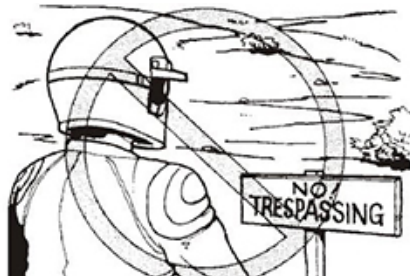

Environment

The environment that you will operate your OHRV in is often harsh and sometimes dangerous if you don't take proper precautions.

Weather

You need to consider the weather when you participate in an outdoor activity such as riding an OHRV. It is dangerous to ride your OHRV when the weather is bad or could potentially become bad. Before starting out on your OHRV, check the weather forecast for the location and duration of your ride.

Terrain

Always pay close attention to the terrain you're on, even if it is in an area familiar to you. Do not assume that the landscape you're used to doesn't change. Changes to landscape can happen at any time; fences can be constructed and excavations dug in a short period of time. Weather, climate, and development take their toll as well as erosion and other changes that can affect your OHRV's ability to ride smoothly and securely.

Because terrain can constantly change in configuration, you may not know how it has changed until you get there. Whether it's familiar or not, check out your surroundings before and during your ride.

Getting To Know Your OHRV

Night Riding

It is best to avoid riding your OHRV at night when visibility is limited. With little to no light, it is difficult to see what is around you.

If you must ride at night, proceed slowly and never ride at a speed that would prevent you from reacting to something that could come up in the limited view of your headlamps.

Paved Surfaces

Avoid riding your OHRV on paved surfaces. Your vehicle was not designed for use on pavement and its handling will become more difficult and unpredictable than when riding on non-paved surfaces.

Trail Riding

Use sound judgment when trail riding with your OHRV. You should only ride on trails that suit your riding ability.

Make yourself visible to others by using your OHRV's headlights and taillights. If you stop, pull completely off the trail in a way to protect yourself, your OHRV, and the environment.

Be aware of the rules and the laws that govern the area in which you will be riding your OHRV. Learn which trails you can legally and safely ride on and who else might be on those trails. Be aware of the signs posted in the areas you ride that would designate trail types and restrictions.

Getting To Know Your OHRV

Weight Limits

There are limits to how much weight can be carried on your OHRV. See Weight Limits section in the Specifications section. Modifying your OHRV, using non-standard equipment or riding on terrain that is not flat and smooth could further reduce these limits.

Never exceed the stated load capacities for this vehicle. Cargo should be properly distributed and securely attached. Reduce speed when carrying cargo or pulling a trailer and allow greater distance for braking.

Load Capacity Rating

This vehicle must always be loaded in accordance with the below Load Capacity Ratings chart.



WARNING

Overloading this vehicle could result in loss of control resulting in serious injury or death.

Description	Specifications	
	lb	kg
Vehicle Load Capacity	1152	522
Tongue Weight	110	50
Cargo Weight	440	200
Tongue Weight and Cargo Weight (maximum)	550	250
Towing Capacity	1212	550

Vehicle Load Capacity:

Total weight of operator, passenger, trailer tongue weight, accessories, cargo, and storage compartments.

Tongue Weight:

Downward force exerted on the hitch when the trailer is fully loaded at its normal towing height.

Accessory Weight Examples:

Winch, snow plow, gun scabbard, etc.

Tongue and Cargo Weight:

Total weight on trailer tongue and cargo box.

Towing Capacity:

Total weight of trailer and all cargo in/on the trailer.

Getting To Know Your OHRV

Trailer and Towing

This vehicle is equipped with a rear frame-mounted receiver for a standard 2 in (5.1 cm) receiver hitch (purchased separately).



WARNING

Ensure the load in/on the trailer is properly secured to prevent shifting while moving. **DO NOT OVERLOAD** the trailer.

Always maintain a slow speed when trailering and towing. Avoid sudden stops, sudden accelerations, or quick turns. Braking distances are affected when towing a trailer. When towing a trailer, always allow more stopping distance.



WARNING

Operating this vehicle without using extra caution when towing a trailer may be extremely dangerous. Trailer towing can affect the handling and braking of the vehicle. Tow only at low speeds and never exceed 10 mph. Avoid sudden stops and accelerations. Do not make sudden or quick turns. Avoid uneven surfaces and do not tow on a hill.

Transporting

When transporting this vehicle, follow the below procedure:

NOTE: The vehicle must be transported on all four wheels.

1. Place the transmission in park "P".



CAUTION

Failure to place the transmission in park "P" could allow the vehicle to roll off the trailer in the event of a strap failure.

2. Secure the vehicle to the deck/platform using proper load rated tie-down straps on the front and rear of the vehicle..



Hold Down Location - Left and Right Sides



CAUTION

Ensure side restraint buckles are securely fastened while transporting to prevent possible buckle damage to the vehicle.

NOTES

SECTION 6

Before You Ride

Engine Break-In

There is never a more important period in the life of your OHRV than the first 10 hours of operation. Always use a light throttle, keeping engine RPM well below the maximum. Varying the engine RPM during the break-in period allows the engine and transmission components to mate together so they will operate smoothly in the future. Applying some higher engine RPM and other loads during the break-in period is not detrimental when done in moderation. Do not pull a trailer or haul heavy cargo during the break-in period.

When the engine starts, allow it to warm up properly. Permit the engine to idle for several minutes until it has reached normal operating temperature. However, do not allow the engine to idle for excessively long periods of time, as this additional heat can affect future engine integrity.



CAUTION

BRAKE PADS MUST BE BURNISHED TO ACHIEVE FULL BRAKING EFFECTIVENESS.

Braking distance will be greater until the brake pads are properly burnished.

To properly burnish the brakes, use the following procedure:

1. Choose an area sufficient to safely accelerate to 30 mph and smoothly brake to a stop.
2. Accelerate to 30 mph, then compress the brake lever to decelerate to 0-5 mph.
3. Repeat procedure 10 times.
4. Stop the vehicle and allow the brake pads to cool to ambient temperature.



WARNING

Do not attempt sudden stops or put yourself into a situation with your OHRV where a sudden stop will be required until the brake pads are properly burnished.

After the completion of the break-in period, your OHRVs engine oil and filter should be changed. Other maintenance after break-in should include checking all prescribed adjustments and tightening all fasteners. It is your responsibility as the owner and/or rider of your vehicle to arrange for and pay for this initial service.

Because of the technical ability and resources available at an authorized ARGO dealer, it is best to take your vehicle to the dealer for service rather than attempting to perform this initial service yourself.

Pre-Operation Checks

Inspect your vehicle each time you use it to make sure the vehicle is in safe operating condition.

Always follow the inspection and maintenance procedures and schedules described in your Owner's Manual.



WARNING

Failure to inspect or maintain the vehicle properly increase the possibility of an accident or equipment damage. Do not operate the vehicle if you find any problem. If a problem cannot be corrected by the procedures provided in this manual, have the vehicle inspected by the dealer.

Operation - Before You Ride

Before operating this OHRV, check the following points:

ITEM	ROUTINE
Fuel	<ul style="list-style-type: none">• Check fuel level in fuel tank and add recommended fuel if necessary.• Check fuel line for leakage. Correct if necessary.
Engine Oil	<ul style="list-style-type: none">• Check oil level in engine and add recommended oil to specified level if necessary.• Check OHRV for oil leakage. Correct if necessary.
Differential/Rear Drive Gear Oil	<ul style="list-style-type: none">• Check OHRV for oil leakage. Correct if necessary.
Brakes	<ul style="list-style-type: none">• Lubricate cables if necessary.• Check operation, if soft or spongy, have the dealer bleed the hydraulic system.• Check brake pads for wear and replace if necessary.• Check brake fluid level in reservoir and add recommended brake fluid to specified level if necessary.• Check hydraulic system for leakage. Correct if necessary.
EFI System	<ul style="list-style-type: none">• Ensure Check Engine lamp is not illuminated. Correct if necessary.
Coolant	<ul style="list-style-type: none">• Check coolant level. Correct if necessary.
Wheels and Tires	<ul style="list-style-type: none">• Check wheel condition and replace if damaged.• Check tire condition and tread depth. Replace if necessary.• Check air pressure. Correct if necessary.
Chassis Fasteners	<ul style="list-style-type: none">• Ensure all nuts, bolts and screws are properly secured.
Instruments, Lights and Switches	<ul style="list-style-type: none">• Check operation and correct if necessary.

Seat Belts

Inspect the seat belts for any frayed, torn or damaged edges. Ensure the belts extend and retract smoothly and complete without binding or catching. Ensure the latch plate locks securely in place in the buckle and releases when the button is depressed.

Wash off any dirt and make sure the retractors are free of debris.

NOTE: Do not grease or oil the retractors.

Side Restraints

Inspect the operator and passenger side restraints for any frayed, torn or damaged edges. Ensure the latch straps lock securely in place in the receiver buckle on the front ROPS tube and releases when the button is depressed.

Wash off any dirt and make sure the latch straps are free of debris.

Rollover Protection Structure (ROPS)

Inspect the ROPS for any cracking, deformation, missing or damaged fasteners, loose fasteners, unauthorized repair or weldments or improper installation. If any of the above mentioned items are discovered, DO NOT OPERATE and immediately take the vehicle to an authorized ARGO dealer for service.

Operation - Before You Ride

Hydraulic Brakes

1. Foot Brake Pedal

Make sure there is no brake fluid leakage.

Check operation of the pedal. It should move smoothly and there should be a firm feeling when the brake is applied. If not, have the OHRV inspected by an authorized ARGO dealer.

2. Brake operation

Test the brakes at slow speed after starting out to make sure they are working properly. If the brakes do not provide proper braking performance, inspect the brakes for wear.



WARNING

POTENTIAL HAZARD

Riding with improperly operating brakes.

WHAT CAN HAPPEN

You could lose braking ability, which could lead to an accident.

HOW TO AVOID THE HAZARD

Always check the brakes at the start of every ride. Do not ride the OHRV if you find any problem with the brakes. If a problem cannot be corrected by the adjustment procedures provided in this manual, have the OHRV inspected by an authorized ARGO dealer.

Fuel

Fill the fuel tank when necessary and make sure there is sufficient gasoline in the tank.

Check for leaks.

Fuel level should be below the filler neck.

Recommended Fuel

87 minimum octane rating

Capacity:

8.5 gal (32.2 L)

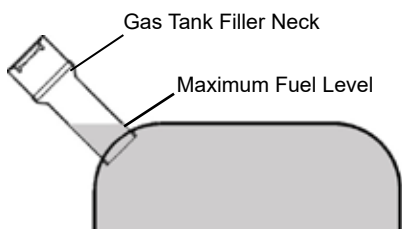

Your ARGO engine has been designed to use regular unleaded gasoline with a pump octane number of 87 or higher. In many areas, oxygenates (either ethanol or MTBE) are added to the gasoline. Oxygenated gasolines containing up to 10% ethanol, 5% methane, or MTBE are acceptable fuel. If knocking or pinging occurs, use a different brand of gasoline or premium unleaded fuel. Unleaded fuel will give you longer spark plug life and reduced maintenance cost.

Use unleaded fuel only because it produces fewer engine and spark plug deposits and extends the life of the exhaust system. Never use stale or contaminated gasoline or an oil/gasoline mixture. Avoid getting dirt, dust or water in the fuel tank.

Operation - Before You Ride



WARNING

Always fill the gas tank in a well-ventilated area. Never add gasoline to the gas tank near an open flame or with the engine running or hot. **DO NOT** smoke while filling the gas tank.

Do not overfill the gas tank. A fire hazard is possible. Always allow the engine to properly cool before filling the gas tank.



WARNING

POTENTIAL HAZARD

Improper care when refueling.

WHAT CAN HAPPEN

Fuel can spill, which can cause a fire and severe injury.

HOW TO AVOID THE HAZARD

Do not overfill the fuel tank. Be careful not to spill fuel, especially on the engine or exhaust pipe. Wipe up any spilled fuel immediately. Be sure the fuel tank cap is closed securely. Do not refuel immediately after the engine has been running and is still very hot.

Engine Coolant Reservoir

Coolant absorbs heat from the engine and transfers it to the air at the radiator. If the coolant level becomes low, the engine overheats and may suffer damage. Check the coolant level each day before operating the OHRV, and replenish coolant if the level is low. Change the coolant in accordance with the Maintenance Schedule.



Coolant Level Inspection

1. Position the OHRV on level ground.
2. Check the coolant level through the coolant level window on the reserve tank when the engine is cold as the coolant level will vary with the engine temperature. The coolant level should be between the "F" (Full) and "L" (low) marks.
3. If the coolant level is low, remove the cap from the reserve tank and add coolant or distilled water through the filler opening to the "F" (Full) mark. Install the cap.

NOTE: If water is added, have an authorized ARGO dealer check the antifreeze content of the coolant as soon as possible.

The radiator fan operation is completely automatic. It is switched on or off according to the coolant temperature in the radiator.



CAUTION

Hard water or salt water is harmful to the engine. You may use distilled water if soft water is not available.

Operation - Before You Ride

Engine Oil

Make sure the engine oil is at the specified level. Add oil as necessary. Check for any leaks.

Recommended engine oil

classification: API Service SJ type or higher. The recommended oil viscosity is SAE 5W-30. Ambient temperature should determine the correct weight of oil. See the viscosity chart or consult an authorized ARGO dealer for guidance.

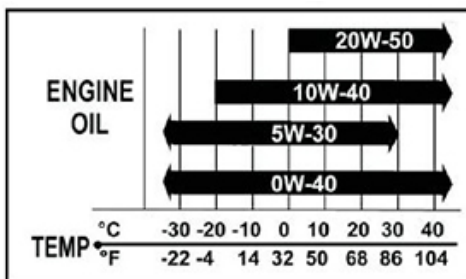

CAUTION

Be sure to use motor oils that do not contain anti-friction modifiers. Passenger car motor oils (often labeled “Energy Conserving”) contain anti-friction additives which will cause starter clutch slipping, resulting in reduced component life and poor engine performance.

Oil Level Inspection

There is an oil level stick (dip stick) on the left side of the engine for checking the engine oil level. To check the oil level follow the below procedure.

NOTE: The OHRV should be parked on level ground, with the engine key switch in the “OFF” position.

1. Unscrew the oil level stick, remove it and wipe it with a clean cloth.
2. Reinstall the oil level stick, thread it into the engine case.
3. Unscrew the oil level stick and visually note the oil level on the stick. The engine oil level should be above the “L” mark but not higher than the “F” mark. Add or remove oil as required.

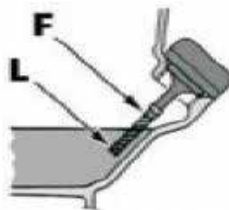

CAUTION

Do not overfill the engine with oil. Overfilling the engine can cause oil leaks and/or oil contamination of the air filter element. Always make sure the oil level is above the “L” mark but not higher than the “F” mark.

Operation - Before You Ride

Front Differential / Rear Drive

Recommended Lubricant: SAE 80W-90 Hypoid



CAUTION

Any lubricant used in place of the recommended lubricant may cause serious damage.

NOTE: The OHRV should be parked on level ground, with the engine key switch in the "OFF" position.

1. Remove the oil level check bolt (1).
2. Ensure oil level reaches the oil level check hole.
3. Inspect O-ring for damage. Replace if necessary.
4. Install the oil level check bolt. Tighten to 7.2 ft lb (10 N-m).

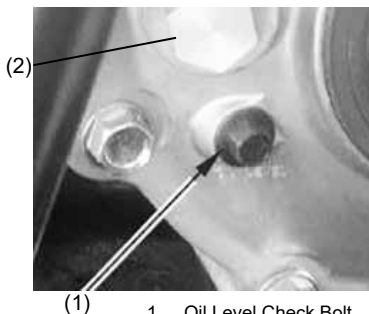

1. Oil Level Check Bolt
2. Oil Fill Bolt



CAUTION

Ensure no foreign material enters the gear case.

To add front gear case oil:

1. Remove the oil fill bolt (2).
2. Remove the oil level check bolt (1).
3. Ensure oil level reaches the oil level check hole.
4. Add appropriate type and amount of oil.
5. Inspect O-ring for damage. Replace if necessary.
6. Install the oil fill bolt and the oil level check bolt. Tighten oil fill bolt to 11 ft lb (15 N-m). Tighten the oil level check bolt to 7.2 ft lb (10 N-m).

Throttle Pedal

Check to see that the throttle pedal operates correctly. Throttle must open smoothly and spring back to the idle position when released. Adjust as necessary for proper operation.

Fittings and Fasteners

Always check chassis fittings and fasteners to ensure they are tight and secure. Take the vehicle to an authorized ARGO dealer or refer to the Service Manual for correct torque specifications.

Lights

Check the headlight, taillight and brakelight to ensure they are in proper operating condition. Repair as necessary for proper operation.

Switches

Check the operation of the headlight switch, and any other switches. Repair as necessary for proper operation.

Operation - Before You Ride

Tires

1. The tires listed below have been approved by ARGO for this model. Other tire combinations are not recommended.

How to Measure Tire Pressure

Use the low-pressure tire gauge found in the tool kit.

NOTE: The low-pressure tire gauge is included as standard equipment. Make two measurements of the tire pressure and use the second reading. Dust or dirt in the gauge could cause the first reading to be incorrect.



WARNING

POTENTIAL HAZARD

Operating this OHRV with improper tires, or with improper or uneven tire pressure.

WHAT CAN HAPPEN

Use of improper tires on this OHRV, or operation of this OHRV with improper or uneven tire pressure, may cause loss of control, increasing the risk of an accident.

HOW TO AVOID THE HAZARD

Follow the recommended tire pressures above.

Set tire pressure to the following (tires cold):

Recommended Tire Pressure:

Front - 10.0 psi (68.9 kPa)

Rear - 14.0 psi (96.5 kPa)



1. Low-pressure tire gauge

Tire Wear Limit

When the tire groove decreases to 1/8 in (3 mm) due to wear, replace the tire.

A. 1/8 in (3 mm)

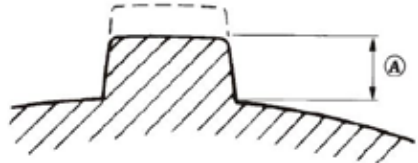

WARNING

POTENTIAL HAZARD

Operating this OHRV without being familiar with all controls and functions.

WHAT CAN HAPPEN

Loss of control, increasing the risk of an accident or injury.

HOW TO AVOID THE HAZARD

Read the Owner's Manual carefully. If there is a control or function you do not understand, contact an authorized ARGO dealer.

NOTES

SECTION 7

Operation

Always wear the following to reduce risk of injury in an accident:

- Approved motorcycle helmet that fits properly.
- Eye protection (goggles, helmet face shield or protective eyewear)
- Over the ankle boots, gloves, long sleeved shirt or jacket and long pants.

An approved helmet and other personal protective equipment can reduce the severity of injuries in an accident.



WARNING

Operating without an approved motorcycle helmet increases your chances of a severe head injury or death in the event of an accident.

Wear eye protection when operating your OHRV to reduce the risk of a serious accident or injury. Eye protection such as a face shield or goggles may reduce the risk of foreign material getting in your eyes and help prevent loss of vision.



WARNING

Operating without eye protection can result in an accident and increases your chances of a severe injury in the event of an accident.

Seating

1. Position yourself into the vehicle and sit down.
2. Fasten seat belt (both operator and passenger).
3. Ensure side restraints are secured in place.



WARNING

Ensure operator and passenger seat belts are properly fastened and secure before operating or riding in this vehicle. Falling from a moving vehicle could result in serious injury or death.

Starting the Engine

Always start the engine with the vehicle on a flat, level surface. Always start your vehicle outside as it produces carbon monoxide poisoning which will cause harm.

NOTE: This vehicle is equipped with a sensor for the driver's seat belt. If the driver's seat belt is not fastened, the vehicle speed is limited to 15 mph (24 km/h) and the seat belt indicator light will be illuminated. The seat belt indicator will remain illuminated until the driver's seat belt is fastened.

Follow these steps to start your vehicle:

1. Place the gear selector in the "P" park position.
2. Depress the brake pedal.
3. Rotate the ignition switch key to the "START" position. When the engine starts, release the key to the "RUN" position. Do not increase engine RPM above idle.

NOTE: The engine can be started in any gear if the brake pedal is applied. However, it is recommended to shift into "N" (Neutral) or "P" (Park) before starting the engine. If either indicator light fails to illuminate when the gear select lever is in the neutral or park position, have an ARGO dealer inspect the electrical circuit.

Operation



CAUTION

Do not run the starter motor for more than 5 (five) seconds per starting attempt as the starter motor may overheat causing severe damage. Allow 10 (ten) seconds between starting attempts to allow the starter motor to cool. Pay attention not to discharge the battery.

NOTE: If the battery voltage is low, engine cannot be started. Properly charge the battery.

4. Do not depress the throttle pedal until the engine has reached operating temperature.
5. Allow the engine to properly warm up. If the engine has not reached proper operating temperature, the spark plug may not have reached a high enough temperature to burn off the excess fuel in the combustion chamber.

Warming Up Engine

To get maximum engine life, always warm up the engine. Never accelerate hard with a cold engine!



CAUTION

- Do not operate the throttle (open and close rapidly) as the vehicle may move forward suddenly, causing possible loss of control.
- Do not leave the vehicle unattended while the engine is warming up.

Transmission Ranges

This OHRV is equipped with an automatic, dual-range transmission with reverse capability. To shift your OHRV into the different drive ranges, follow the below steps.

To properly change transmission range:

1. Apply brake.
2. Move shift lever to the desired range.
3. Release brake.

NOTE: The **HIGH** range is for normal riding conditions with light loads. The **LOW** range is for carrying heavy loads, slow speeds or trailer towing. **LOW** range position provides slower speed and greater torque to the wheels.



CAUTION

Always shift the transmission into **LOW** range when operating on wet or uneven terrain, when towing or pushing heavy loads, or when using a plow. Failure to follow this caution may result in premature V-belt failure or other damage to the drive system.

Operation



CAUTION

Never shift the transmission while your OHRV is in motion. Should your vehicle be on a surface that is not level, depress the foot brake pedal before shifting into another gear or into reverse.

Braking / Stopping

Always allow plenty of room and time to stop your OHRV safely. Be alert and prepared, as sometimes quick stops are inevitable. Whether you are stopping slowly or stopping quickly, follow these braking guidelines:

1. Release the throttle pedal; then apply pressure on the foot brake pedal.
2. If your wheels lock, release the brake, then apply the brakes again.
3. Avoid prolonged application of the brakes. Even maintaining minimal pressure on the brake pedal will cause the brake pads to drag on the brake rotor and may cause overheating of the brake fluid.



WARNING

Use only ARGO approved brake fluid. Never substitute or mix different types or grades of brake fluid, as unexpected loss of braking ability can result. Check the OHRVs brake fluid level and pad wear before each use. The loss of braking ability can result in severe injury or even death.



WARNING

Prolonged and repetitive use of the vehicles hydraulic brake for high speed stops will cause overheating of the brake fluid and premature brake pad wear which can cause unexpected loss of braking ability. Premature brake failure may occur.

Parking

Parking requires following the previous rules of braking; then:

1. When the vehicle comes to a complete stop, shift into the park "P" position.
2. Turn the ignition switch to the "OFF" position.
3. Always try to park your vehicle on level ground. If you have to park on a hill, block the wheels on the downhill side.

Driving Downhill

1. Keep both hands on the steering wheel.
2. Avoid steep hills.
3. Before driving down the hill, shift into low gear and release the accelerator to allow for maximum engine braking. Do not use 4-wheel drive when driving down a hill. Engine braking can cause the front wheels to slide reducing steering control.

Operation

Driving Uphill

Whenever driving uphill, follow these precautions:

1. Avoid steep hills (15° maximum).
2. Always travel straight uphill.
3. Keep both hands on the steering wheel and both feet on the floor.
4. Proceed at a steady rate of speed and throttle opening.

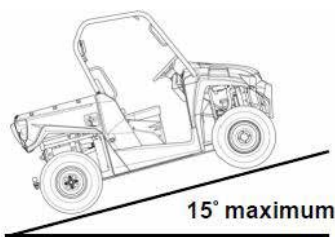

NEVER OPERATE UP OR DOWN HILLS GREATER THAN 15°.

Basic Turns

Steering effort is at its lowest when the vehicle is in two wheel drive (2WD). Greater effort is required when the vehicle is in four wheel drive (4WD). The greatest effort is required if the vehicle is in 4WD and the differential (if equipped) is locked.

Slow down before approaching a turn. The basic turn maneuver is to drive at a low speed and gradually adjust the steering needed to suit the driving surface. Do not make sudden, sharp turns on any surface.

If the vehicle begins to skid sideways during a turn, steer in the direction of the skid. Also, avoid hard braking or acceleration until you have regained control.



WARNING

Use extreme care while turning - turning the steering wheel too far or too fast can result in loss of control or a rollover. Excessive speed, driving aggressively, or making quick turns can cause loss of control, tipping, or rollover even on flat surfaces. Uneven terrain, rough terrain, soft or slippery surfaces, and paved surfaces can also cause a loss of control in a turn. On loose or soft surfaces, allow more time and distance to turn and slow down.

Crossing Obstacles

Crossing obstacles can be hazardous. There is always potential of the vehicle tipping or rolling over. If you cannot go around an obstacle, follow these procedures:

1. Stop the vehicle and place the transmission in park "P". Get out of the vehicle and inspect the obstacle from both sides. If you are confident you can cross the obstacle safely, select four wheel drive (4WD) and proceed with caution.
2. Approach the obstacle as close as possible to 90° to minimize tipping..
3. Keep vehicle speed slow enough to maintain control but fast enough to maintain forward momentum.
4. Use only enough power and speed to cross the obstacle safely while allowing time to react to any possible changes or conditions.

Operation

Crossing Water

This vehicle can operate in water up to the floorboard. Stay away from fast flowing rivers. In deep water, the vehicle's tires can be buoyant and may lose traction due to floating.

1. Before entering any water, physically check the depth and current of the water, especially if you can not see the bottom. Also check for any potential hidden obstacles.
2. Keep a slow and steady speed while maintaining momentum.
3. Ensure you have a way out on the other side of the water.
4. Once you have driven in any water, briefly apply the brakes to dry the pads.



WARNING

Do not operate this vehicle on frozen bodies of water unless you have first verified the ice thickness will sufficiently support the vehicle, cargo, and passenger. The vehicle could break through the ice causing serious injury or death.

Crossing Roads

It may become necessary to cross a road or highway. If so, follow these guidelines:

1. Come to a complete stop on the shoulder of the road.
2. Check both directions for oncoming traffic.
3. Crossing near a blind corner or intersection is very dangerous; avoid crossing near a blind corner.
4. When clear, proceed straight across to the opposite shoulder..
5. Allow extra time to cross the roadway.
6. It is illegal to cross public roads in some places. Know your state and local laws.

Driving in Reverse

While operating in reverse, follow these guidelines:

1. Back slowly.
2. Apply the brakes lightly to stop.
3. Avoid turning at sharp angles.
4. Always avoid backing down a hill.
5. Never accelerate quickly while backing up.
6. Always inspect left and right sides before backing up.

NOTES

SECTION 8

General Maintenance

NOTE: Proper maintenance of the OHRV is extremely important for the safe operation and optimum performance. Follow the Maintenance Schedule and all ensuing maintenance instructions/information.

Inspection, adjustment and lubrication will keep your vehicle in the safest and most efficient condition possible.

Safety is an obligation of the vehicle owner/operator.



WARNING

Failure to properly maintain the vehicle may increase your risk of injury or death during service or while using the vehicle. If you are not familiar with vehicle service, have a dealer perform the service.



WARNING

Turn off the engine when performing maintenance unless otherwise specified.

- A running engine has moving parts that can catch on body parts or clothing and electrical parts that can cause shocks or fires.
- Running the engine while servicing can lead to eye injury, burns, fire or carbon monoxide poisoning or death.



WARNING

Brake discs, calipers, drums and linings can become very hot during use. To avoid possible burns, let brake components cool before touching them.

The intervals given in the scheduled maintenance charts should apply to normal riding conditions. However, **depending on the weather, terrain, geographical location and individual use, the maintenance intervals may need to be shortened.**

You may choose any qualified repair shop or person to maintain, replace, or repair emission control devices and systems with original or equivalent replacement parts. However, warranty, recall and all other services paid for by ARGO must be performed at an authorized ARGO service center which will complete repairs in a reasonable amount of time. ARGO service centers can provide all manners of service.

Ensure the service book is stamped and signed. Failure to do so could invalidate your warranty.

The maintenance schedule is based on months of use or kilometers/miles traveled, whichever comes first.

Maintenance Schedule			
Item	Initial 100 miles/150 Km 1 month	Every 600 miles/1000 Km 6 months	Every 1200 miles/2000 Km 12 months
Engine oil	R	R	R
*Oil strainer	C,R	C,R	C,R
Engine oil filter	R	R	R
Final gear oil	I		I,R
Differential gear oil	I		I,R
Air filter element (for engine and *V-belt compartment)	I,E	I,R	I,R
*Throttle body			I,C
*Cylinder head cover breather system		I,R	I,R
Spark plug	I,C,R	I,C,R	I,C,R
*Fuel line		I,R	I,R
*Valve adjustment	I	I	I
*Brake	I,R	I,R	I,R
*Coolant	I,R	I,R	I,R
*V-belt	I,R		I,R
*Exhaust system		I,T,R	I,T,R
Spark arrester		I	I
Tires/*Wheels	I,R	I,R	I,R
*Wheel bearings	I,R	I,R	I,R
*Steering system	I,R	I,R	I,R
*Drive shaft boots		I,R	I,R
*Suspension		I	I
Throttle cable, brake lever pivot points, knuckle shaft, steering shaft		L	L
*Fittings, fasteners and nuts	I	I	I
Lug nuts	T	T	T

I = Inspect, clean, adjust, lubricate, replace as necessary

C = Clean

L = Lubricate

R = Replace

T = Tighten

E = Extreme Conditions

***** = Dealer Maintenance

General Maintenance

Radiator

The radiator area requires to be checked periodically for debris. Inspect the radiator fins, they must be clean, free of mud, dirt, leaves and any other debris that would prevent the radiator to cool properly. Remove as much of the debris as possible with your hands. If water is available, use a low pressure to rinse the radiating fins. Do not use high pressure as it will damage the radiator.



CAUTION

Never clean radiator with your hands when engine is hot. Let the radiator cool down before cleaning.

Do not use high pressure water to clean radiator, damage may occur.



CAUTION

Continued operation of the vehicle with high engine temperature may result in premature engine damage.

Cooling System Inspection

1. Remove the hood.
2. Check the coolant level in the coolant reservoir when the engine is cold as the coolant level will vary with engine temperature. The coolant level should be between the "FULL" and "LOW" marks on the reservoir.
3. If the coolant level is low, remove the coolant reservoir cap, and add coolant or distilled water to raise it to the specified level.



Recommended Coolant Solution: Water: 50% - Antifreeze: 50% (1:1)

NOTE: A permanent type of antifreeze is installed in the cooling system when shipped. It is green colored and contains ethylene glycol. It is mixed at 50% with water and has a freezing point of -31° F (-35° C).



CAUTION

Hard water or salt water is harmful to the engine. You may use distilled water if soft water is not available.

Shock Absorbers

Each shock absorber on your vehicle should be visibly inspected weekly for excessive fluid leakage (some seal leakage is normal), cracks or breaks in the shock body, or a bent shock rod. If any of these conditions are present, replacement is necessary.

NOTE: If you ride your vehicle in extremely cold weather (-10° F/-23° C or colder), a small amount of fluid leakage may occur on the shock rod. Unless the leakage is excessive, replacement of the shock absorbers is not necessary.

General Maintenance

The shock absorbers have spring force adjustment sleeves with five positions to allow the spring rate to be adjusted for different riding conditions. If the spring rate is too soft or too stiff, adjust the sleeve according to the chart below.



NOTE: Properly lift the vehicle off the ground to remove load on suspension before adjusting shock springs. Use a spanner wrench to adjust the spring force adjustment sleeve to the desired position.

Position	Spring Force	Setting	Load
1	↓ Stronger	Soft	Light
2		↕ Stiff	↕ Heavy
3			
4			
5			

General Lubrication

Cables

Under normal use, the cables do not require lubrication. However, it is advisable to lubricate the ends of the cables periodically with a quality cable lubricant.

Engine Oil Level Inspection

NOTE: The vehicle should be parked on level ground, with the engine key switch in the "OFF" position.

1. Remove the oil level stick and wipe it off with a clean cloth.
2. Insert the oil level stick into the filler hole and screw it in.
3. Remove the oil level stick and inspect the oil level.
4. The oil level should be between the minimum and maximum marks. If the level is low, add oil to the proper level.
5. Reinstall oil level stick and tighten securely.

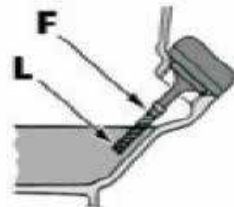

CAUTION

Do not overfill the engine with oil. Overfilling the engine can cause oil leaks and/or oil contamination of the air filter element. Always make sure the oil level is above the "L" mark but not higher than the "F" mark.

General Maintenance

Engine Oil and Oil Filter Change

NOTE: The vehicle should be parked on level ground, with the engine key switch in the “OFF” position.

Change the engine oil and oil filter at the scheduled intervals. The engine should always be warm when the oil is changed so the oil will drain easily and completely.

1. Park the vehicle on level ground.
2. Warm up the engine for several minutes and stop the engine.
3. Place a suitable drain pan under the vehicle.
4. Remove the oil fill cap and oil drain bolt to drain the oil into the drain pan. Account for the sealing washer on the drain bolt.



CAUTION

Ensure no foreign material enters the crankcase.

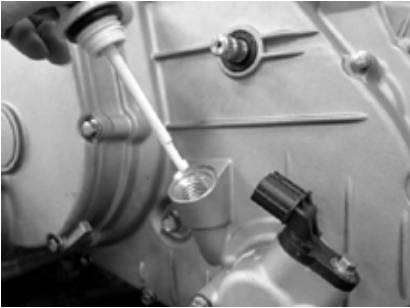

5. Using an oil filter wrench, remove the oil filter and dispose of it properly. Do not reuse the oil filter.

NOTE: Clean up any excess or spilled oil after removing the oil filter.

6. Apply a thin coating of new oil to the O-ring gasket on the new oil filter. Ensure the O-ring is positioned correctly, then install the new oil filter. Tighten securely.
7. Install a new sealing washer and install the engine oil drain plug. Tighten to 11 ft lb (15 N-m).
8. Pour the recommended amount and type of engine oil into the oil filler hole. Install the filler plug.
9. Start the engine (while the vehicle is outside on level ground) and allow it to idle for a few minutes.
10. Turn the engine “OFF” and wait approximately one minute. Recheck the oil level and adjust as necessary.
11. Inspect the area around the drain plug and oil filter for leaks.

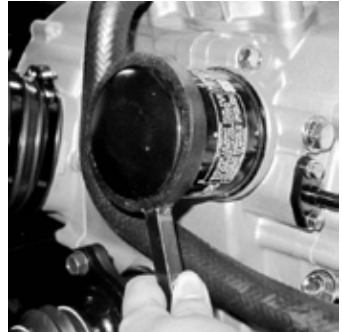

NOTE: Dispose of the used oil and filter in an environmentally proper way.

General Maintenance

Front Gear Case Oil Inspection/Change

Inspect the gear lubricants in your vehicle according to the Maintenance Schedule. When checking the lubricant, if low, use only the approved SAE 80W-90 hypoid type fluid and use the following procedure:

TO CHECK:

1. Park the vehicle on level ground.
2. Remove the front differential level plug.

NOTE: The fluid level should be up to the threads of the level plug.

3. Add oil if necessary.
4. Install the level plug and tighten securely.

TO CHANGE:

1. Park the vehicle on level ground.
2. Place a suitable drain pan under the vehicle.
3. Remove the front differential level plug, fill plug and the differential oil drain bolt. Allow oil to drain.
4. Install the front differential oil drain bolt and tighten to 4 ft lb (5 N-m).
5. Fill the front differential with SAE 80W-90 until the oil level reaches the threads on the level plug.
6. Install the oil level plug and oil fill plug. Tighten securely.

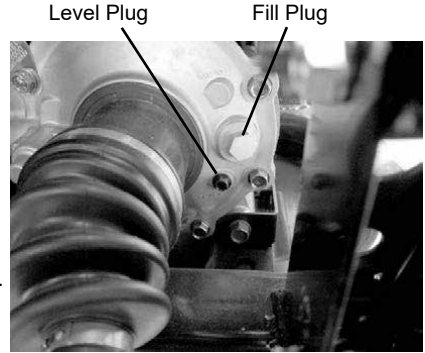

Drain Bolt



CAUTION

Inspect the oil for any signs of metal filings or water. If either are present, take your vehicle to an authorized ARGO dealer for service.

Rear Gear Case Oil Inspection/Change

Inspect the gear lubricants in your vehicle according to the Maintenance Schedule. When checking the lubricant, if low, use only the approved SAE 80W-90 hypoid type fluid and use the following procedure:

1. Park the vehicle on level ground.
2. Remove the rear gear case level plug.

NOTE: The fluid level should be up to the threads of the level plug.

3. Add oil if necessary.
4. Install the level plug and tighten securely.

TO CHANGE:

1. Park the vehicle on level ground.
2. Place a suitable drain pan under the vehicle.

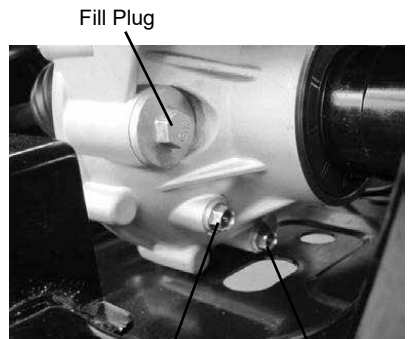

Level Plug

Drain Bolt

General Maintenance

3. Remove the rear gear case level plug, fill plug and the gear case oil drain bolt. Allow oil to drain.
4. Install the rear gear case oil drain bolt and tighten to 4 ft lb (5 N-m).
5. Fill the rear gear case with SAE 80W-90 hypoid type fluid until the oil level reaches the threads on the level plug.
6. Install the oil level plug and oil fill plug. Tighten securely.



CAUTION

Inspect the oil for any signs of metal filings or water. If either are present, take your vehicle to an authorized ARGO dealer for service.

Brake Hoses

Carefully inspect the hydraulic hoses for cracks or other visible damage. If damage is found, take the vehicle to an authorized ARGO dealer for service.

Hydraulic Brakes



WARNING

Be sure to inspect the hydraulic brake system before every use. Always maintain the brakes and the brake fluid level according to the Maintenance Schedule.

1. Check the brake fluid level. Ensure the fluid level is between the upper and lower marks.

Upper level mark MAX —

Lower level mark MIN —



CAUTION

Be careful not to spill any brake fluid when filling the brake fluid reservoir. Brake fluid can damage the finish of plastic components. Wipe up any spilled brake fluid immediately.

General Maintenance

Brake Pads

The clearance between the brake pads and brake discs is adjusted automatically as the brake pads wear. The only required maintenance is to replace brake pads when they become worn. To check the thickness of the brake pads, use the following procedure:

1. Park the vehicle on level ground and engage the parking brake.
2. Loosen the wheel nuts on the front wheel to be removed. Do not remove the wheel nuts from the wheel studs.
3. Using a suitable jack, elevate the OHRV. Support the vehicle on a support stand.



WARNING

Ensure the vehicle is safely supported on the stand to avoid injury.

4. Remove the wheel nuts.
5. Remove the wheel.
6. Measure the thickness of each brake pad. If the thickness of the pads are less than 0.039 in (1 mm), take your vehicle to an authorized ARGO dealer to have the brake pads replaced.

7. Install the wheel and install wheel nuts.

NOTE: Ensure the tapered side of the wheel nuts face the wheel rim.

8. Tighten in a crisscross pattern in 20 ft lb (27 N-m) increments to a final torque specification of 45 ft lb (61 N-m) (steel wheel), 60 ft lb (81 N-m) (aluminum wheel).
9. Remove the support stand and jack.

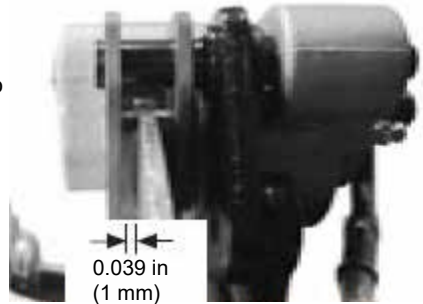

Protective Rubber Boots

The protective rubber boots over the drive shafts should be inspected periodically per the Maintenance Schedule.

Ball Joint Boots (Upper/Lower and Left/Right)

1. Park the vehicle on level ground and engage the parking brake.
2. Loosen the wheel nuts on the front wheels. Do not remove the wheel nuts from the wheel studs.
3. Using a suitable jack, elevate the vehicle. Support the vehicle on a support stand.



WARNING

Ensure the OHRV is safely supported on the stand to avoid injury.

4. Remove the wheel nuts.
5. Remove the wheel.

General Maintenance

6. Inspect the four ball joint boots for cracks, tears, perforations, or any other visible damage.
7. Check the ball joint for free-play by grasping the steering knuckle and turning it from side to side, and up and down.
8. If boot damage is noted or ball joint free-play seems excessive, contact an authorized ARGO dealer for service.
9. Install the wheel and reinstall the wheel nuts.



NOTE: Ensure the tapered side of the wheel nuts face the wheel rim.

10. Tighten in a crisscross pattern in 20 ft lb (27 N-m) increments to a final torque specification of 45 ft lb (61 N-m) (steel wheel), 60 ft lb (81 N-m) (aluminum wheel).
11. Remove the support stand and jack.

Tie Rod Boots (Inner/Outer and Left/Right)

1. Park the vehicle on level ground and engage the parking brake.
2. Loosen the wheel nuts on the front wheels. Do not remove the wheel nuts from the wheel studs.
3. Using a suitable jack, elevate the vehicle. Support the vehicle on a support stand.



WARNING

Ensure the OHRV is safely supported on the stand to avoid injury.

4. Remove the wheel nuts.
5. Remove the wheel.
6. Inspect the four tie rod boots for cracks, tears, perforations, or any other visible damage.
7. Check the tie rod end for free-play by grasping the tie rod near the end and attempting to move it up and down.
8. If boot damage is noted or tie rod end free-play seems excessive, contact an authorized ARGO dealer for service.
9. Install the wheel and reinstall the wheel nuts.



NOTE: Ensure the tapered side of the wheel nuts face the wheel rim.

10. Tighten in a crisscross pattern in 20 ft lb (27 N-m) increments to a final torque specification of 45 ft lb (61 N-m) (steel wheel), 60 ft lb (81 N-m) (aluminum wheel).
11. Remove the support stand and jack.

General Maintenance

Drive Axle Boots

1. Inspect all drive axle boots for cracks, tears, perforations, or any other visible damage.
2. If boot damage is noted, contact an authorized ARGO dealer for service.



Wheel Removal

1. Park the vehicle on level ground and ensure the shift lever is in the "P" (Park) position.
2. Loosen the wheel nuts on the wheel to be removed. Do not remove the wheel nuts from the wheel studs.
3. Using a suitable jack, elevate the vehicle. Support the vehicle on a support stand.



WARNING

Ensure the OHRV is safely supported on the stand to avoid injury.

4. Remove the wheel nuts.
5. Remove the wheel.

Wheel Installation

NOTE: When reinstalling a wheel, tighten the wheel nuts in a criss-cross pattern. Be sure the tapered side of the wheel nuts face the wheel rim.

1. Install the wheel and reinstall the wheel nuts.
2. Tighten in a crisscross pattern in 20 ft lb (27 N-m) increments to a final torque specification of 45 ft lb (61 N-m) (steel wheel), 60 ft lb (81 N-m) (aluminum wheel).
3. Remove the support stand and jack.

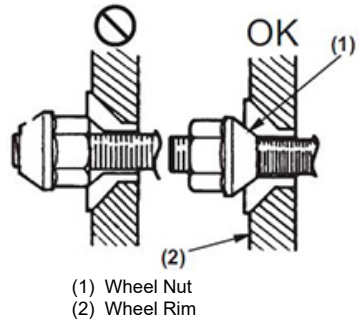

NOTE: The arrow mark (base model) on the tire must point in the rotating direction of the wheel. LE model tires are bi-directional.



General Maintenance

Battery

The battery is located under the hood of your vehicle. After initial service, batteries require regular cleaning and recharging in order to deliver peak performance and maximum service life. The procedures listed in this manual are recommended for cleaning and maintaining lead-acid batteries. Always read and follow instructions provided with battery chargers and battery products.

NOTE: You can perform your own battery maintenance if you are qualified to do so. If you do not feel qualified, take your vehicle to an authorized ARGO dealer for battery service. As with all other periodic maintenance, you are responsible for any charges associated with these services.



WARNING

POTENTIAL HAZARD

Allowing open flames or sparks near the battery.

WHAT CAN HAPPEN

Gases may explode and possibly cause injury.

HOW TO AVOID THE HAZARD

Do not allow open flames or sparks near the battery.

NOTE:

- **When the vehicle is to be stored for an extended period, remove the battery from the vehicle and charge it fully. Store it in a cool, dry place. If the battery is to be left on the vehicle, disconnect the negative cable from the battery terminal.**
- **Battery posts, terminals and related accessories contain lead and lead compounds. Wash hands after handling.**

Battery Capacity:

1. Make sure the ignition switch is in the "OFF" position.
2. Remove the battery hold-down and then disconnect the battery cables.
3. Disconnect the negative (-) terminal lead from the battery first, then disconnect the positive (+) terminal lead.
4. Remove the battery from the battery compartment. Thoroughly wash the battery and the battery compartment with mild soap and water.

NOTE: If the battery posts, cable ends, or the battery case has a buildup of white/green powder residue, apply water and baking soda mixture to neutralize the acid residue and rinse with warm soapy water.

5. Use a wire brush to clean the battery posts and cable ends, remove all corrosive buildup. Replace any damaged cables.
6. Use a multimeter to test the battery voltage. The voltage for a fully charged battery should be at least 12.5 Volts DC.

NOTE: If the meter indicates the proper voltage, the battery can be reinstalled into the battery compartment.

7. If the meter indicates low voltage, charge the battery using the guidelines below.

General Maintenance



WARNING

Any time service is performed on a battery, the following must be observed: keep sparks, open flame, cigarettes, or any other flame away. Always wear safety glasses. Protect skin and clothing when handling a battery. When servicing a battery in an enclosed space, keep the area well-ventilated. Make sure battery venting is not obstructed.

- A. When using an automatic battery charger, always follow the charger manufacturer's instructions.



CAUTION

Never exceed the battery's standard charging rate.



WARNING

An overheated battery from improper charging could explode causing severe injury or death. Always monitor charging times and charge rates carefully. Stop charging a battery if it becomes very warm to the touch. Allow it to cool before resuming any type of charging.



CAUTION

To avoid damage from the vehicles electronic fuel injection components, do not remove or install a battery wire when the ignition switch is in the "ON" position.

8. After charging the battery for the specified amount of time, remove the battery charger and allow the battery to sit and cool for 1 to 2 hours.
9. Test the battery voltage again after the battery has cooled. The meter should read at least 12.5 Volts DC. If the voltage is as specified, the battery is ready to be reinstalled into the battery compartment.

NOTE: If the voltage in step 9 is below specifications, charge the battery an additional 1 - 5 hours and retest. If the voltage level is proper, then the battery can be reinstalled into the battery compartment.

10. Reinstall the battery into the battery compartment and apply a light coat of dielectric grease on the battery posts and cable ends.



CAUTION

Before installing the battery, ensure the ignition switch is in the "OFF" position.

11. Connect the battery cables (positive (+) cable first) and then the negative (-) cable.
12. Reattach the battery hold-down.



CAUTION

Connecting the battery cables in reverse (positive (+) to negative (-) and negative (-) to positive (+) can cause serious damage to the electrical system.

General Maintenance

Charging / Maintenance Charging

NOTE: ARGO recommends the use of a battery charger/maintainer. Maintenance charging is required on all batteries not used for more than two weeks or as required by battery drain.

1. When charging a battery in the vehicle, be sure the ignition switch is in the OFF position.
2. Clean the battery terminals with a solution of baking soda and water.

NOTE: The sealing strip should NOT be removed and NO fluid should be added.

3. Ensure the charger and battery are in a well-ventilated area and the charger is unplugged from the 110-volt electrical outlet.
4. Connect the red terminal lead from the charger to the positive (+) terminal of the battery; then connect the black terminal lead of the charger to the negative (-) terminal of the battery.
5. Plug the battery charger/maintainer into a 110-volt electrical outlet.
6. Follow charging instructions supplied with the charger/maintainer.

NOTE: Not using a battery charger with the proper float maintenance will damage the battery if connected over extended periods.

7. Once the battery has reached full charge, unplug the charger from the 110-volt electrical outlet.

NOTE: If, after charging, the battery does not perform to operator expectations, bring the battery to an authorized ARGO dealer for further troubleshooting.

Jump-Starting

NOTE: ARGO does not recommend jump-starting a vehicle with a dead battery but rather to remove the battery, service it, and correctly charge it.



WARNING

Improper handling or connecting of a battery may result in severe injury including acid burns, electrical burns, or blindness as a result of an explosion. Always remove rings and watches.



WARNING

Any time service is performed on a battery, the following must be observed: keep sparks, open flame, cigarettes, or any other flame away. Always wear safety glasses. Protect skin and clothing when handling a battery. When servicing battery in enclosed space, keep the area well-ventilated. Make sure battery venting is not obstructed.

General Maintenance

Spark Plug

Your vehicle is equipped with a specific spark plug (see “Specifications” for the correct spark plug). The appearance of the insulator on a used spark plug will help determine if it is the proper one for your vehicle.

A light brown insulator indicates that the spark plug is correct. A white or dark insulator indicates that the engine may need to be serviced or adjustments made. Consult an authorized ARGO dealer if the plug insulator is not a light brown color.

To help prevent cold weather fouling (a buildup of carbon and unburned fuel on the spark plug) make sure you thoroughly warm up your vehicles engine before riding.

Before inspecting a spark plug, clean the area around the spark plug to prevent any dirt from entering the engine when remove or installing the spark plug.

Adjust the spark plug’s ground electrode gap to 0.028 - 0.032 in. (0.7 - 0.8 mm).

Use a wire-type feeler gauge to check the gap.

When installing a spark plug, be sure to tighten it securely. A new spark plug should be tightened 1/2 turn once the washer makes contact with the cylinder head. A used spark plug should be tightened 1/8 - 1/4 turn once the washer makes contact with the cylinder head.

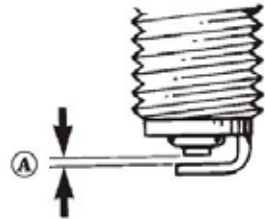

A. Spark plug gap

Air Filter

The air filter inside the air filter housing must be kept clean to provide good engine power, gas economy and to prevent premature engine wear. If you use your vehicle under normal conditions, service the filter at the intervals specified. If you ride it in dusty, wet, or muddy conditions, inspect and service the filter more frequently. Use the following procedure to remove the filter and then inspect and clean it.

1. Remove the seat.
2. Remove the air cleaner cover.
3. Remove the air filter element.

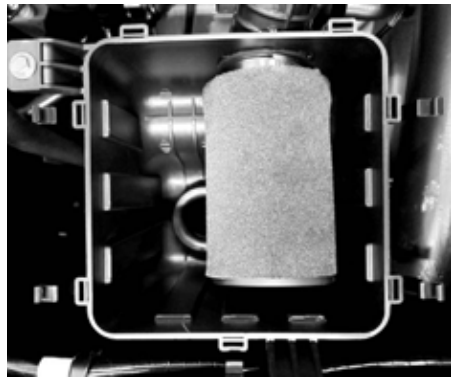

WARNING

POTENTIAL HAZARD

Using low flash point solvents or gasoline to clean the air filter element.

WHAT CAN HAPPEN

Low flash point solvents or gasoline can catch fire or explode increasing the risk of an accident or injury.

HOW TO AVOID THE HAZARD

Use parts cleaning solvent to clean the air filter element.

General Maintenance



CAUTION

Do not twist the air filter element when squeezing it.

4. Fill an adequately sized wash pan with a non-flammable solvent and wash the air filter clean of debris.
5. Squeeze the air filter by pressing it between the palms of both hands to remove excess solvent. Do not twist or ring-out the air filter or you may damage it.
6. Dry the air filter.
7. Generously spray oil onto the air filter and work the oil into the filter.
8. Squeeze the element to remove any excess oil.



CAUTION

A torn air filter can cause damage to your vehicles engine. Dirt or dust may get inside the engine if the air filter is torn. Carefully inspect the air filter for tears before and after cleaning it. Replace the air filter with a new one if it is torn or damaged in any way.

9. Clean any dirt or debris from inside the air cleaner.
10. Reinstall the air filter and cover.
11. Reconnect the inlet boot and tighten the clamp securely.
12. Reinstall the seat.

Draining the V-Belt Cover

NOTE: If the vehicle has been driven through water, the V-Belt cover must be drained of any liquid.

1. Place the vehicle on a flat, level surface.
2. Remove the drain bolt from the cover to allow liquid to drain out.
3. Position the shift lever to the neutral "N" or park "P" position; then start the engine.
4. Increase and decrease the engine RPM several times to force out any additional liquid; then stop the engine.
5. Reinstall the drain bolt and tighten securely.

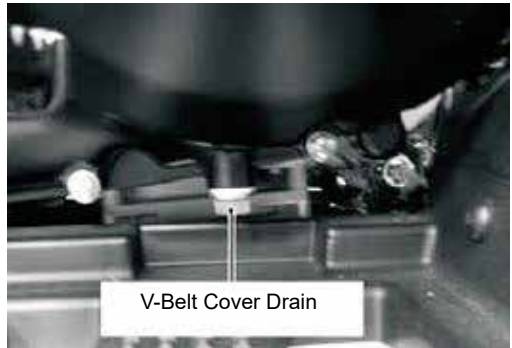

NOTE: The V-belt and pulleys should be inspected every 500 miles and the belt replaced when necessary.

General Maintenance

Tires



WARNING

Always use the size and type of tires specified for your ARGO OHRV. Refer to the specifications chart in this manual for tire-related information and always maintain proper tire inflation pressure.

Tire Replacement

This vehicle has low-pressure tubeless tires. Air is sealed by the contact surfaces of the inner rim and the tire bead. If either the inner rim or tire bead are damaged, air may leak. Be extremely careful not to damage these areas when replacing tires. It is very important to use the proper tools when repairing or replacing tires to prevent damage to the tire, the tire bead or the rims. If you do not have access to the proper tools or lack the technical ability, have your tires serviced by an authorized ARGO dealer.



WARNING

The use of worn-out tires on your vehicle can be dangerous and can increase the risk of an accident.



CAUTION

When breaking the tire bead loose from the wheel, be extremely careful not to damage the inner wheel surface or the tire bead.



WARNING

Use only ARGO approved tires on your vehicle when replacing tires. Failure to do so could result in unstable operation.

Muffler / Spark Arrester

The muffler on this OHRV is equipped with a spark arrester which must be periodically cleaned. Refer to the intervals listed in the Maintenance Schedule and clean the spark arrester using the procedure listed below.



WARNING

Before service, wait for the muffler to properly cool to avoid possible burns.

1. Remove the three cap screws securing the spark arrester assembly to the muffler and then remove the spark arrester.
2. Using a suitable brush, clean the carbon deposits from the screen, taking care to not damage the screen.

NOTE: If the spark arrester screen or gasket is damaged in any way, they must be replaced.

3. Install the spark arrester assembly and secure with the cap screws. Tighten securely.



General Maintenance



WARNING

POTENTIAL HAZARD

Improper cleaning of the spark arrester.

WHAT CAN HAPPEN

Could injure the eyes.

Could cause burns.

Could cause carbon monoxide poisoning, possible leading to death.

Could start a fire.

HOW TO AVOID THE HAZARD

When cleaning the spark arrester:

Always let the exhaust system cool prior to touching exhaust components.

Do not start the engine when cleaning the exhaust system.

Light Bulb Replacement

The wattage rating of each bulb is listed below. When replacing a burned out bulb, always use the same wattage rating.

Headlight	12V/35W	Brakelight	12V/5W
Rear Light	12V/21W/5W	Position Light	12V/5W



CAUTION

Use only bulbs that are specified in this manual as replacement bulbs on this vehicle.

Headlight

NOTE: The LED headlights are fragile and must be replaced as an assembly. HANDLE WITH CARE.

To replace the headlight, use the following procedure:

1. Ensure the ignition switch is in the "OFF" position.
2. Disconnect the wiring connector from the back of the headlight.
3. Remove the four screws securing the headlight housing to the grille.
4. Remove the two screws securing the headlight to the headlight housing.
5. To install, reverse the above procedure.



General Maintenance

Running Lights

NOTE: The LED lights are fragile and must be replaced as an assembly. HANDLE WITH CARE.

To replace the running light, use the following procedure:

1. Ensure the ignition switch is in the "OFF" position.
2. Disconnect the wiring connector from the back of the running light.
3. Remove the screw securing the running light to the grille.
4. To install, reverse the above procedure.



Taillight/Brake Light

1. Disconnect the taillight/brake light connector.
2. Remove the two cap screws and nuts securing the tie-down to the cargo box.
3. Remove the six screws securing the rear fender to the cargo box and remove the fender.
4. Remove the taillight/brake light socket from the light assembly by rotating the socket counterclockwise. Rotate the bulb counterclockwise to remove from the socket.
5. To install the taillight/brake light, insert the bulb into the socket and turn clockwise. Insert the socket into the taillight assembly and turn clockwise.
6. Place the rear fender onto the cargo box and secure using the six screws previously removed. Install the tie-down in the cargo box using the two cap screws and nuts.
7. Connect the taillight/brake light connector.

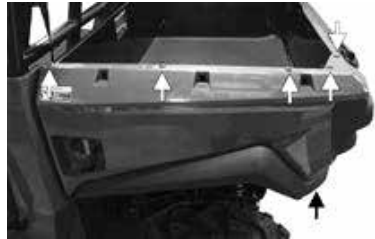
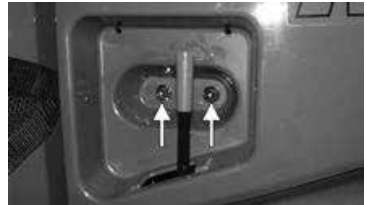

General Maintenance

Checking / Adjusting Headlight Aim

Headlights can be adjusted vertically and horizontally. The projected center of the HIGH beam should be used for vertical and horizontal aiming.

1. Position the vehicle on a flat, level surface so the headlights are approximately 20 ft (6.1 m) from a vertical aiming surface.

NOTE: There should be an average operating load in the vehicle when adjusting the headlight aim.

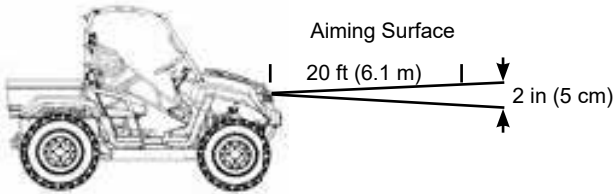

2. Measure the distance from the floor to the midpoint of each headlight.
3. Make horizontal marks on the aiming surface using the measurements obtained in step 2.
4. Make vertical marks on the aiming surface which intersect the horizontal marks directly in front of the headlights.
5. Start the vehicle and turn on the low beam lights. **DO NOT USE HIGH BEAM.**
6. Proper aim is obtained when the most intense beam is centered on the vertical mark 2 in (5 cm) below the horizontal mark on the aiming surface.
7. To raise or lower the headlight beam, turn the adjustment screw "IN" to raise the beam or "OUT" to lower the beam.



General Maintenance

Fuses

The OHRV fuses are located under the front access panel next to the battery. If there is any type of electrical system failure, always check the fuses first.

1. Ensure the ignition switch is in the "OFF" position.
2. Open the fuse box cover.

NOTE: To remove a fuse, compress the locking tabs on either side of the fuse cover and lift it out.

3. Remove the old fuse.
4. Install a new fuse into the fuse holder.
5. Close the fuse box cap. Ensure the locking tabs are secure.



CAUTION

Always replace a failed fuse with a fuse of the same type and rating. If the new fuse fails after a short period of use, consult an authorized ARGO dealer immediately.

- ① ② ③ ④ ⑤ ⑥

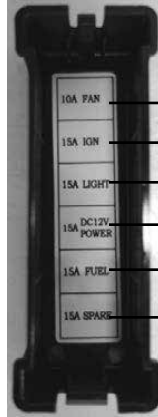

- ⑥ Fan Motor - 15A
⑤ Ignition - 15A
④ Light - 15A
③ DC 12V Power - 15A
② Fuel - 15A
① Spare - 15A



WARNING

POTENTIAL HAZARD

Using an improper fuse.

WHAT CAN HAPPEN

An improper fuse can cause damage to the electrical system which could lead to a fire.

HOW TO AVOID THE HAZARD

Always use a fuse of the specified rating. Never use a material in place of the proper fuse.

General Maintenance

NOISE REGULATION

TAMPERING WITH NOISE CONTROL SYSTEM PROHIBITED:

Federal law prohibits the following acts or the causing thereof: (1) The removal or rendering inoperative by any person other than for purposes of maintenance, repair, or replacement of any device or element of design incorporated into any new vehicle for the purpose of noise control prior to its sale or delivery to the ultimate purchaser or while it is in use or (2) the use of the vehicle after such device or element of design has been removed or rendered inoperative by any person.

“AMONG THOSE ACTS PRESUMED TO CONSTITUTE TAMPERING ARE THE ACTS LISTED BELOW”.

These acts include tampering with the following systems; i.e., modification, removal, etc.

- Exhaust system: Muffler
Exhaust pipe
Silencer
- Intake system: Air cleaner case
Air cleaner element
Intake duct

NOTES

Troubleshooting

Engine doesn't turn over

Possible Cause	Solution
Failed fuse	Replace the fuse
Low battery voltage	Recharge battery to 12.5 VDC
Loose battery connections	Check all connections and ignition
Loose solenoid connections	Check all connections and ignition

Engine turns over but fails to start

Possible Cause	Solution
Out of fuel	Refuel
Clogged fuel filter	Inspect, clean or replace
Water is present in fuel	Drain the fuel system and refuel
Fouled or defective spark plug	Inspect plug, replace if necessary
Crankcase filled with water or fuel	Immediately see your dealer
Low battery voltage	Recharge battery to 12.5 VDC
Mechanical failure	See your dealer

Engine pings or knocks

Possible Cause	Solution
Poor quality or low octane fuel	Replace with recommended fuel
Incorrect ignition timing	See your dealer
Incorrect spark plug gap or heat range	Set gap to specs or replace plug

Engine backfires

Possible Cause	Solution
Weak spark from spark plug	Inspect, clean and/or replace spark plug
Incorrect spark plug gap or heat range	Set gap to specs or replace plug
Old or non-recommended fuel	Replace with new fuel
Incorrectly installed spark plug wire	See your dealer
Incorrect ignition timing	See your dealer
Mechanical failure	See your dealer

Engine runs irregularly, stalls or misfires

Possible Cause	Solution
Fouled or defective spark plug	Inspect, clean and/or replace spark plug
Worn or defective spark plug wire	See your dealer
Incorrect spark plug gap or heat range	Set gap to specs or replace plug
Loose ignition connection	Check all connections and tighten
Water present in fuel	Replace with new fuel

Troubleshooting

Possible Cause	Solution
Possible lean mixture fuel cause	
Low or contaminated fuel	Add or change fuel, clean fuel system
Low octane fuel	Replace with recommended fuel
Possible rich mixture fuel cause	
Fuel is very high octane	Replace with lower octane fuel
Engine stops or loses power	
Possible Cause	Solution
Out of fuel	Refuel
Kinked or plugged fuel vent line	Inspect and replace
Water present in fuel	Replace with new fuel
Fouled or defective spark plug	Inspect, clean and/or replace spark plug
Worn or defective spark plug wire	See your dealer
Incorrect spark plug gap or heat range	Set gap to specs or replace plug
Loose ignition connection	Check all connections and tighten
Low battery voltage	Recharge battery to 12.5 VDC
Incorrect fuel	Replace with recommended fuel
Clogged air filter	Inspect, clean or replace
Other mechanical failure	See your dealer
Overheated engine	Clean engine exterior See your dealer

SECTION 9

Preparation For Storage



CAUTION

Prior to storing your OHRV, it must be properly serviced to prevent rusting and component deterioration.

Cleaning the Vehicle

Frequent, thorough cleaning of your OHRV will not only enhance its appearance but will improve its general performance and extend the useful life of many components.

1. Before cleaning the OHRV:
 - a. Block off the end of the exhaust pipe to prevent water entry. A plastic bag and strong rubber band may be used.
 - b. Make sure the spark plug and all filler caps are properly installed.
2. If the engine case is excessively greasy, apply degreaser with a paintbrush. Do not apply degreaser to wheel axles.
3. Rinse the dirt and degreaser off with a garden hose. Use only enough pressure to do the job.



WARNING

- Wet brakes may have reduced stopping ability, increasing the chance of an accident. Test the brakes after washing. Apply the brakes several times at slow speeds to let friction dry out the linings.
- Excessive water pressure may cause water seepage and deterioration of wheel bearing, brakes, transmission seals and electrical devices. Many expensive repair bills have resulted from improper high-pressure detergent applications such as those available in coin-operated car washes.

4. Once most of the dirt has been hosed off, wash all surfaces with warm water and mild, detergent-type soap. An old toothbrush or bottle brush is handy for hard to reach places.
5. Rinse the vehicle off immediately with clean water and dry all surfaces with a chamois, clean towel or soft absorbing cloth.
6. Clean the seat with vinyl upholstery cleaner to keep the cover pliable and glossy.
7. Automotive type wax may be applied to all painted and chrome plated surfaces. Avoid combination cleaner-waxes. Many contain abrasives, which may mar the paint or protective finish. When finished cleaning, start the engine and let it idle for several minutes.

Storage

Short Term

Always store your vehicle in a cool, dry place and if necessary, protect it against dust with a porous cover.



WARNING

Storing the vehicle in a poorly ventilated room or covering it with a tarp while it is still wet, will allow water and humidity to seep in and cause rust. To prevent corrosion, avoid damp cellars, stables and area where strong chemicals are stored.

Long Term

Before storing your vehicle for several months:

1. Follow all the instructions in the “Cleaning” section of this chapter.
2. Fill up the fuel tank and add fuel stabilizer to prevent the fuel from deteriorating.
3. Perform the following steps to protect the cylinder, piston rings, etc. from corrosion.
 - a. Remove the spark plug cap and spark plug.
 - b. Pour a teaspoonful of engine oil into the spark plug bore.
 - c. Install the spark plug cap onto the spark plug and then place the spark plug on the cylinder head so that the electrodes are grounded.
 - d. Turn the engine over several times with the starter.
 - e. Remove the spark plug cap from the spark plug and then install the spark plug and the spark plug cap.
4. Lubricate all control cables and the pivoting points of all levers and pedals.
5. Check and if necessary, correct the tire air pressure and then block up the vehicle so that all of its wheels are off the ground. Alternatively, turn the wheels a little every month in order to prevent the tires from becoming degraded in one spot.
6. Cover the muffler outlet with a plastic bag to prevent moisture from entering it.
7. Remove the battery and fully charge it. Store it in a cool, dry place and charge it once a month.

Do not store the battery in an excessively cold or warm place less than 32° F (0° C) or more than 86° F (30 C).

8. Make necessary repairs before storing the vehicle.



LIMITED WARRANTY

Ontario Drive & Gear Limited (hereinafter "ARGO") extends a limited warranty on each new ARGO ATV, XTV, and SSV and on each genuine ARGO part and accessory sold by an authorized ARGO dealer. The limited warranty on an ARGO ATV, XTV, or SSV is provided to the original retail purchaser; however, the balance of the unused warranty may be transferred to another party through an ARGO dealer, but any such transfer will not extend the original term of the warranty. Warranty coverage is limited to the country in which the original retail purchase occurs and to the original retail purchaser resident in that country or, if transferred to a resident in that country for the balance of the remaining warranty.

The warranty is validated upon examination of said parts by ARGO or an authorized ARGO dealer. ARGO reserves the right to inspect such parts at its factory for final determination if warranty should apply. ARGO will repair or replace, at its option (including any related labor charges), any parts that are found to be warrantable in material or workmanship. This repair work must be done by an authorized ARGO dealer. No transportation charges, rental charges, or inconvenience costs will be paid by ARGO.

ARGO does not assume any liability for incidental or consequential damages.

WARRANTY COVERAGE PERIOD

1. Standard Warranty - 1 year from the date of sale.

Argo Promotional Extended Warranty provided at the time of sale will follow the Standard Warranty guidelines and coverage. Excludes batteries.

The warranty does not cover normal wear, abuse, or corrosion.

WARRANTY LIMITATIONS AND EXCLUSIONS

This ARGO limited warranty will become null and void if:

1. Failure to perform the proper break-in procedure and all related maintenance, storage procedures (if stored for extended periods), and/or service as recommended in the Operator's Manual.
2. Repairs and/or adjustments made by anyone other than an authorized ARGO dealer unless instructed by ARGO.
3. Any modification, addition, or removal of parts unless instructed to do so by ARGO.
4. Removal of the engine for use in another vehicle.
5. Use of improper fuels, lubricating oils, or spark plug(s).
6. Vehicle has been involved in an accident or subject to misuse, abuse, or negligent operation, including overloading.
7. Use of the vehicle in any way for racing purposes.
8. Removal or mutilation of the Product Identification Number or Engine Serial Number.
9. Damage due to improper transportation.
10. Use of aftermarket or unapproved parts, accessories or attachments not sold by ARGO.



11. Damage caused by Acts of God, such as storm damage, hail, lightning, and other environmental conditions.
12. Collision, fire, theft, freezing, vandalism, riot, explosion, or objects striking the vehicle.
13. Tampering with the vehicle's hour meter.

In consideration of the foregoing, any implied warranty is limited in duration to the warranty periods set forth. This warranty gives you specific legal rights, and you may also have other rights which vary from state/province to state/province and country to country. Some jurisdictions do not allow limitations on how long an implied warranty lasts, so the above limitations may not apply to you.

WARRANTY PROCEDURE / OWNER RESPONSIBILITY

At the time of sale, a Training Certificate (if applicable) or an Owner Registration form is to be completed by the selling dealer and consumer. The receipt of the form by ARGO is a condition precedent to warranty coverage. It is the selling dealer's responsibility to retain and/or submit appropriate electronic registration to initiate warranty coverage.

The selling dealer is responsible to furnish the consumer a signed copy of the form which must be presented to the dealer when requesting warranty service. The registration form is the consumer's proof of ownership and warranty eligibility. The form is to be used by the dealer to validate the warranty claim. Retain your copy of the Owner Registration form and keep it in a safe place.

When warranty repair is suspected, the vehicle should be taken to an authorized ARGO dealer, who has the primary responsibility to perform warranty repairs.

The authorized ARGO dealer will examine the vehicle or part to determine if a warrantable condition exists. If a warrantable condition appears to exist, the dealer will repair or replace, at ARGO's option, including any related labor costs, all parts that are found to be warrantable and any other parts which the warrantable part caused to be damaged.

It is the owner's responsibility to maintain and service the vehicle in accordance with ARGO's recommendations in the Operator's Manual. To protect yourself and your vehicle, follow all safety and service tips. ARGO will NOT warrant repairs required as a result of not performing standard operator maintenance, storage procedures, and service as outlined in the Operator's Manual.

Should you have any questions concerning the warranty, contact an authorized ARGO dealer.

EPA EMISSIONS CONTROL SYSTEM WARRANTY:

LIMITED WARRANTIES EMISSION CONTROL SYSTEMS:

ARGO warrants to the owner of any 2025 and subsequent model year OHRV that the OHRV is designed, built and equipped to conform at the time of sale with all applicable emission standards and is free from defects in materials and workmanship which would cause it to fail to conform with applicable requirements during the specified time and mileage limits.

A qualified repair shop or person of the owner's choosing may maintain, replace, or repair emission control devices and systems with original or equivalent replacement parts. However, warranty, recall and all other services paid or by ARGO must be performed at an authorized ARGO service center except for the emergency condition described below.

Your Warranty Rights and Obligations:

In the United States and Canada, new OHRVs must be designed, built and equipped to meet stringent Federal anti-smog standards. ARGO must warrant the emissions control system on your OHRV for the periods of time listed below, provided there has been no abuse, neglect or improper maintenance of your OHRV. Your emissions control system may include parts such as the sensors, the ignition and the engine computer. Also included may be hoses, connectors and other emissions-related assemblies. Where a warrantable condition exists, ARGO will repair your OHRV at no cost to you, including diagnosis, parts, and labor.

Owner's Responsibility:

As the OHRV owner, you should also be aware that ARGO may deny you warranty coverage if your vehicle or a part has failed due to abuse, neglect, improper maintenance or unapproved modifications. If you have any questions regarding your warranty rights and responsibilities or if an authorized ARGO dealer cannot repair your OHRV or honor your claim within a reasonable period of time, contact ARGO or assistance at 1-218-683- 5366. If you are not satisfied with the way in which a warranty claim is resolved by ARGO, you may write directly to:

Director, Gasoline Engine Compliance Center
Compliance Division
U.S. EPA
2000 Traverwood Drive
Ann Arbor, MI 48105

You must operate and maintain your OHRV according to the requirements of the Owner's Manual including the maintenance schedule. This schedule is designed to keep your OHRV emission control systems functioning properly and safely. You should keep receipts and records of maintenance and service but ARGO will not deny a warranty claim solely because of lack of maintenance records.

If an ARGO service center is not available within 100 miles, ARGO will reimburse you for those emergency repairs, including diagnosis, covered by the Emissions Warranties. Labor reimbursement is at a geographically-appropriate hourly labor rate for ARGO recommended time allowance. For reimbursement, present the replacement parts and a copy of the paid receipt to ARGO.

The use of replacement parts not equivalent to the original parts may impair the effectiveness of your OHRV emissions control systems. If such a replacement part is used in the maintenance or repair of your OHRV and an authorized ARGO dealer determines it is defective or caused a failure of a warranted part, your claim for repair to bring your OHRV into compliance with applicable standards may be denied. If the part in question is not related to the reason your OHRV fails to meet the standards, your claim will not be denied.

Emissions Warranty Coverage:

This warranty begins on the date the OHRV is delivered to the first purchaser, or the date it is first used as a demonstrator, lease, or company OHRV, whichever comes first and continues for the time and mileage listed below:

Time: 30 months OR

Mileage: 5,000 kilometers (3,100 miles) whichever comes first.

Warranted Parts:

Fuel Tank
Fuel Cap
Fuel Line
Fuel Line Fittings
Clamps*
Carburetor
Press. Relief Valves*
Control Valves*
Control Solenoids*
Electronic Controls*
Control Cables*
Control Linkages*
Purge Valves
Vapor Hoses
Liq/Vapor Separator
Air Intake System
Press Relief Fittings*
Vacuum Control Diaphragms*
Engine
Engine Electronic Control Module*
Ignition System*
Sensors*
Exhaust System and Components
Spark Arrestor
Fuel Injection System and Components

*Components that are part of the engine, fuel injection system, fuel evaporative system and emissions control system.

Maintenance Record

MAINTENANCE INTERVAL	DATE OF SERVICE	MILEAGE	SERVICING DEALER NAME AND ADDRESS	REMARKS
1 Month				
3 Months				
6 Months				
12 Months				
18 Months				
24 Months				
30 Months				
36 Months				
42 Months				
48 Months				
54 Months				
60 Months				



WARNING

Improper OHRV use can result in SEVERE INJURY or DEATH.



**ALWAYS USE
AN APPROVED
HELMET AND
PROTECTIVE
GEAR**



**NEVER USE
ON PUBLIC
ROADS**



**NEVER
OPERATE
WITH MORE
THAN ONE
PASSENGER**



**NEVER USE
WITH DRUGS
OR ALCOHOL**

NEVER operate:

- without proper training or instruction
- at speeds too fast for your skills or the conditions
- on public roads - a collision can occur with another vehicle
- with more than one passenger

ALWAYS:

- use proper riding techniques to avoid vehicle overturns on hills and rough terrain and in turns
- avoid paved surfaces - pavement may seriously affect handling and control

**LOCATE AND READ OPERATOR'S MANUAL.
FOLLOW ALL INSTRUCTIONS AND WARNINGS.**