



2025 OPERATOR'S MANUAL



Xplorer XC 90

*This vehicle is not a toy and is intended for use
by children at least 12 years old.*

NOTE

Read this manual before you operate your ARGO ATV. It contains safe operating instructions and warns the user about potential hazards that can result in personal injury.

Warnings are identified in the text by the following symbol:



WARNING

Warning text warns the user about potential hazards that can result in personal injury or death.

Cautions are identified in the text by the following symbol:



CAUTION

Caution text contains cautions that can prevent damage to the ATV.

This manual is based on the latest product information available at the time of printing. ARGO reserves the right to make changes at any time and without obligation.

Reproduction of any part of this publication is prohibited without prior written permission.

© 2024 ARGO



WARNING

WARNING: This product may contain fuels, oils and fluids, battery posts, terminals and related accessories which contain lead and lead compounds and other chemicals identified by the State of California to potentially cause cancer, birth defects, and other reproductive harm. These chemicals are found in vehicles, vehicle parts and accessories, both new and replacements. During maintenance, these vehicles generate used oil, waste fluids, grease, fumes and particulates, all identified by the State of California to potentially cause cancer, birth defects, and other reproductive harm.

For more information go to:

www.P65Warnings.ca.gov

PREFACE

This manual describes the controls, operation and basic maintenance procedures for the ARGO ATV from date of printing. Please take the time to read this manual carefully, for your safety and that of others. By following these instructions, you will ensure extended, trouble free operation of your ATV.

For maintenance and adjustment of the engine, refer to the manufacturer's operation and maintenance manual included in your ATV's information package.

Before you drive your ARGO ATV, make sure you understand how to use all controls, particularly the brakes and steering system. Learn how to drive your ATV in an open level area, away from buildings, trees and other obstacles, until you are completely familiar with its operating characteristics. Drive very slowly until your driving skills improve, and drive with caution and consideration at all times. The risk of accident or injury is greatest during the first weeks of use. Take special care during this period. ALWAYS RESPECT OUR ENVIRONMENT.

CAUTION TO THE ARGO OWNER/OPERATOR:

Before you operate your new ATV, we highly recommend these important points:

- Read your Owner's Manual.
- This ATV is intended for use by children at least 12 years old. Never allow children under the age of 12 to operate this ATV.
- Parents: It is very important that your child or children understand and follow the instructions, cautions and warnings contained in this manual before operating this ATV under adult supervision.
- Take the training course before operating your ATV, ask your dealer for more information.
- This ATV is designed for one person only.
- This Operator's Manual is provided to make the operator aware of proper operating procedures. It also includes useful information related to general care and maintenance of your ATV.
- Prior to any ATV operation, it is absolutely essential to read and comprehend each section in this manual to develop an understanding of your ATV and to ensure your safety. After reviewing this manual, store it in a dry and easily accessible place for future reference.
- This manual is designed to help familiarize you with safety, assembly and operation. Read this manual and follow the recommendations to help ensure safe and efficient operation.
- The information contained within this manual was current at the time of printing. Constant improvement in the design and quality of components may result in discrepancies between the actual ATV and information presented in this manual.
- To view the most up-to-date manuals or to order a replacement Operator's Manual, please contact an authorized dealer or visit the ARGO website.
- This manual has been prepared to instruct you in the safe and responsible operation of your ATV. Read and abide by all safety alert information about this ATV. If you do not understand any part of this manual, contact your local dealer for additional information and clarification. As the operator of this ATV, you are in complete control. Only you can prevent an accident from happening.
- Right-hand and left-hand, as used in this manual, are determined by facing the direction the ATV will travel while in use unless otherwise stated.
- Never modify the vehicle in any way that will alter the weight distribution of the vehicle, decrease its stability or increase the speed beyond the factory specifications. Such modifications can cause serious personal injury or death. The manufacturer prohibits and disclaims responsibility for any such modifications or any other alteration which would adversely affect the safety of the vehicle. The vehicle manufacturer reserves the right to incorporate engineering and design changes to products in this manual, without obligation to include these changes on units sold previously. The information contained in this manual may be revised periodically by the manufacturer, and therefore is subject to change without notice.

TABLE OF CONTENTS

SECTION 1 - Introduction

Introduction	1
Getting Acquainted With Your ATV	3

SECTION 2 - Safety Information

Safety Information	5
Warnings	10
Hangtags and Warning Labels	19

SECTION 3 - Specifications

Specifications	23
----------------------	----

SECTION 4 - Description and Identification

Identification Number Records	25
Location of Parts and Controls	25
Control Functions	
Ignition Switch	27
Handlebar Switches	27
Engine Stop Switch	27
Headlight Switch	28
Starter Button	28
Kick Starter	28
Remote Engine Stop Switch	28
Throttle Lever	29
Speed Limiter	29
Front Brake Lever	30
Rear Brake Lever	30
Parking Brake Lever Lock	30
Fuel Tank Cap	31
Fuel Valve	31
Flag Pole Bracket	31
Gear Selector	32
Shifting the Transmission	32
Seat Removal / Installation	33
Storage Compartment	34
Tool Kit	34

SECTION 5 - Getting to Know Your ATV

Getting to Know Your ATV	35
Before Riding	35
Rider Preparation - Age Recommendation	35
Pre-Operation Checks	35
Safe Riding Rules	35
Protective Apparel	35
Weight Limits	36
Accessories	36

No Modifications	36
For Off-Road Use Only	36
Ride Only When Visibility is Good	36
Remote Engine Stop Switch for New Riders	37
Braking	37
Sliding or Skidding	37
Turning Your ATV	38
Climbing Uphill	39
Riding Downhill	40
Crossing A Slope	40
Riding Over Rough Terrain	40
Crossing Through Shallow Water	40
Parking	40
What To Do If	41

SECTION 6 - Before You Ride

Engine Break-In	43
Pre-Operation Checks	43
Pre-Operation Check Table	44
Front and Rear Brakes	45
Fuel	45
Engine and Transmission Oil	46
Chain	47
Throttle Lever	47
Fittings and Fasteners	47
Lights	47
Switches	47
Tires	47
How to Measure Tire Pressure	48
Tire Wear Limit	48
Starting a Cold Engine - Electric Starter	49
Starting a Cold Engine - Without Electric Starter	49
Starting a Warm Engine	50
Warming up Engine	50
Parking	50
Parking on a Slope	50

SECTION 7 - Operation

Mounting the ATV	51
Starting the Engine	51
Emergency Starting the Engine	52
Braking / Stopping	52
Parking	52
Turning Your ATV	53
Climbing Uphill	54
Riding Downhill	55
Crossing a Slope	55
Crossing Through Shallow Water	56
Riding Over Rough Terrain	56

Sliding or Skidding.....	57
Crossing Roads.....	57
Cold Weather Operation.....	57
Stopping the ATV.....	58
Stopping the Engine.....	58

SECTION 8 - General Maintenance

General Maintenance.....	59
Maintenance Schedule.....	60
Engine Oil - Checking.....	61
Engine Oil - Change Oil Filter Cleaning.....	61
Transmission Oil - Checking.....	62
Transmission Oil - Change.....	62
Transmission Oil - Refill.....	63
Spark Plug Inspection.....	63
Air Filter Cleaning.....	63
Valve Clearance Adjustment.....	64
Shock Absorbers.....	64
Idle Speed Adjustment.....	65
Throttle Lever Adjustment.....	65
Front Brake Shoe Inspection.....	65
Rear Brake Pad Inspection.....	66
Front Brake Lever Free Play Adjustment.....	66
Brake Fluid Inspection.....	67
Drive Chain Slack - Checking.....	68
Drive Chain Slack - Adjusting.....	68
Drive Chain Cleaning and Lubrication.....	69
Cable Inspection and Lubrication.....	69
Brake Lever Lubrication.....	69
Knuckle Shaft and Rear Fork Shaft Lubrication.....	69
Wheel - Removal and Installation.....	70
Battery.....	70
Battery Removal.....	71
Battery Installation.....	71
Charging / Maintenance Charging.....	72
Jump Starting.....	72
Fuse Replacement.....	74
Fuse Holder.....	75
Spark Arrester Cleaning.....	76
Noise Regulation.....	77
Troubleshooting.....	78

SECTION 9 - Preparation For Storage

Preparation For Storage.....	81
------------------------------	----

SECTION 10 - Warranty

Limited Warranty.....	83
Emissions Warranty.....	85
Maintenance Record.....	87

SECTION 1

Introduction

ARGO welcomes you to its growing family of new product owners. This All-Terrain Vehicle (ATV) has been designed with care and built by skilled workers using quality materials.

Proper setup, maintenance and safe operating practices will help you get years of satisfactory use from this ATV.

Your safety and the safety of all ARGO users is of the greatest concern to us. You will find numerous safety statements in this manual. Please read and follow them carefully. Always be safety conscious when you operate your ARGO and remember it is a motorized vehicle.

Please take the time to develop your driving skills before attempting new challenges. Observe the recommendations outlined in this Operator's Manual and remember; some things are just impossible, even with an ARGO.

WELCOME TO THE WORLD WIDE ARGO FAMILY!



PLEASE TAKE A FEW MOMENTS TO GET ACQUAINTED WITH YOUR ATV BY READING THIS OWNER'S MANUAL

NOTE:

The manufacturer DISCLAIMS LIABILITY FOR ERRORS IN THIS MANUAL, and SPECIFICALLY DISCLAIMS LIABILITY FOR INCIDENTAL AND CONSEQUENTIAL DAMAGES resulting from the use of the information and material in this manual.

Name: _____

Address: _____

Telephone: _____

Purchase Date (mm/dd/yyyy): _____

Model: _____

Frame Number: _____

Engine Number: _____

Key Number: _____

- Before operating this ATV, the owner and each operator must understand that this ATV was not designed or manufactured to meet specifications for use on public roads, streets, highways or thoroughfares.
- The owner and operator(s) must read and understand all the instructions for proper assembly and safe operation, as well as the instructions concerning the engine and all other portions of the ATV, as described and illustrated in this manual.
- This ATV is NOT to be operated by anyone under 12 years of age.
- This ATV is NOT a toy.
- Be sure to follow the recommended maintenance schedule and service your ATV accordingly.

PREVENTATIVE MAINTENANCE IS EXTREMELY IMPORTANT TO THE SAFE OPERATION AND LONGEVITY OF YOUR ATV

We advise you to follow the recommended maintenance program as outlined in this manual. This program is designed to ensure all critical components on this ATV are thoroughly inspected at specified intervals.

Precautionary Measures

Protect Your Sport

- Know all State and local laws relating to ATV riding,
- Respect your ATV
- Respect the environment, and
- You will gain the respect of other fellow riders.

GETTING ACQUAINTED WITH YOUR ATV

This manual will provide you with a good basic understanding of the features and operation of this ATV. This manual includes important safety information. It provides information about special techniques and skills necessary to ride the ATV. It also includes basic maintenance and inspection procedures. If you have any questions regarding the operation or maintenance of your ATV, please consult dealer.

IMPORTANT SAFETY MESSAGE:

- The Consumer Product Safety Commission has concluded that ALL-TERRAIN VEHICLES (ATVs) may present a risk of DEATH or SEVERE INJURY in certain circumstances. While accidents may occur for many reasons:
 - As of September, 2021 the year 2019 is the most recent year of reporting for fatalities that CPSC considers complete. CPSC is aware of 1,513 people, including many children, have died in accidents associated with ATVs during a 3-year period from 2017 through 2019
 - Many people have become severely paralyzed or suffered severe internal injuries as a result of accidents associated with ATVs.
 - Every month, thousands of people are treated in hospital emergency rooms for injuries received while riding an ATV.

■ You should be aware that AN ATV IS NOT A TOY AND CAN BE

HAZARDOUS TO OPERATE. An ATV handles differently from other vehicles, including motorcycles and cars. A collision or rollover can occur quickly, even during routine maneuvers such as turning and driving on hills and over obstacles, if you fail to take proper precautions.

- Read this manual carefully and completely before operating your ATV. Make sure you understand all instructions.
- For Type 1 ATVs, Category Y (Youth Model) ATV. An ATV intended for recreational and/or utility use by an operator age 12 or older.
- Pay attention to the warning and notice labels on the ATV.
- Never operate an ATV without proper training or instruction. For a training course, please consult a dealer.
- This ATV is designed for a single rider, do not carry a passenger.
- This ATV is designed exclusively for off-road use. It is not designed, properly equipped or licensed to be safely operated on public streets and highways.
- This ATV complies with all applicable off-road noise level and spark arrester laws and regulations in effect at the time of manufacture.
- Please check your local riding laws and regulations before operating this ATV.
- For your safety, follow and understand all CAUTIONS, WARNINGS and LABELS contained in this Operator's Manual.
- Keep this Operator's Manual with your ATV at all times for reference.

FAILURE TO FOLLOW THE WARNINGS and CAUTIONS CONTAINED IN THIS MANUAL CAN RESULT IN SERIOUS INJURY OR DEATH.

IMPORTANT

Operate this ATV with safety constantly in mind. Off-road vehicles face unpredictable and often hazardous terrain conditions. It is ultimately the operator's responsibility to handle the ATV safely within its limitations and to decide when and where to travel.

**FOR MORE INFORMATION ON OUR FULL PRODUCT OFFERING,
VISIT OUR WEBSITE www.argoxtv.com**

- For a detailed description of warranty coverage for your ATV, refer to the Warranty section found in this Owner's Manual or visit our website.
- For a detailed description of the emissions warranty for your ATV, refer to the Emissions Warranty section of this Owner's Manual or visit our website.

***ARGO WANTS YOU TO BE SATISFIED WITH YOUR NEW ATV.
IF YOU DO NOT UNDERSTAND ANY PART OF THIS MANUAL OR ARE NOT
SATISFIED WITH THE SERVICE RECEIVED, PLEASE TAKE THE FOLLOWING
ACTIONS:***

Discuss the matter with your dealership service manager. Make sure they are aware of any problems so they can assist you.

REPLACEMENT PARTS, ACCESSORIES and SERVICE

- Most replacement parts and accessories are typically available from your dealer. For immediate availability and convenience, it is recommended items be ordered from an authorized dealer. Take this manual and all supplements to the dealer when ordering parts in person.
- Orders may be subject to a minimum fee. A listing of authorized service providers in your area is also available on the website.
- Unapproved installation of parts or accessories can create a substantial safety hazard and increase the risk of personal injury.
- Use authorized parts only.



WARNING

All engine exhaust contains carbon monoxide, a deadly gas. Carbon Monoxide is a colorless, odorless, tasteless gas, which may be present even if you do not see or smell any engine exhaust.

Avoid Carbon Monoxide Poisoning.

- Do not run engine indoors. Even if you try to ventilate engine exhaust with fans or open windows and doors, carbon monoxide can rapidly reach dangerous levels.
- Do not run engine in poorly ventilated or partially enclosed areas such as barns, garages or carports.
- Do not run engine outdoors where engine exhaust can be drawn into a building through opening such as windows and doors.

SECTION 2

Safety Information

An ATV is NOT a Toy and Can Be Hazardous To Operate

An ATV handles differently from other vehicles such as motorcycles and cars. A collision or rollover can occur quickly, even during routine operation such as turning, driving over obstacles, on hills or rough terrain, if you do not take necessary precautions.

SEVERE INJURY OR DEATH can result if you do not follow these instructions:

- Read this manual and all CAUTION/WARNING labels carefully and follow the operating procedures described.
- Never operate an ATV without proper instruction. Take a training course. Beginners should receive training from a certified instructor. Contact the ATV Safety Institute at: U.S. - 1-800-887-2887 or Canada - 1-613-739-1535 to find out about a training course nearest you. Visit www.atvsafety.org to register for free ATV safety training. ARGO is offering a \$100 incentive for completion of the ASI approved safety training.
- * FOR MORE INFORMATION ABOUT ATV SAFETY in the United States, call the Consumer Product Safety Commission at 1-800-638-2772 or visit www.cpsc.gov or visit www.atvsafety.org.
- Parents: It is very important that your child or children understand and follow the instructions, cautions and warnings contained in this manual before operating this ATV under adult supervision.
- Never allow anyone under 12 years of age to operate this ATV.
- Never allow a child to operate a Y-12+ ATV without adult supervision and never allow continued use of an ATV by a child if the child does not have the abilities to operate it safely.
- Some operators, even at the age of 12, may not be able to operate an ATV safely; parents should supervise such operator of the ATV at all times. Parents should permit continued use only if they determine that the operator has the ability to operate the ATV safely.
- Never carry a passenger.
- Never permit a guest to operate this ATV unless the guest has read this manual and all product labels and has completed the training course.
- Never operate an ATV on any paved surfaces, including sidewalks, driveways, parking lots, and streets.
- Never operate this ATV on any public street, highway, or road (dirt or gravel).
- Never operate an ATV without wearing an approved helmet that fits properly. You should also wear eye protection (goggles or face shield), gloves, boots, long-sleeved shirt or jacket, and long pants.
- Never consume alcohol or drugs before or while operating this ATV.
- Never operate at excessive speeds. Always travel at a speed which is proper for the terrain, visibility and operating conditions, and your experience.
- Never attempt wheelies, jumps, or other stunts.
- Always inspect this ATV each time you use it to make sure it is in safe operating condition. Always follow the inspection, maintenance procedures and schedules described in this manual.
- Always keep both hands on the handlebars and both feet on the footrests of the ATV during operation.
- Always go slow and use caution when operating on unfamiliar terrain. Always be alert to changing terrain conditions when operating the ATV.

An ATV is NOT a Toy and Can Be Hazardous To Operate

- Never operate the ATV on hills too steep for the abilities of the operator or the ATV. Practice on smaller hills before attempting larger hills.
- Never operate on excessively rough, slippery, or loose terrain.
- Always follow proper procedures for turning as described in this manual. Practice turning at slow speeds before attempting to turn at faster speeds. Do not turn at excessive speed.
- Always have the ATV inspected by an authorized ARGO dealer if it has been involved in any type of accident.
- **NEVER OPERATE UP OR DOWN HILLS STEEPER THAN 15 DEGREES**
- Always follow proper procedures for climbing hills as described in this manual. Check the terrain carefully before you start up any hill. Never climb hills with slippery or loose surfaces. Shift your weight forward. Never accelerate suddenly. Never go over the top of any hill at a high rate of speed.
- Always follow proper procedures for going down hills and for braking on hills as described in this manual. Check the terrain carefully before you start down any hill. Shift your weight towards the back of the ATV. Never go down a hill at a high rate of speed. Avoid going down a hill at an angle which would cause the ATV to lean sharply to one side. Go straight down the hill whenever possible.
- Always follow proper procedures for crossing the side of a hill as described in this manual. Avoid hills with slippery or loose surfaces. Shift your weight to the uphill side of the ATV. Never attempt to turn the ATV around on any hill until you have mastered the turning techniques described in this manual on level ground. Avoid crossing the side of a steep hill if possible.
- Always use proper procedures if you stall or roll backward when climbing a hill. To avoid stalling, maintain a steady speed when climbing a hill. If you stall or roll backwards, follow the special instructions for braking described in this manual. Dismount the ATV on the uphill side or to either side if pointed straight uphill. Turn the ATV around and mount the ATV following the special instructions described in this manual.
- Always check for obstacles before operating in a new area.
- Never attempt to operate over large obstacles, such as large rocks or fallen trees. Always follow proper procedures when operating over obstacles as described in this manual.
- Always use caution when skidding or sliding. On slippery surfaces, such as ice, go slow and be very cautious in order to reduce the chance of skidding or sliding out of control.
- Never operate an ATV in fast flowing water or in water deeper than the footrests. Remember that wet brakes may have reduced stopping capability. Test your brakes after exiting any water. If necessary, apply the brake lightly several times to let friction dry out the pads.
- Always use the size and type of tires specified in this manual.
- Always maintain proper tire pressure as described in this manual.
- Never improperly install or improperly use accessories on your ATV.
- Never exceed the stated load capacity for this ATV. One operator only. No cargo, No passengers, or No towing.

An ATV is NOT a Toy and Can Be Hazardous To Operate

IMPORTANT MESSAGE TO PARENTS

Your child's safety is very important to ARGO. That is why we urge you to read this message before you let any young rider operate this ATV. Off-road riding can be fun. However, an ATV is not a toy and it can be hazardous to operate. As with any youth activity involving speed and skill such as bicycling or skateboarding, poor judgment can result in injuries and we don't want that to happen! You can help prevent accidents by making good decisions about if, when, and how your child rides this ATV.

Evaluate Riding Readiness

The first decision you'll need to make is whether your child is ready to ride. Riding readiness varies widely from one person to another, and while the minimum age recommended for this ATV is 12 years of age, there are other factors that you should consider.

Physical size and ability are important considerations. To help determine whether a youngster is big enough for this ATV, have them stand up on the footboards and grasp the hand grips. While the youngster holds this position, check that they have at least three inches (8cm) of clearance between the ATV seat and the youngster's "seat of the pants". A rider needs at least three inches (8cm) of clearance so they can stand up for balance and comfort, and to shift their body forward, backward and from side to side.

Also make sure your youngster can comfortably reach and work all the controls. For example, can they turn the handlebars all the way to the right and left? Can they operate the throttle and brake levers while they hold onto the hand grips? If not, the youngster is not physically ready to ride this ATV.

Before you let a youngster ride an ATV, decide whether they are physically, mentally and emotionally ready to ride.



Patience And Practice

Even if a youngster takes a certified training course, it's up to you to ensure your youngster's safety. Remember, learning to ride a ATV is a gradual step-by-step process. It takes time, patience and practice.

To help you regulate your youngster's rate of learning, your ATV was delivered with an **adjustable throttle limiter**. We recommend that all beginning riders start off with the throttle limiter adjusted as delivered. The limiter may be adjusted to gradually increase maximum speed as the beginner becomes more familiar with operating the ATV. For adjustment and removal instructions, see page 29.

An ATV is NOT a Toy and Can Be Hazardous To Operate

Always Supervise Young Riders

Supervision is another important obligation of parents. Even after youngsters have become skilled off-road riders, make sure they always have adult supervision while riding. It also helps to regularly remind young riders to follow the instructions and warnings in this manual. And remember, it's the parent's responsibility to see that the ATV is properly maintained and kept in safe operating condition.

If you choose to lend your ATV to another rider, do make sure that any riders under 16 years old will have adult supervision. Your youngster should understand that the decision to lend the ATV is yours.

ARGO recommends the use of the below safety gear before operation:

Clothing and Gear

While riding your ATV, you will find it important to dress correctly to prevent personal injury. Below is the minimum protection recommended to wear during every ride:

1. Helmet
2. Eye Protection
3. Long Pants
4. Long Sleeve Shirt
5. Gloves
6. Boots/Ankle Protection

Helmet

There are many different types and styles of helmet to choose from today. Be sure to choose a helmet that complies with the current standards of the U.S. Department of Transportation (DOT), The Snell Memorial Foundation, or the American National Standards Institute (ANSI). Helmets that comply with one or more of the above standards have a defined label located on the inside or outside of the helmet.

These helmets should provide full-face protection.

If you damage your helmet, obtain a new one immediately.

Remember: Your helmet is not providing any safety if the chin strap is not securely fastened.

Eye Protection

Wear eye protection, such as goggles, to completely surround your eyes to prevent any dirt or other items from getting into your eyes. Sunglasses are not a form of protection as they are open on the sides.

Long Pants and Long Sleeve Shirt

Protection from sticks, branches, long grass, airborne objects, or anything that could possibly scrape your skin. The heavier the material, the better the protection.

Gloves

Gloves will provide protection to your hands from any debris or incimate weather. Choose a glove that provides a gripping surface as well as protection.

An ATV is NOT a Toy and Can Be Hazardous To Operate

Boots/Ankle Protection

Choose a boot that protects the largest possible of your leg (preferable up to your knee) and can handle impact of rocks, dirt or branches. Choose a boot that has low heel and a good tread will help prevent your feet from slipping off the footrests in wet or rugged conditions.

First Aid and Survival

Prepare for the unexpected. Emergencies and accidents happen and are ever worse when you are not prepared for them. Below is a recommended list of items you should have before every ride:

1. Tools

Routine maintenance will generally eliminate the need for emergency repairs during your ride. Riding on rough terrain could cause some fasteners to loosen. Carrying the right tools can prevent down time. Below is a recommended list of tools to carry on your ride:

- a. Spark plug
- b. Spare parts
- c. Rope
- d. Tool kit
- e. Duct tape
- f. Headlight/Taillight bulbs

2. Water

Water is an important part of your ride regardless of the duration. Heat exhaustion and heat stroke can suddenly shorten your ride. If you become dehydrated, you may find yourself unable to safely operate your ATV.

3. Identification

If something happens to you while operating your ATV, emergency personnel will need to know who you are and who to call in the event of an emergency. It may be possible, you are unable to provide that information due to injury. Put identification in your pocket before you ride.

4. First Aid Kit/ Emergency Kit with Flashlight

Several items are recommended in your Emergency Kit including a *Flashlight*; *Matches* in the event you need to start a fire; *Flares* for signaling help; *First Aid Kit* to include bandages, tape, gauze, antiseptic spray, etc. if an injury should occur; *Money*.

5. Communication device - it may be necessary to make an urgent phone call.

6. Map/GPS

Warnings



WARNING

POTENTIAL HAZARD

Failure to follow the age recommendations for this ATV.

Failure to supervise children under the age of 16 on ATV models intended for their use.

WHAT CAN HAPPEN

If children use ATVs that are not recommended for their age, severe injury or death can result.

Even though a child may be within the age group for which an ATV is recommended, he or she may not have the skills, abilities, or judgment needed to operate the ATV safely and may be involved in a serious accident.

HOW TO AVOID THE HAZARD

A child under 12 should never operate this ATV.

Never allow a child under 16 to operate an ATV without adult supervision and never allow continued use of the ATV by a child if he or she does not have the abilities to operate it safely.



POTENTIAL HAZARD

Operating this vehicle without proper instruction.

WHAT CAN HAPPEN

The risk of an accident is greatly increased if the operator does not know how to operate this vehicle properly in different situations and on different types of terrain.

HOW TO AVOID THE HAZARD

All operators of this vehicle must read and understand this Operator's Manual and all warning and instruction labels prior to operating this vehicle.

POTENTIAL HAZARD

Operating this ATV on paved surfaces.

WHAT CAN HAPPEN

The ATV tires are designed for off-road use only and are not for use on pavement.

Paved surfaces may seriously affect the handling and control of the ATV and may cause the ATV to go out of control.

HOW TO AVOID THE HAZARD

Whenever possible, avoid operating the ATV on any paved surfaces including streets, parking lots, sidewalks, and driveways. If operating on paved surfaces is unavoidable, travel slowly (less than 10 mph) and avoid sudden turns and stops.



WARNING

Indicates a potential hazard that could result in a serious injury or death.

Warnings

POTENTIAL HAZARD

Carrying a passenger on this ATV.

WHAT CAN HAPPEN

Greatly reduces your ability to balance and control this ATV. Could cause an accident, resulting in personal injury or death to you and/or your passenger.

HOW TO AVOID THE HAZARD

Never carry a passenger. The longer seat is to allow the operator to shift positions as needed during operation.



POTENTIAL HAZARD

Operating this ATV on public streets, roads, or highways.

WHAT CAN HAPPEN

You can collide with another vehicle.

HOW TO AVOID THE HAZARD

Never operate this ATV on any public street, road, or highway, even a dirt or gravel one. In many states it is illegal to operate an ATV on public streets, roads, or highways.

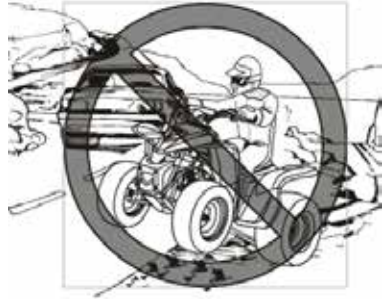

POTENTIAL HAZARD

Operating this ATV after or while consuming alcohol or drugs.

WHAT CAN HAPPEN

Can seriously affect your judgment.
Can cause you to be slow to react.
Can affect your balance and perception.
Can result in an accident.

HOW TO AVOID THE HAZARD

Never consume alcohol or drugs before or while operating this ATV.



POTENTIAL HAZARD

Failure to inspect the ATV before operation.
Failure to properly maintain the ATV.

WHAT CAN HAPPEN

Increases the possibility of an accident or equipment damage.

HOW TO AVOID THE HAZARD

Always inspect the ATV every time you use it. Ensure it is safe operating condition.
Always follow the inspection and maintenance procedures and schedules described in this Operator's Manual.



WARNING

Indicates a potential hazard that could result in a serious injury or death.

Warnings

POTENTIAL HAZARD

Operating this ATV without wearing an approved motorcycle helmet, eye protection, and protective clothing.

WHAT CAN HAPPEN

Operating without an approved helmet increases your chances of a severe head injury or death in the event of an accident.
Operating without eye protection can result in an accident and increases your chances of a severe injury in the event of an accident.
Operating without protective clothing increases your chances of severe injury in the event of an accident.

HOW TO AVOID THE HAZARD

Always wear an approved helmet that fits properly.
You should also wear:
Eye protection (goggles or face shield)
Gloves
Boots
Long sleeved shirt or jacket
Long pants

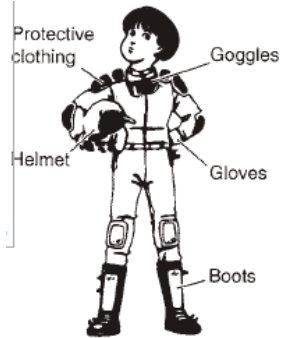

POTENTIAL HAZARD

Operating this ATV at excessive speeds.

WHAT CAN HAPPEN

Increases the chance of losing control of the ATV, which can result in an accident.

HOW TO AVOID THE HAZARD

Always operate at a speed that is proper for the terrain, visibility, operating conditions, and your age and experience.

POTENTIAL HAZARD

Failure to use caution when operating this ATV on unfamiliar terrain.

WHAT CAN HAPPEN

You may encounter hidden rocks, bumps, or holes without enough time to react.
Could result in the ATV going out of control.

HOW TO AVOID THE HAZARD

Use caution when operating on unfamiliar terrain. Always be alert to changing terrain conditions.

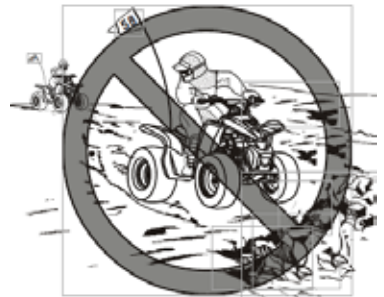

WARNING

Indicates a potential hazard that could result in a serious injury or death.

Warnings

POTENTIAL HAZARD

Attempting wheelies, jumps and other stunts.

WHAT CAN HAPPEN

Increases the chance of losing control of the ATV, which can result in an accident.

HOW TO AVOID THE HAZARD

Never attempt stunts, such as wheelies or jumps. Don't try to show off.

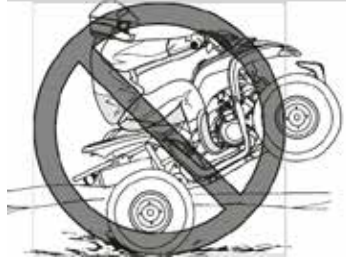

POTENTIAL HAZARD

Failing to keep hands on handlebars or feet on footrests during operation.

WHAT CAN HAPPEN

Removing even one hand or foot can reduce your ability to control the ATV or could cause you to lose your balance and fall off the ATV. If you remove a foot from the footrest, your foot or leg may come into contact with the wheels, which could cause personal injury or cause an accident.

HOW TO AVOID THE HAZARD

Always keep both hands on the handlebars and both feet on the footrests during operation.



POTENTIAL HAZARD

Improper handling of gasoline.

WHAT CAN HAPPEN

Gasoline can ignite and you could be burned. Gasoline is poisonous and can cause injury.

HOW TO AVOID THE HAZARD

Always turn off the engine when refueling.
Do not refuel right after the engine has been running and is still very hot.
Do not spill gasoline on the engine or exhaust pipe/muffler when refueling.
Never refuel while smoking, or while in the vicinity of sparks, open flames, or other sources of ignition such as the pilot lights of water heaters and clothes dryers.
When transporting the machine in another vehicle, be sure it is kept upright and that the fuel cock is in the "OFF" position.
Otherwise, fuel may leak out of the carburetor or fuel tank.

**Never Operate Up or Down Hills
Steeper than 15°**



WARNING

Indicates a potential hazard that could result in a serious injury or death.

Warnings

POTENTIAL HAZARD

Operating on steep hills.

WHAT CAN HAPPEN

This ATV can overturn more easily on steep hills than on level surfaces.

HOW TO AVOID THE HAZARD

Never operate this ATV on hills too steep for the ATV or for your abilities. Practice on smaller hills before attempting larger hills.

POTENTIAL HAZARD

Failure to use caution when operating this ATV on rough, slippery, or loose terrain.

WHAT CAN HAPPEN

You may lose traction or control, which could result in an accident.

HOW TO AVOID THE HAZARD

Do not operate this ATV on rough, slippery, or loose terrain until you have learned and practiced the skills necessary to control this ATV on such terrain.



POTENTIAL HAZARD

Climbing hills improperly.

WHAT CAN HAPPEN

You may lose control, which could result in an accident.

HOW TO AVOID THE HAZARD

Always follow proper procedures for climbing hills.
Always check the terrain carefully before you start up any hill.
Never climb hills with slippery or loose surfaces.
Shift your weight forward.
Never open the throttle suddenly. The ATV may flip over backwards.
Never go over the top of any hill at high speeds. An obstacle, sharp drop, or another vehicle or person may be on the other side.



POTENTIAL HAZARD

Failure to use caution in turns; turning too sharp or aggressive.

WHAT CAN HAPPEN

You may lose control, which could result in an accident.

HOW TO AVOID THE HAZARD

Always follow proper procedure for turning. Practice turning at slower speeds before attempting to turn at faster speeds. Do not attempt to turn at excessive speeds or too sharp for the conditions and for your experience level.



WARNING

Indicates a potential hazard that could result in a serious injury or death.

Warnings

POTENTIAL HAZARD

Going down a hill improperly.

WHAT CAN HAPPEN

You may lose control, which could result in an accident.

HOW TO AVOID THE HAZARD

Always follow proper procedures for going down hills.

Always check the terrain carefully before you start down any hill.

Shift your weight backward.

Never go down a hill at high speeds.

Avoid going down a hill at an angle that would cause the ATV to lean sharply to one side. Go straight down the hill where possible.

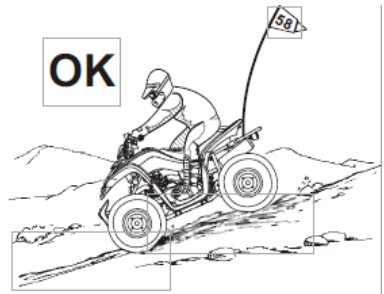

POTENTIAL HAZARD

Stalling, rolling backwards, or improperly dismounting while climbing a hill.

WHAT CAN HAPPEN

You may lose control, which could result in an accident.

HOW TO AVOID THE HAZARD

Use proper gear and maintain steady speed when climbing a hill.

If you lose all forward momentum:

Keep weight uphill.

Apply the brakes.

Engage the parking brake after you are stopped.

If you begin rolling backwards:

Keep weight uphill.

Gradually apply the brakes while rolling backwards.

When fully stopped, engage the parking brake.

Dismount on the uphill side or to a side if pointed straight uphill.

Turn the ATV around and mount following the procedure described in this Operator's Manual.

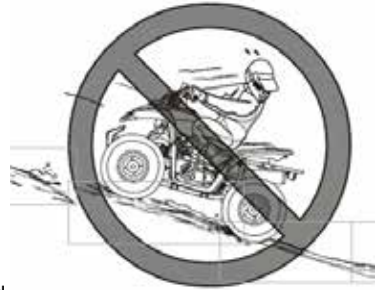

POTENTIAL HAZARD

Operating the ATV with improper tires or improper or uneven tire pressure.

WHAT CAN HAPPEN

You may lose control, which could result in an accident.

HOW TO AVOID THE HAZARD

Always use the size and type of tires specified in this Operator's Manual.

Always maintain proper tire pressure.



WARNING

Indicates a potential hazard that could result in a serious injury or death.

Warnings

POTENTIAL HAZARD

Operating the ATV in deep or fast flowing water.

WHAT CAN HAPPEN

Tires may float, causing loss of traction and loss of control, which could result in an accident.

HOW TO AVOID THE HAZARD

Never operate the ATV in fast flowing water or in water deeper than the footrests.

Remember that wet brakes may have reduced stopping capability.

Test the brakes after exiting the water. If necessary, apply the brakes several times to dry out the brake pads.



POTENTIAL HAZARD

Skidding or sliding.

WHAT CAN HAPPEN

You may lose control, which could result in an accident.

HOW TO AVOID THE HAZARD

Learn to safely control skidding or sliding by practicing at slow speeds on level, smooth terrain.

On extremely slippery surfaces, such as ice or snow, go slow and use caution in order to reduce the chance of skidding or sliding out of control..

POTENTIAL HAZARD

Operating this ATV with improper modifications.

WHAT CAN HAPPEN

Improper installation and improper use of accessories or modification of the ATV may cause changes in operation or handling which, in some situations, may lead to an accident.

HOW TO AVOID THE HAZARD

Never modify this ATV through improper installation or improper use of accessories.

All parts and accessories added to this ATV should be components designed for use on this ATV and should be installed and used according to instructions.

Never install a twist grip throttle. If you have questions, please contact an authorized dealer.

POTENTIAL HAZARD

Improperly operating over obstacles.

WHAT CAN HAPPEN

You may lose control, which could result in an accident.

HOW TO AVOID THE HAZARD

Before operating on unfamiliar terrain, check for obstacles.

Never attempt to operate over large obstacles, such as large rocks or fallen trees.

When going over obstacles, always follow proper procedures.



WARNING

Indicates a potential hazard that could result in a serious injury or death.

Warnings

POTENTIAL HAZARD

Failure to release the parking brake before operating the ATV.

WHAT CAN HAPPEN

Operating the ATV with the parking brake engaged could cause a change in handling or loss of brakes and cause an accident.

HOW TO AVOID THE HAZARD

Always release the parking brake before operating the ATV.

POTENTIAL HAZARD

Improperly crossing hills or turning on hills.

WHAT CAN HAPPEN

You may lose control, which could result in an accident.

HOW TO AVOID THE HAZARD

Avoid crossing the side of hill or turning on a hill whenever possible. Never attempt to turn the ATV around on any hill until you have mastered the turning technique as described in this Operator's Manual. Practice first on level ground.

If you must cross the side of a hill or turn on a hill: Always follow proper procedures described in this Operator's Manual.

Avoid hills with slippery or loose surfaces.

Shift your weight to the uphill side of the ATV.



POTENTIAL HAZARD

Starting or running engine in a closed area.

WHAT CAN HAPPEN

Exhaust fumes are poisonous and may cause loss of consciousness and death within a short period of time.

HOW TO AVOID THE HAZARD

Always operate your ATV outdoors or in an area with adequate ventilation.

POTENTIAL HAZARD

Hot exhaust system.

WHAT CAN HAPPEN

Someone coming in contact with the exhaust system during or after operation could be burned.

HOW TO AVOID THE HAZARD

Do not touch the hot exhaust system.

Do not park the ATV in a place where others might be likely to come in contact with the exhaust system.

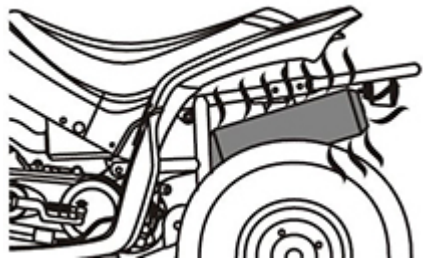

WARNING

Indicates a potential hazard that could result in a serious injury or death.

Warnings

POTENTIAL HAZARD

Operating in areas where you might not be seen by other off-road ATV's.

WHAT CAN HAPPEN

You may be in a collision which may result in personal injury.

HOW TO AVOID THE HAZARD

Always mount a caution flag on the ATV to make you more visible.
Watch carefully for other ATV riders and other vehicles.



POTENTIAL HAZARD

Turning improperly.

WHAT CAN HAPPEN

ATV could go out of control, causing a collision or overturn.

HOW TO AVOID THE HAZARD

Always follow proper procedures for turning as described in this Owner's Manual.
Practice turning at low speeds before attempting to turn at faster speeds. Do not turn at speeds too fast for your skills or the conditions.
Do not turn at excessive speeds.

POTENTIAL HAZARD

Overloading this ATV or carrying or towing cargo.

WHAT CAN HAPPEN

Could cause changes in ATV handling, stability and braking which could lead to an accident or injury.

HOW TO AVOID THE HAZARD

Never exceed the stated maximum weight capacity for this ATV.
Never carry cargo or tow a trailer.



WARNING

Indicates a potential hazard that could result in a serious injury or death.

Hangtags and Warning Labels

Your ARGO Y-12+ ATV comes with various hangtags and several labels containing important safety information related to the vehicle. Anyone who operates the ATV should read and understand the important safety information before operating.

The hangtags and labels are considered to be a permanent part of the ATV. If a label becomes hard to read or comes off the vehicle, contact your ARGO ATV dealer for a replacement.

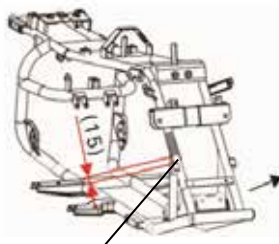
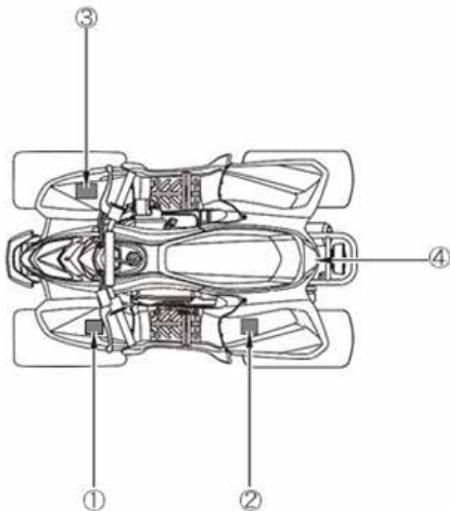

SVIA Certification DECAL

Manufactured by KWANG YANG MOTOR CO., LTD. (KYMCO)
 KWANG YANG MOTOR CO., LTD. (KYMCO) certifies that this
 ATV complies with ANSI/SVIA 1-2017 Standard, and is
 subject to the ARGO USA, Inc. Action Plan on file with the U.S.
 Consumer Product Safety Commission.

085-0983

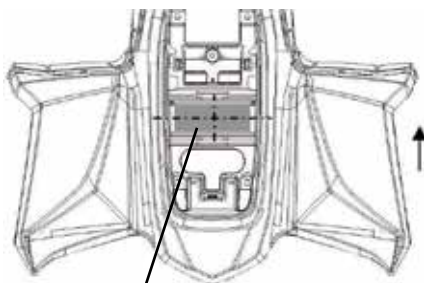

DECAL OF EPA

VEHICLE EMISSION CONTROL INFORMATION / VEHICLE EVAPORATIVE EMISSION CONTROL INFORMATION

MODEL NAME:

ENGINE DISPLACEMENT:

ENGINE FAMILY:

PERMATION FAMILY:

EVAPORATIVE FAMILY:

ENGINE EXHAUST CONTROL SYSTEM:

THIS VEHICLE MEETS U.S. EPA AND CALIFORNIA EXHAUST

REGULATIONS FOR _____ MODEL YEAR NEW ATVS AND IS

CERTIFIED TO _____

EXHAUST EMISSION STANDARDS IN CALIFORNIA.

THIS VEHICLE CONFORMS TO CALIFORNIA EVAPORATIVE

EMISSIONS REGULATIONS APPLICABLE TO _____ MODEL YEAR

NEW ATVS AND IS CERTIFIED TO 1 GRAM TO/G/DAY

EVAPORATIVE EMISSION STANDARDS IN CALIFORNIA.

THIS VEHICLE IS CERTIFIED TO OPERATE ON

UNLEADED GASOLINE.

ENGINE TUNING SPECIFICATIONS:

IGNITION TIMING: NOT ADJUSTABLE

IDLE SPEED:

IDLE MIXTURE:

VALVE CLEARANCE: INTAKE: _____

EXHAUST: _____

SPARK PLUG:

FUEL: UNLEADED GASOLINE ONLY - 87(R+M)/2

OCTANE

OIL: SAE - 30 (SEE OWNER'S MANUAL)

NO OTHER ADJUSTMENT NEEDED.

MANUFACTURED: _____

(MONTH/YEAR)

Argo

Hangtags and Warning Labels

General Use Hangtag



Front



Reverse side

Emissions Hangtag



Front

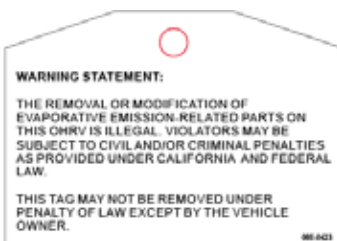

Reverse side

Hangtags and Warning Labels

1

⚠ WARNING

Improper ATV use can result in SEVERE INJURY or DEATH



ALWAYS USE AN APPROVED HELMET AND PROTECTIVE GEAR

NEVER USE ON PUBLIC ROADS

NEVER CARRY PASSENGERS

NEVER USE WITH DRUGS OR ALCOHOL

NEVER operate:

- without proper training or instruction
- at speeds too fast for your skills or the conditions
- on public roads - a collision can occur with another vehicle
- with a passenger-passengers affect balance and steering and increase risk of losing control

ALWAYS:

- use proper riding techniques to avoid vehicle overturns on hills and rough terrain and in turns
- avoid paved surfaces - pavement may seriously affect handling and control

LOCATE AND READ OWNER'S MANUAL
FOLLOW ALL INSTRUCTIONS AND WARNINGS

085-0582

2

⚠ WARNING

Improper tire pressure or overloading can cause loss of control. Loss of control can result in severe injury or death.

- Cold tire pressure:
Front: 3.0 psi (20.6 kPa)
Rear: 3.0 psi (20.6 kPa)
- Maximum weight capacity: 175 lbs (79 kg)

085-0577

3

⚠ WARNING



UNDER 12

Operation of this ATV by children under the age of 12 increases the risk of severe injury or death.

Adult supervision required for children under age 16.

NEVER permit children under age 12 to operate this ATV.

085-0624

4

⚠ WARNING

NEVER ride as a passenger.



Passengers can cause a loss of control, resulting in SEVERE INJURY or DEATH.

085-0582

SECTION 3

Specifications

Specifications

ENGINE AND DRIVE	
Type	Four-Cycle/OHC/Air Cooled
Bore x Stroke	47 x 51.8 mm (1.85 x 1.62 in.)
Displacement	89.9 cc (5.5 cu in.)
Cylinder arrangement	Single cylinder
Compression ratio	10.0:1
Carburetor	PTE (Auto Bystarter)
Starting system	Electric / Kick
Lubrication system	Wet sump
Spark Plug Type	NGK CR7HSA
Spark Plug Gap	0.024 - 0.028 in (0.6 - 0.7 mm)
Brake Type	Front Double Drum - Right Hand Operation Rear Hydraulic Disc - Left Hand Operation w/Brake Lever Lock
Clutch type	Dry, centrifugal automatic
Speed adjuster	0.72 in (18 mm) maximum
Throttle lever free play	0.12-0.2 in (3-5 mm)
CHASSIS	
Length (Overall)	57.6 in (1440 mm)
Height (Overall)	37 in (925 mm)
Width (Overall)	35.6 in (905 mm)
Seat height	25.5 in (650 mm)
Wheel base	37.9 in (965 mm)
Fra. Minimum ground clearance	6.0 in (150 mm)
RR. Minimum ground clearance	4.0 in (100 mm)
Suspension	Front: Single A-arm Rear: Swing arm
Shock Absorber	Front: Coil spring / Oil damper Rear: Coil spring / Oil damper
Electrical	Ignition: C.D.I. Generator system: C.D.I. Magneto Battery type: 12V, 4AH
Tires	Type: Tubeless Size: Front - 18 x 7-8 Size: Rear - 18 x 9-8

MISCELLANEOUS

Basic Weight (with oil and full fuel tank)	270.6 lbs (123 kg)
Gas Tank Capacity (Rated)	1.38 gal (5.3 L)
Gas Tank Reserve Capacity	0.38 gal (1.5 L)
Gasoline (Recommended)	87 Octane Regular Unleaded
Engine Oil (Recommended)	API Service SE, SF, SG type or higher
Engine Oil Capacity (Approximate)	Change - 0.74 qt (0.7 L) Total - 0.84 qt (0.8 L)
Transmission Lubricant (Recommended)	SAE #90
Transmission Lubricant Capacity	Change - 0.12 qt (0.11 L) Total - 0.13 qt (0.12 L)
Brake Light	12V/5W
Air Filter	Engine - Wet type element V-belt compartment - Dry type element
Specifications subject to change without notice.	

SECTION 4

Description and Identification

Identification number records

Record the key identification number, frame serial number, engine serial number and model code information for assistance when order replacement parts.

KEY NO. _____

FRAME NO. _____

ENGINE NO. _____

MODEL CODE _____



Key identification number

The key identification number is stamped on the hang tag as shown in the illustration.

Frame and Engine Serial Number

The frame serial number is stamped on the front of the frame.

The engine serial number is stamped on the left crankcase.

These numbers are required by the dealer to complete any Warranty process. No warranty will be allowed by ARGO if the VIN or ESN has been tampered with in any way.



(1) Frame serial number



(1) Engine serial number

MODEL CODE: GTE06

Location of Parts and Controls

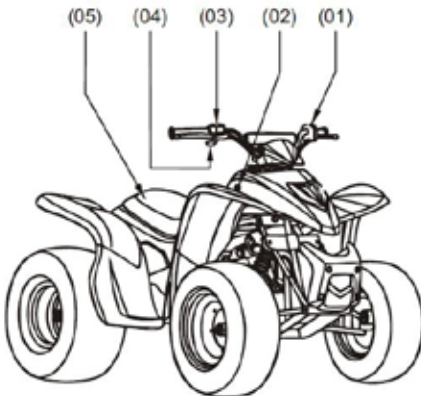

1. Handlebar switch
2. Ignition switch
3. Speed limiter
4. Throttle lever
5. Seat

NOTE: The machine you have purchased may differ slightly from those shown in the illustrations of this manual.

Location of Parts and Controls

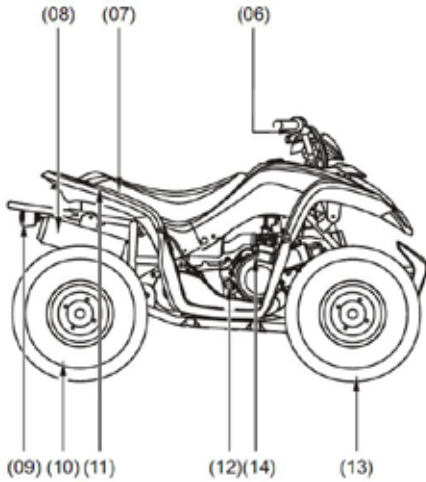

6. Remote engine stop switch
7. Storage compartment, containing:
Owner's Manual
Air pressure gauge
Tool kit
8. Exhaust pipe
9. Taillight / Stop light
10. Rear wheel
11. Seat lock lever
12. Oil filler cap / dipstick
13. Front wheel
14. Gear selector

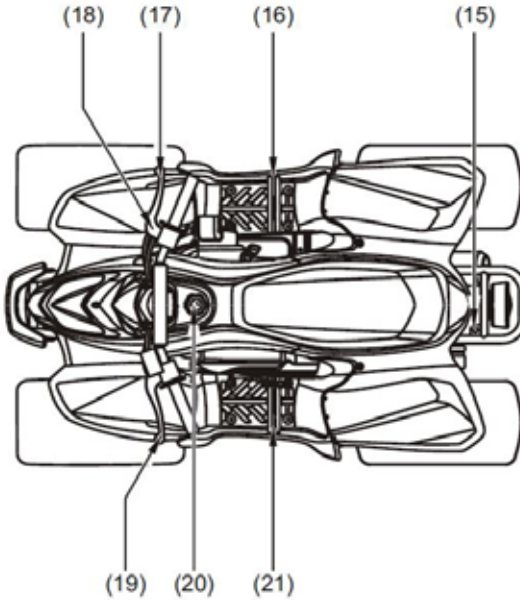

15. Flag pole bracket
16. Right footboard
17. Front brake lever
18. Parking brake
19. Rear brake lever
20. Fuel fill cap
21. Left footboard

Control Functions

Ignition Switch

Functions of the respective switch positions are as follows:

“OFF” position:

All electrical circuits are switched off. The key can be removed in this position.

“ON” position:

The taillight can be turned on.

With the engine stop switch at “RUN”, the engine can be started.

The key can not be removed.

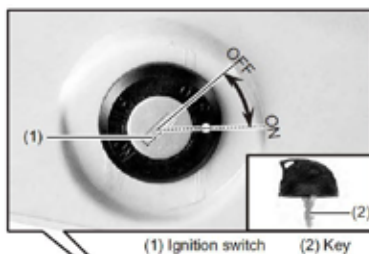

CAUTION

Always leave the ignition switch in the “OFF” position when the engine is not running. Leaving the ignition switch in the “ON” position when the engine is not running may cause the battery to discharge.

Handlebar Switches

(1) Engine stop switch

(2) Headlight switch

(3) Start switch

Engine Stop Switch

When the switch is at the “RUN” position, the engine will operate. When the switch is at the “OFF” position, the engine will not operate.

This switch is intended primarily as a safety or emergency control, and it should normally remain at the “RUN” position.

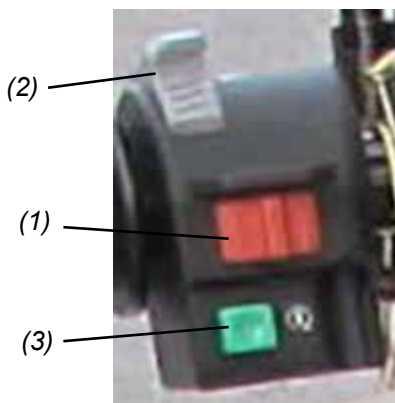



NOTE: If you stop your ATV by turning the engine stop switch to the “OFF” position, be sure to turn the ignition switch to the “OFF” position to prevent battery discharge.

Control Functions

Headlight Switch

The headlight switch has two position locations - low beam and high beam. The headlights will illuminate when turning the ignition key to the "ON" position..

"  " Low beam headlight

"  " High beam headlight

Starter Button

To start the engine, turn engine stop switch to the "RUN" position, turn ignition switch to the "ON" position and depress the starter button.



CAUTION

See starting instructions prior to starting engine (see page 28 for details).

NOTE: If the starter button is pushed with the ignition switch in the ON position and the engine stop switch in the OFF position, the starter motor will be activated but the engine will not start. To start the engine, be sure the engine stop switch is in the RUN position.

Kick Starter

The kick starter cranks the engine when the kick starter is operated.



CAUTION

See starting instructions prior to starting engine (see page 28 for details).

NOTE: If the kick starter is operated with the ignition switch in the ON position and the engine stop switch in the OFF position, the engine will not start. To start the engine, be sure the engine stop switch is in the RUN position.

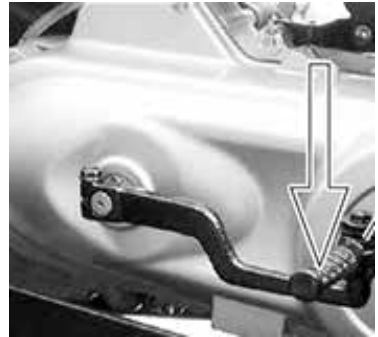

Remote Engine Stop Switch

The ATV has a remote engine stop switch. This allows the supervisor to follow close behind and stop the engine by pulling a tethered cord. Practice using it when your youngster first starts riding..

NOTE: Make sure the tethered cord lead is installed into the remote engine stop switch. When the tethered cord lead is not installed, the engine will not operate.



1. Remote engine stop switch
2. Tethered cord lead

Control Functions

Throttle Lever

Throttle lever is operated by the thumb. Pressing the lever opens the throttle. When pressure is released, spring tension automatically closes the throttle. Regulate the speed of the ATV by varying the throttle position.

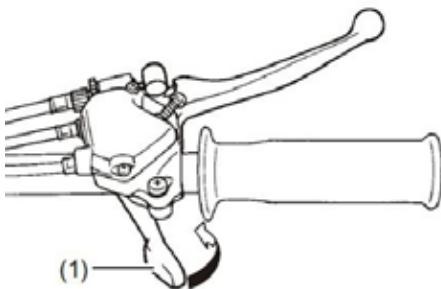

1. Throttle lever



WARNING

POTENTIAL HAZARD

Throttle malfunction.

WHAT CAN HAPPEN

The throttle could be hard to operate, making it difficult to speed up or slow down when you need to. This could cause an accident.

HOW TO AVOID THE HAZARD

Check the operation before you start the engine. If it does not work smoothly, check for the cause.

Correct the problem before riding the ATV.

Consult an authorized ARGO dealer if you can not locate or solve the issue yourself.

Speed Limiter

The speed limiter keeps the throttle from fully opening, even when the throttle lever is pushed to the maximum. Screwing IN the adjuster limits the maximum engine power available and decreases the maximum speed of the ATV.

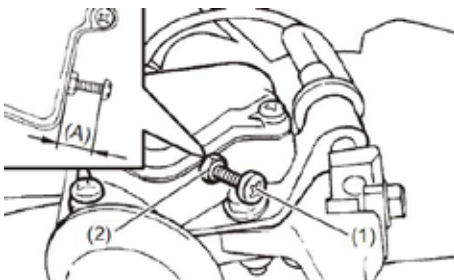

1. Adjuster
 2. Locknut
- (A). 0.72 in (18 mm)



WARNING

POTENTIAL HAZARD

Improper adjustment of the speed limiter and throttle.

WHAT CAN HAPPEN

The throttle cable could be damaged. Improper throttle operation could result causing you to lose control of the ATV and be injured or cause an accident.

HOW TO AVOID THE HAZARD

Do not turn the speed adjuster out more than 0.72 in. (18 mm). Always make sure the throttle lever free play is adjusted to 0.12-0.2 in. (3-5 mm).

Control Functions

Front Brake Lever

The front brakes are operated by squeezing the front brake lever.

1. Front brake lever

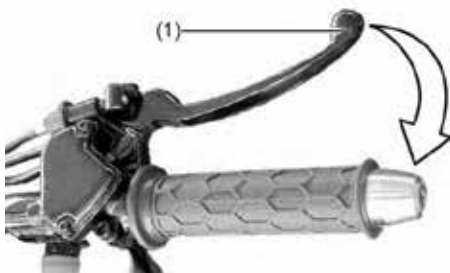

Rear Brake Lever

The rear brakes are operated by squeezing the rear brake lever.

1. Rear brake lever



Parking Brake Lever Lock

To set the parking brake, squeeze the front brake lever and lock it with the lock pin. Always set the parking brake when parking and before starting the engine.

To unlock the parking brake, squeeze the front brake lever until the lock pin releases.

Using the parking brake in freezing temperatures may cause the brakes to freeze in the locked position. See page 57.



1. Lock pin



WARNING

POTENTIAL HAZARD

Improper use of the parking brake.

WHAT CAN HAPPEN

The ATV could start to move unexpectedly if the parking brake is not applied before starting the engine. This could cause loss of control or a collision.

The brake could overheat if you ride the ATV before releasing the parking brake lever lock. You could lose braking performance which could cause an accident. You can also wear out the brakes prematurely.

HOW TO AVOID THE HAZARD

Always set the parking brake before starting the engine.

Always be sure you have released the parking brake lever lock before you begin to ride.

Control Functions

Fuel Tank Cap

After refueling, be sure to tighten the fuel tank cap. To refuel, refer to page 45.



Fuel Valve

The fuel valve supplies fuel from the fuel tank to the carburetor.

The fuel valve has three positions:

OFF: With the fuel lever pointing towards the left, fuel will not flow. Always turn the lever to this position when the engine is not running.

ON: With the fuel lever pointing down, fuel will flow to the carburetor. Normal riding is done with the lever in the down position.

RES: This indicates reserve. If you run out of fuel while riding, turn the fuel lever to point up. THEN FILL THE FUEL TANK AT THE FIRST OPPORTUNITY. After refueling, return the fuel valve lever to the ON (down) position.

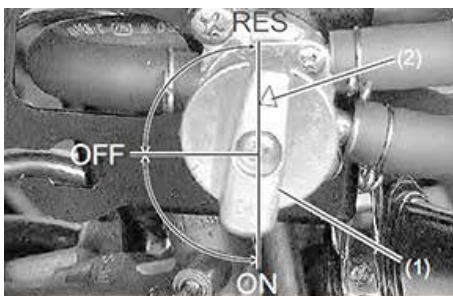

1. Fuel lever
2. Pointer mark

NOTE: After refueling, do not operate the ATV with the fuel valve in the RES (up) position. If you run out of fuel, there will be no reserve fuel supply.

Flag Pole Bracket

To mount a flag pole into the bracket.

NOTE: Flag poles are required in some riding areas. Check local regulations before riding.

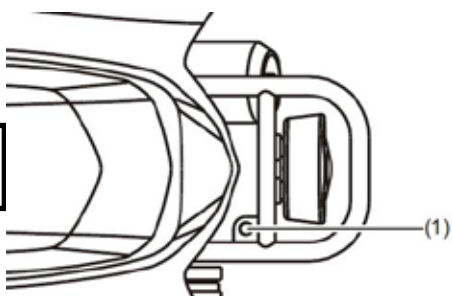

1. Flag pole bracket

Control Functions

Gear Selector

F = Forward gear

N = Neutral gear

R = Reverse gear

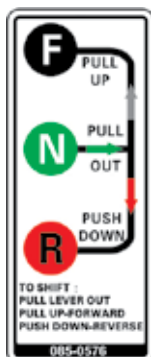

Gear selector



WARNING

To change gears, stop the ATV and, with the engine idling, move the gear selector lever to the desired gear.

Do not attempt to shift gears with the engine speed above idle or while the ATV is moving.

Shifting the Transmission

1. To shift into forward gear, pull out and upward on the gear selector lever until the transmission engages in the forward gear.



2. To shift into reverse gear, pull out and push downward on the gear selector lever until the transmission engages the reverse gear when the ignition switch is in the "ON" position, the reverse indicator light will illuminate.



Control Functions

3. To shift into neutral from either forward or reverse gear, push or pull the gear selector lever to the center position.
4. When in the neutral position with the ignition switch in the "ON" position, the neutral indicator light will illuminate.



WARNING

Always come to a complete stop with engine at idle before moving the shift lever. Changing gears while moving or shifting from neutral with the engine above idle could cause sudden change of direction result in loss of control or being thrown from the ATV causing severe injury or death.

Seat Removal

To remove the seat, pull upward on the seat lock lever and pull up the seat at the rear of the ATV.

1. Seat lock lever

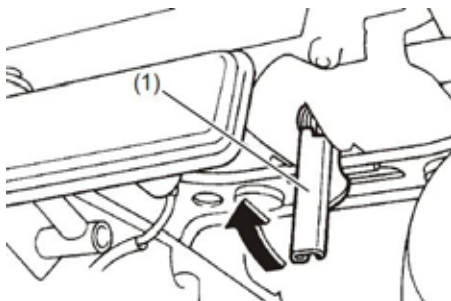

Seat Installation

To install the seat, align the tabs on the seat with the grommets on the frame and press the seat down until it locks into place.

NOTE: Ensure the seat is properly fitted into position and locked.



Control Functions

Storage Compartment

The storage compartment is located under the seat. To remove the seat, see page 33.

Be careful not to flood this area when washing your ATV or riding through water, and never put any electric conduction material in the storage compartment.



Tool Kit

A tool kit is provided with your ATV. It is recommended to put the tool kit in the vinyl bag and always carry them in the storage compartment under the seat.



1. Tool Kit 2. Rubber band



1. Air pressure gauge
2. Spark plug wrench
3. 10/12 mm wrench
4. Standard/Phillips screwdriver
5. Screwdriver handle
6. Tool bag
7. Rubber band

SECTION 5

Getting to Know Your ATV

Getting To Know Your ATV

This ATV is for recreation use. This section, riding your ATV, provides general ATV riding instructions for recreational riding. The skills and techniques described in this section, however, are appropriate for all types of riding. Riding your ATV requires special skills acquired through practice over a period of time. Take the time to learn the basic techniques well before attempting more difficult maneuvers.

Riding your new ATV can be a very enjoyable activity, providing you with hours of pleasure. But it is essential to familiarize yourself with the operation of the ATV to achieve the skill necessary to enjoy riding safely. Before you begin to ride, be sure you have read this Owner's Manual completely and understand the operation of the controls. Pay particular attention to the safety information and special safety message on pages 2-21. Please also read all caution and warning labels on your ATV.

Before Riding

Before allowing your youngster to ride the ATV, read "Important Message To Parents" (beginning on page 7) carefully and decide whether your youngster is ready to ride. You need to prepare before riding. This includes getting proper instruction, making sure your ATV is in good operating condition, and learning some basic safe-riding rules.

Rider Preparation - Age Recommendation

The minimum recommended age for this ATV model is 12. For safety, never let children under 12 years old operate this vehicle. Children under 16 should be supervised by an adult.

Pre-operation Checks

Always inspect your ATV each time you use it to make sure the ATV is in safe operating condition. Perform the pre-operation checks listed in this manual. Always follow the inspection and maintenance procedures and schedules described in the Owner's Manual.

Safe Riding Rules

Please note that the safe Riding Rules apply to all ATV riders. Even if you are an experienced rider, or after you become one continue to follow these guidelines for your own safety and enjoyment.

Protective Apparel

Always wear an approved motorcycle helmet when riding your ATV. You should also always wear goggles or a face shield, gloves, boots, a long-sleeved shirt or jacket, and long pants.

Getting To Know Your ATV

Weight Limits

This ATV is not designed to carry cargo or tow a trailer. Do not add a cargo rack or a trailer hitch.

There are limits to how much weight can be carried on your ATV. The following weight limit applies to standard equipment only. Modifying your ATV, using non-standard equipment or riding on terrain that is not flat and smooth could further reduce these limits.

Maximum weight capacity: 187 lb (85 kg)
(Including weight of operator, cargo and accessories).

Accessories

Genuine ARGO accessories have been specifically designed for and tested on this vehicle. Because ARGO cannot test all other accessories, you are personally responsible for properly selecting, installing, and using non- ARGO accessories.

1. Carefully inspect the accessory to make sure it does not block any lights, reduce ground clearance, or limit suspension travel, steering travel, or other controls.
2. Make sure the accessory does not interfere with your ability to shift body position on the seat or operate hand and foot controls.
3. Do not add electrical equipment that will exceed the vehicle's electrical system capacity. A blown fuse could cause a loss of lights or engine power.

No Modifications

Modifying this ATV or removing original equipment may render the vehicle unsafe or illegal. Spark arresters and mufflers are required in most areas. Don't modify your exhaust system or emission control system components. Remember, excessive noise bothers everyone and creates a bad image for off-road vehicles.

For Off-Road Use Only

This ATV is designed and manufactured for off-road use only.

Do not ride in areas posted "no-trespassing". Do not ride on private property without getting permission.

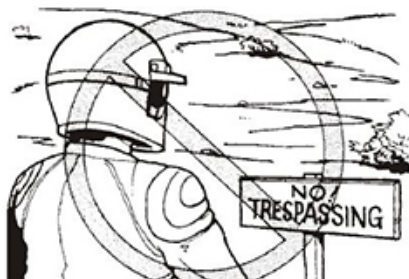

Ride Only When Visibility Is Good

Your ATV is equipped with a headlight. You should ride only when visibility is good.

Getting To Know Your ATV

Remote Engine Stop Switch For New Riders

The ATV has a remote engine stop switch (tethered cord). This allows the supervisor to follow close behind and stop the engine by pulling a tethered cord. Practice using it when your youngster first starts riding.

Once your youngster has completed the necessary training to safely operate the ATV, attach the tethered cord securely to the operator.



Braking

Practice starting and stopping at slow speeds. Gradually work up to faster starts and stops.

1. Steer straight ahead. Close the throttle completely, remove your thumb from the throttle lever.
2. Gently apply the brakes: pull both hand levers.

Gradually increase the lever pressure as you feel the brakes slowing your speed. The pressure used depends on your speed and the condition of the terrain you are riding. Slick, slippery or muddy ground requires gentler braking.

Pulling one or both brake levers too hard may cause the front and/or rear wheels to skid or slide out of control. If this happens, release all pressure on the lever immediately. Steer straight ahead to regain control. Then gently reapply the brakes.

Independent use of only the front or rear brakes reduces stopping performance. Extreme braking may cause the wheels to lock, reducing control of the ATV.

When possible, reduce speed or brake before entering a turn. Closing the throttle or braking in mid-turn may cause wheel slippage which will reduce control of your ATV.

Sliding or Skidding

Care should be used when riding on loose or slippery surfaces since the ATV may slide. If unexpected and uncorrected, sliding could lead to an accident.

To reduce the tendency for the front wheels to slide in loose or slippery conditions, positioning your weight over the front wheels will sometimes help.



Getting To Know Your ATV

Sliding or Skidding (continued)

If the rear wheels of your ATV start to slide sideways, control can usually be regained (if there is room to do so) by steering in the direction of the slide. Applying the brakes or accelerating is not recommended until you have corrected the slide.



With practice, over a period of time, skill at controlled sliding can be developed.

The terrain should be chosen carefully before attempting such maneuvers, since both stability and control are reduced. Bear in mind that sliding maneuvers should always be avoided on extremely slippery surfaces such as ice, since all control may be lost.

Turning Your ATV

To achieve maximum traction while riding off-road, the two rear wheels are mounted solidly on one axle and turn together at the same speed. Therefore, unless the wheel on the inside of the turn is allowed to slip or lose some traction, the ATV will resist turning. A special turning technique must be used to allow the ATV to make turns quickly and easily. It is essential that this skill be learned first at low speed.

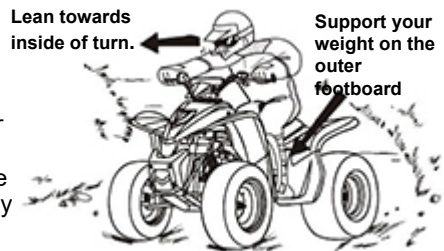

As you approach a curve, slow down and begin to turn the handlebars in the desired direction. As you do so, put your weight on the footboard to the outside of the turn (opposite your desired direction) and lean your upper body into the turn. Use the throttle to maintain an even speed through the turn. This maneuver will let the wheel on the inside of the turn slip slightly, allowing the ATV to make the turn properly.

This procedure should be practiced at slow speed many times in a large off-road area with no obstacles. If an incorrect technique is used, your ATV may continue to go straight. If the ATV doesn't turn, come to a stop and then practice the procedure again. If the riding surface is slippery or loose, it may help to position more of your weight over the front wheels by moving forward on the seat.

Once you have learned this technique you should be able to perform it at higher speeds or in tighter curves.

Improper riding procedures such as abrupt throttle changes, or too much speed for the sharpness of the turn may cause the ATV to tip. It may also be necessary to lean to the inside of the turn to avoid tipping over.

Remember: Avoid higher speeds until you are thoroughly familiar with the operation of your ATV.

Getting To Know Your ATV

Climbing Uphill

Use proper riding techniques to avoid vehicle overturns on hills. Be sure that you can maneuver your ATV well on flat ground before attempting any incline and then practice riding first on gentle slopes. Try more difficult climbs only after you have developed your skill. In all cases avoid inclines with slippery or loose surfaces, or obstacles that might cause you to lose control.

It is important when climbing a hill to make sure that your weight is transferred forward on the ATV. This can be accomplished by leaning forward and, on steeper inclines, standing on the footboards and leaning forward over the handlebars.

If you are climbing a hill and you find that you have not properly judged your ability to make it to the top, you should turn the ATV around while you still have forward motion (provided you have the room to do so) and go down the hill.

If your ATV has stalled or stopped and you believe you can continue up the hill, restart carefully to make sure you do not lift the front wheels which could cause you to lose control. If you are unable to continue up the hill, dismount the ATV on the uphill side. Physically turn the ATV around and then descend the hill.

If you start to roll backwards, **DO NOT** use the rear brake to stop. The ATV could easily tip over backwards. Instead, dismount the ATV immediately on the uphill side.

If the hill is not too steep and you have good footing, you may be able to walk the ATV back down the hill. Make sure your intended path is clear in case you lose control of the ATV. If you decide you can walk the ATV safely:

1. Stand with your body facing downhill, beside the vehicle so you can reach the rear brake lever with your left hand.
2. Be sure your legs are clear of the wheels.
3. Check your footing.
4. Then slowly and carefully back the ATV down the hill using the front brake lever to control speed.
5. If you lose control of the ATV, for your safety, get away from the vehicle.



If the hill is too steep or too slippery, or if you have any doubt whether you can safely walk the ATV back down the hill, leave the vehicle where it is and get help. If possible, block the wheels so the vehicle won't roll backwards.



Getting To Know Your ATV

Riding Downhill

When riding your ATV downhill, shift your weight as far to the rear and uphill side of the ATV as possible. Move back on the seat and sit with your arms straight. Improper braking may cause a loss of traction.

Use caution while descending a hill with loose or slippery surfaces. Braking ability and traction may be adversely affected by these surfaces.

Improper braking may also cause a loss of traction. Whenever possible, ride your ATV straight downhill. Avoid sharp angles which could allow the ATV to tip or roll over. Carefully choose your path and ride no faster than you will be able to react to obstacles which may appear.

Crossing A Slope

Traversing a sloping surface on your ATV requires you to properly position your weight to maintain proper balance. Be sure that you have learned the basic riding skills on flat ground before attempting to cross a sloping surface. Avoid slopes with slippery surfaces or rough terrain that may upset your balance.

As you travel across a slope, lean your body in the uphill direction. It may be necessary to correct the steering when riding on loose surfaces by pointing the front wheels slightly uphill. When riding on slopes be sure not to make sharp turns either up or down hill.

If your ATV does begin to tip over, gradually steer in the downhill direction if there are no obstacles in your path. As you regain proper balance, gradually steer again in the direction you wish to travel.

Riding Over Rough Terrain

Riding over rough terrain should be done with caution. Look out for obstacles which could cause damage to the ATV or could lead to an accident. Be sure to keep your feet firmly mounted on the footboards at all time. Avoid jumping the ATV as loss of control and damage to the ATV may result.

Crossing Through Shallow Water

The ATV can be used to cross slow moving, shallow water up to the running boards. Before entering the water, choose your path carefully. Enter where there is no sharp drop off, and avoid rocks or other obstacles which may be slippery or upset the ATV. Drive slowly and carefully.



Test your brakes after leaving the water. Do not continue to ride your ATV without verifying that you have regained proper braking ability.

Parking

Always choose a level place to park. After bringing your ATV to a stop, hold the brakes while you shift into neutral. Then set the parking brake and turn the ignition switch OFF. If you're through parking for the day, also turn the fuel valve OFF.

Getting To Know Your ATV

WHAT TO DO IF

This section is designed to be a reference guide only. Be sure to read each section on riding techniques completely.

WHAT TO DO....

If your ATV doesn't turn when you want it to:

Bring the ATV to a stop and practice the turning maneuvers again. Be sure you are putting your weight on the footboard to the outside of the turn. Position your weight over the front wheels for better control.

If your ATV begins to tip while turning:

Lean more into the turn to regain balance. If necessary, gradually let off the throttle and /or steer to the outside of the turn.

If your ATV starts to slide sideways:

Steer in the direction of the slide if you have the room.

Applying the brakes or accelerating is not recommended until you have corrected the slide.

If your ATV can't make it up a hill you are trying to climb:

Turn the ATV around if you still have forward speed. If not, stop, dismount on the uphill side of the ATV and physically turn the ATV around. If the ATV starts to slip backwards DO NOT USE THE REAR BRAKE - the ATV may tip over on top of you. Dismount the ATV on the uphill side.

If your ATV is traversing a sloping surface:

Be sure to ride with your weight positioned towards the uphill side of the ATV to maintain proper balance. If the ATV starts to tip, steer down the hill (if there are no obstacles in your way) to regain balance. If you discover that the ATV is going to tip over, dismount on the uphill side.

If your ATV encounters shallow water:

Ride slowly and carefully through slow moving water, watching for obstacles. Be sure to let water drain from the ATV and CHECK YOUR BRAKES FOR PROPER OPERATION when you come out of the water. Do not continue to ride your ATV until you have regained adequate braking ability.

SECTION 6

Before You Ride

Engine Break-In

There is never a more important period in the life of your ATV than the period between 0 and 20 hours.

For this reason, we ask that you carefully read the following material. Because the engine is brand new, you must not put an excessive load on it for the first 20 hours, the various parts in the engine wear and polish themselves to the correct operating clearances.

During this period, prolonged full throttle operation or any condition which might result in excessive engine heating must be avoided. However, momentary (2~3 seconds maximum) full throttle operation under load does not harm the engine. Each full throttle acceleration sequence should be followed with a substantial rest period for the engine by cruising at lower rpm so the engine can rid itself of the temporary build up of heat.

If any abnormality is noticed during this period, consult an authorized ARGO dealer.

1. 0 - 10 hours:

Avoid continuous operation above half throttle. Allow a cooling off period of five to ten minutes after every hour of operation. Vary the speed of the machine from time to time. Do not operate it at full throttle position.

2. 10 - 20 hours:

Avoid prolonged operation above 3/4 throttle. Rev the machine freely through the gears but do not use full throttle at any time.

3. After break-in:

Avoid prolonged full throttle operation. Vary speeds occasionally.

Pre-Operation Checks

Inspect your vehicle each time you use it to make sure the vehicle is in safe operating condition.

Always follow the inspection and maintenance procedures and schedules described in your Owner's Manual.



WARNING

Failure to inspect or maintain the vehicle properly increase the possibility of accident or equipment damage. Do not operate the vehicle if you find any problem. If a problem cannot be corrected by the procedures provided in this manual, have the vehicle inspected by the dealer.

Operation - Before You Ride

Before operating this ATV, check the following points:

ITEM	ROUTINE
Fuel	<ul style="list-style-type: none">• Check fuel level in fuel tank and add recommended fuel if necessary.• Check fuel line for leakage. Correct if necessary.
Engine Oil	<ul style="list-style-type: none">• Check oil level in engine and add recommended oil to specified level if necessary.• Check ATV for oil leakage. Correct if necessary.
Final Gear Oil	<ul style="list-style-type: none">• Check ATV for oil leakage. Correct if necessary.
Front Brake	<ul style="list-style-type: none">• Check operation, if soft or spongy, have the dealer bleed the hydraulic system.• Check brake pads for wear and replace if necessary.• Check brake fluid level in reservoir and add recommended brake fluid to specified level if necessary.• Check hydraulic system for leakage. Correct if necessary.
Rear Brake	<ul style="list-style-type: none">• Check operation and correct if necessary.• Lubricate cables if necessary.• Check lever free play and adjust if necessary.
Throttle Lever	<ul style="list-style-type: none">• Ensure smooth operation. Lubricate cable and lever housing if necessary.• Check lever free play and adjust if necessary.
Control Cables	<ul style="list-style-type: none">• Ensure smooth operation. Lubricate if necessary.
Wheels and Tires	<ul style="list-style-type: none">• Check wheel condition and replace if damaged.• Check tire condition and tread depth. Replace if necessary.• Check air pressure. Correct if necessary.
Brake Levers	<ul style="list-style-type: none">• Ensure smooth operation. Lubricate lever pivoting point if necessary.
Chassis Fasteners	<ul style="list-style-type: none">• Ensure all nuts, bolts and screws are properly secured.
Instruments, Lights and Switches	<ul style="list-style-type: none">• Check operation and correct if necessary.

Operation - Before You Ride

Front and Rear Brakes

1. Drum Brake

Check for correct free play in the brake levers. If the free play is incorrect, adjustment is needed. (See page 66).

Check operation of the levers. They should move smoothly and there should be a firm feeling when the brake is applied. If not, have the ATV inspected by an authorized ARGO dealer.

2. Disk Brake

Make sure there is no brake fluid leakage.

Check operation of the levers. They should move smoothly and there should be a firm feeling when the brake is applied. If not, have the ATV inspected by an authorized ARGO dealer.

3. Brake operation

Test the brakes at slow speed after starting out to make sure they are working properly. If the brakes do not provide proper braking performance, inspect the brakes for wear. (See page 65-66)



WARNING

POTENTIAL HAZARD

Riding with improperly operating brakes.

WHAT CAN HAPPEN

You could lose braking ability, which could lead to an accident.

HOW TO AVOID THE HAZARD

Always check the brakes at the start of every ride. Do not ride the ATV if you find any problem with the brakes. If a problem cannot be corrected by the adjustment procedures provided in this manual, have the ATV inspected by an authorized ARGO dealer.

Fuel

Fill the fuel tank when necessary and make sure there is sufficient gasoline in the tank.

Check for leaks.

Fuel level should be below the filler neck.

1. Filler neck

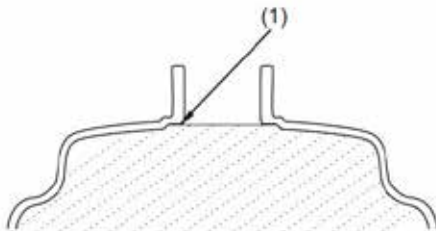

Recommended Fuel

Unleaded

Fuel Tank Capacity:

Total - 1.4 gal (5.5 L)

Reserve - 0.38 gal (1.5 L)

Operation - Before You Ride

Your ARGO engine has been designed to use regular unleaded gasoline with a pump octane number of 86 or higher. If knocking or pinging occurs, use a different brand of gasoline or premium unleaded fuel. Unleaded fuel will give you longer spark plug life and reduced maintenance cost.

Use unleaded fuel only because it produces fewer engine and spark plug deposits and extends the life of the exhaust system. Never use stale or contaminated gasoline or an oil/gasoline mixture. Avoid getting dirt, dust or water in the fuel tank.



WARNING

POTENTIAL HAZARD

Improper care when refueling.

WHAT CAN HAPPEN

Fuel can spill, which can cause a fire and severe injury.

HOW TO AVOID THE HAZARD

Do not overfill the fuel tank. Be careful not to spill fuel, especially on the engine or exhaust pipe. Wipe up any spilled fuel immediately. Be sure the fuel tank cap is closed securely. Do not refuel immediately after the engine has been running and is still very hot.

Engine and Transmission Oil

Make sure the engine and transmission oil are at the specified level. Add oil as necessary. (See page 61).

Check for any leaks.

Recommended engine / transmission oil classification: API Service SE, SF, SG type or higher.



CAUTION

Be sure to use motor oils that do not contain anti-friction modifiers. Passenger car motor oils (often labeled "Energy Conserving") contain anti-friction additives which will cause starter clutch slipping, resulting in reduced component life and poor engine performance.

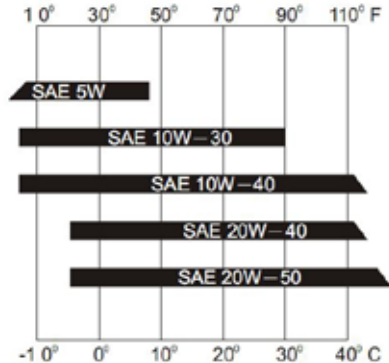

Oil Capacity

Engine Oil:

Total Amount:
0.84 qt. (0.8 L)

Periodic oil change:
0.74 qt. (0.7 L)

Transmission Oil:

Total Amount:
0.13 qt. (0.12 L)

Periodic oil change:
0.12 qt. (0.11 L)

Operation - Before You Ride

Chain

Check the general condition of the chain and check the chain slack before every ride. Lubricate and adjust the chain as necessary. (See page 68).

Throttle Lever

Check to see that the throttle lever operates correctly. Throttle must open smoothly and spring back to the idle position when released. Adjust as necessary for proper operation.

Fittings and Fasteners

Always check chassis fittings and fasteners to ensure they are tight and secure. Take the ATV to an authorized ARGO dealer or refer to the Service Manual for correct torque specifications.

Lights

Check the headlight and taillight to ensure they are in proper operating condition. Repair as necessary for proper operation.

Switches

Check the operation of the headlight switch, engine stop switch and any other switches. Repair as necessary for proper operation.

Tires

1. The tires listed below have been approved by ARGO for this model. Other tire combinations are not recommended.
2. The tires should be set to the recommended tire pressure:
FRONT: 3.0 psi (0.21 kgf/cm², 20.6 kPa)
REAR: 3.0 psi (0.21 kgf/cm², 20.6 kPa)
Check and adjust tire pressures when the tires are cold.
Tire pressures must be equal on both sides.
3. Tire pressure below the minimum specified could cause the tire to dislodge from the rim under severe riding conditions.
4. Never set tire pressure over the recommended pressure.
Higher pressures may cause the tire to burst. Inflate the tires very slowly and carefully. Fast inflation could cause the tire to burst.

Operation - Before You Ride

How to Measure Tire Pressure

Use the low-pressure tire gauge found in the tool kit.

NOTE: The low-pressure tire gauge is included as standard equipment. Make two measurements of the tire pressure and use the second reading. Dust or dirt in the gauge could cause the first reading to be incorrect.



WARNING

POTENTIAL HAZARD

Operating this ATV with improper tires, or with improper or uneven tire pressure.

WHAT CAN HAPPEN

Use of improper tires on this ATV, or operation of this ATV with improper or uneven tire pressure, may cause loss of control, increasing the risk of an accident.

HOW TO AVOID THE HAZARD

Follow the recommended tire pressures above.

Set tire pressure to the following (tires cold):

	Recommended pressure
Front	3.0 psi (0.21 kgf/cm ² , 20.6 kPa)
Rear	3.0 psi (0.21 kgf/cm ² , 20.6 kPa)



1. Low-pressure tire gauge

Tire Wear Limit

When the tire groove decreases to 0.16 in (4 mm) due to wear, replace the tire.

A. 0.16 in (4 mm)

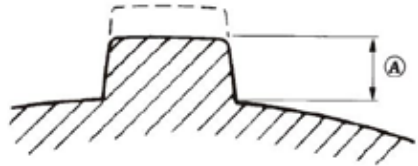

WARNING

POTENTIAL HAZARD

Operating this ATV without being familiar with all controls and functions.

WHAT CAN HAPPEN

Loss of control, increasing the risk of an accident or injury.

HOW TO AVOID THE HAZARD

Read the Owner's Manual carefully. If there is a control or function you do not understand, contact an authorized ARGO dealer.

Operation - Before You Ride

Starting a Cold Engine - Electric Starter

1. Select a level surface and lock the parking brake (see page 30) before starting the engine.
2. Turn the fuel lever to ON.
3. Turn the engine stop switch to the RUN position, turn the ignition switch to ON.
4. Ensure the tethered cord lead is installed into the remote engine stop switch.
5. With the throttle closed, depress the starter button. Release the starter button as soon as the engine starts.

NOTE: Do not use the electric starter for more than 5 seconds at a time. Release the starter button for approximately 10 seconds before pressing it again.

6. Continue warming up the engine until it idles smoothly before riding.



CAUTION

See the "Engine Break-In" section prior to operating engine for the first time.



WARNING

POTENTIAL HAZARD

Freezing control cables in cold weather.

WHAT CAN HAPPEN

Loss of control, increasing the risk of an accident or injury.

HOW TO AVOID THE HAZARD

When riding in cold weather, always make sure all controls and cables function properly before you begin riding.

Starting a Cold Engine - Without Electric Starter

1. Follow previous steps 1-4.
2. With the throttle closed, operate the kick starter with a rapid, continuous downward motion.



CAUTION

- Do not allow the kick starter to snap back freely against the pedal stop as engine case damage could result.
- Raise/fold the kick starter pedal after the kick starter lever is returned to the stop.

3. Follow previous step 6.

Operation - Before You Ride

Starting a Warm Engine

To start a warm engine, refer to the “Starting a Cold Engine” section.

Warming Up Engine

To get maximum engine life, always warm up the engine. Never accelerate hard with a cold engine! To see whether or not the engine is warm, check if it responds to the throttle normally.



CAUTION

- Do not operate the throttle (open and close rapidly) as the ATV will move forward suddenly, causing possible loss of control.
- Do not leave the ATV unattended while the engine is warming up.

Parking

When parking, stop the engine. Turn the fuel lever to the “OFF” position and apply the parking brake.

Make sure the lock pin is in the locked position.

To set the parking brake, see page 30.



1. Locked position

Parking on a Slope

1. Bring the ATV to a complete stop by applying the brakes.
2. Stop the engine.
3. With the rear brake applied, apply the parking brake.



WARNING

POTENTIAL HAZARD

Parking on a hill or other incline.

WHAT CAN HAPPEN

ATV could roll out of control, increasing the risk of an accident or injury.

HOW TO AVOID THE HAZARD

Whenever possible, avoid parking on hills or other inclines. If you must park on an incline, apply the parking brake, and block the front and rear wheels with rocks or other objects. Do not park the ATV at all on hills that are so steep you could not walk up them easily.

SECTION 7

Operation

Always wear the following to reduce risk of injury in an accident:

- Approved motorcycle helmet that fits properly.
- Eye protection (goggles, helmet face shield or protective eyewear)
- Over the ankle boots, gloves, long sleeved shirt or jacket and long pants.

An approved helmet and other personal protective equipment can reduce the severity of injuries in an accident.



WARNING

Operating without an approved motorcycle helmet increases your chances of a severe head injury or death in the event of an accident.

Wear eye protection when operating your ATV to reduce the risk of a serious accident or injury. Eye protection such as a face shield or goggles may reduce the risk of foreign material getting in your eyes and help prevent loss of vision.



WARNING

Operating without eye protection can result in an accident and increases your chances of a severe injury in the event of an accident.

Mounting the ATV

1. From the left side, grasp the left-side handlebar, apply the left-side hand brake, and put your left foot on the footrest.
2. Grasp the right-side handlebar.
3. Swing your right leg over the seat and position your right foot on the right-side footrest.
4. Position yourself on the seat.
5. Always keep your feet positioned in the footrests and hands on the handlebars.

Starting the Engine

Always start the engine with the ATV on a flat, level surface. Always start your ATV outside as it produces Carbon Monoxide poisoning which will cause harm. Follow these steps to start your ATV:

1. Engage the brake lever lock on the left-side handlebar.
2. Turn the engine stop switch to "RUN" position.
3. Turn the fuel valve to the "ON" position.
4. Rotate the ignition switch key to the "ON" position.
5. Shift ATV into the "N" (Neutral) position.
6. Depress the starter button.
7. Allow the engine to properly warm up. Do not depress the throttle lever until the engine has reached operating temperature.



CAUTION

Do not run the starter motor for more than 8 (eight) seconds per starting attempt as the starter motor may overheat causing severe damage. Allow 15 (fifteen) seconds between starting attempts to allow the starter motor to cool.

Operation

8. Allow the engine to properly warm up. If the engine has not reached proper operating temperature, the spark plug may not have reached a high enough temperature to burn off the excess fuel in the combustion chamber.



CAUTION

If unburned fuel remains in the combustion chamber due to lack of run time, spark plug fouling may occur during the next starting attempt.

Emergency Starting the ATV

This ATV is equipped with an emergency kick starter function if the electric start function become inoperable. To use the kick starter function, follow the below procedure.



WARNING

Ensure the brake lever lock is engaged when using emergency kick starter.

1. Push down on kick starter until light resistance is felt, then with a short, rapid downward stroke, start engine.
2. Repeat until engine starts.
3. Once ATV is warmed up, depress the front brakes to release the brake lever lock.



Braking / Stopping

Always allow plenty of room and time to come to a easy, smooth stop. To come to a complete stop, you must:

1. To apply both the front and rear brakes, compress both left and right brake levers located on the handlebars.
2. If the wheels lock or skid, release the brake levers and apply again.
3. Never hold the brake and accelerate at the same time. This will cause the brake system to overheat.

Parking

Parking requires following the previous rules of braking; then:

1. When the ATV comes to a complete stop, shift ATV into the neutral "N" position.
2. Stop the engine using the engine stop switch located on the handlebar.
3. Turn the ignition switch to the "OFF" position.
4. Engage the brake lever lock.

NOTE: If parking on a hill or slope, shift the ATV into forward or reverse gear.

Turning Your ATV



WARNING

Always follow proper procedures for turning as described in this Owner's Manual. Practice turning at low speeds before attempting to turn at faster speeds. Do not turn at speeds too fast for your skills or the conditions. ATV could go out of control causing a collision or overturn.

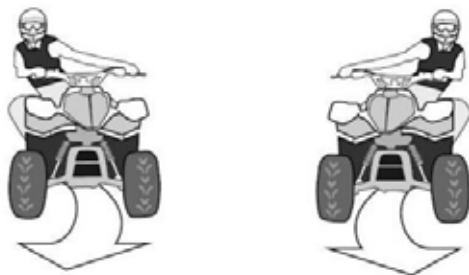

To achieve maximum traction while riding off-road, the two rear wheels turn together at the same speed. Therefore, unless the wheel on the inside of the turn is allowed to slip or lose some traction, the ATV will resist turning. A special turning technique must be used to allow the ATV to make turns quickly and easily. It is essential that this skill be learned first at low speed.

As you approach a curve, slow down and begin to turn the handlebars in the desired direction. As you do so, put your weight on the footboard to the outside of the turn (opposite your desired direction) and lean your upper body into the turn. Use the throttle to maintain an even speed through the turn. This maneuver will let the wheel on the inside of the turn slip slightly allowing the ATV to make the turn properly.

This procedure should be practiced at slow speed many times in a large off-road area with no obstacles. If an incorrect technique is used, your ATV may continue to go straight. If the ATV doesn't turn, come to a stop and then practice the procedure again. If the riding surface is slippery or loose, it may help to position more of your weight over the front wheels by moving forward on the seat.

Once you have learned this technique, you should be able to perform it at higher speeds or in tighter curves.

Improper riding procedures such as abrupt throttle changes, excessive braking, incorrect body movement or too much speed for the sharpness of the turn may cause the ATV to tip. If the ATV begins to tip over to the outside while negotiating a turn, lean more to the inside. It may also be necessary to gradually let off on the throttle and steer to the outside of the turn to avoid tipping over.

Remember: Avoid higher speeds until you are thoroughly familiar with the operation of your ATV.

Operation

Climbing Uphill



WARNING

Climbing hills improperly can cause overturns or loss of control. Use proper riding techniques described in this Owner's Manual.



Do not attempt to climb hills until you have mastered basic maneuvers on flat ground. Always check the terrain carefully before attempting any hill. In all cases avoid inclines with slippery or loose surfaces or obstacles that might cause you to lose control.

To climb a hill, you need traction, momentum and steady throttle.

Travel fast enough to maintain momentum but not so fast that you cannot react to changes in the terrain as you climb.

It is important when climbing a hill to make sure that your weight is transferred forward on the ATV. This can be accomplished by leaning forward and on steeper inclines, standing on the footboards and leaning forward over the handlebars.

Whenever possible, ride straight up hills.

Slow down when you reach the crest of the hill if you cannot see clearly what is on the other side there could be another person, an obstacle or a sharp drop off.

Use common sense and remember that some hills are too steep for you to climb or descend.

If you are climbing a hill and you find that you have not properly judged your ability to make it to the top, you should turn the ATV around while you still have forward motion and go down the hill.

If your ATV has stalled or stopped and you believe you can continue up the hill, restart carefully to make sure you do not lift the front wheels which could cause you to lose control. If you are unable to continue up the hill, dismount the ATV on the uphill side. Physically turn the ATV around and then descend the hill.

If you start to roll backwards, DO NOT apply either brake abruptly. Avoid sudden application of either the front or rear brake as the wheels on the uphill side could come off the ground. The ATV could easily tip over backwards. Apply both the front and rear brakes gradually. When fully stopped, apply the brake lever lock and dismount the ATV immediately on the uphill side or to a side if pointed straight uphill. Turn the ATV around and remount, following the procedure described in the Owner's Manual.



WARNING

Stalling, rolling backwards or improperly dismounting while climbing a hill could result in ATV overturning. If you cannot control the ATV, dismount immediately on the uphill side.

Operation

Riding Down Hill



WARNING

Going down a hill improperly could cause overturns or loss of control. Always follow proper procedures for going down hills as described in this Owner's Manual.

When riding your ATV downhill, shift your weight as far to the rear and uphill side of the ATV as possible. Move back on the seat and sit with your arms straight. Engine compression will do most of the braking for you.

Use caution while descending a hill with loose or slippery surfaces. Braking ability and traction may be adversely affected by these surfaces. Improper braking may also cause a loss of traction.



When descending hills, gradually apply both front and rear brakes as necessary. Avoid sudden application of either the front or rear brake because the wheels on the uphill side could come off the ground.

Whenever possible, ride your ATV straight downhill. Avoid sharp angles, which could allow the ATV to tip or roll over. Carefully choose your path and ride no faster than you will be able to react to obstacles, which may appear.

Crossing a Slope



WARNING

Improperly crossing hills or turning on hills could cause loss of control or cause the ATV to overturn.

Traversing a sloping surface on your ATV requires you to properly position your weight to maintain proper balance. Be sure that you have learned the basic riding skills on flat ground before attempting to cross a sloping surface. Avoid slopes with slippery surfaces or rough terrain that may upset your balance.

As you travel across a slope, lean your body in the uphill direction. It may be necessary to correct the steering when riding on loose surfaces by pointing the front wheels slightly uphill. When riding on slopes, be sure not to make sharp turns either up or down hill.

If your ATV does begin to tip over, gradually steer in the downhill direction if there are no obstacles in your path. As you regain proper balance, gradually steer again in the direction you wish to travel.



Operation

Crossing Through Shallow Water



WARNING

Operating this vehicle through deep or fast flowing water can lead to loss of control or an overturn. To reduce your risk of drowning or other injuries, use care when crossing through water. Never operate this ATV water deeper than the depth specified in your Owner's Manual, as tires may float, increasing the risk of an overturn.

The ATV can be used to cross slow moving, shallow water up to the bottom of the running boards. Before entering the water, choose your path carefully. Enter where there is no sharp drop off, and avoid rocks or other obstacles, which may be slippery or upset the ATV. Drive slowly and carefully.

Test your brakes after leaving the water. If necessary, apply them several times to let the friction dry out the linings. Do not continue to ride your ATV without verifying that you have regained proper braking ability.



WARNING

Wet brakes may have reduced stopping ability, which could cause loss of control.

After riding your ATV in water, be sure to drain the trapped water by removing the check hose at the bottom of the air filter case to drain any water that may have accumulated.



CAUTION

Un-drained water can cause damage or improper operation.

Riding Over Rough Terrain



WARNING

Riding improperly over obstacles could cause loss of control or a collision. Before operating in a new area, check for obstacles. Never attempt to ride over large obstacles, such as large rocks or fallen trees. When you go over obstacles, always follow proper procedures as described in the Owner's Manual.

Riding over rough terrain should be done with caution. Look out for obstacles, which could cause damage to the ATV or could lead to an upset or accident. Be sure to keep your feet firmly mounted on the footboards at all times. Avoid jumping the ATV as loss of control and damage to the ATV may result.

Operation

Sliding and Skidding



WARNING

Skidding or sliding improperly may cause you to lose control of this ATV. You may also regain traction unexpectedly, which may cause the ATV to overturn.

Care should be used when riding on loose or slippery surfaces since the ATV may slide. If unexpected and uncorrected, sliding could lead to an accident.

To reduce the tendency for the front wheels to slide in loose or slippery conditions, positioning your weight over the front wheels will sometimes help.

If the rear wheels of your ATV start to slide sideways, control can usually be regained by steering in direction of the slide. Applying the brakes or accelerating is not recommended until you have corrected the slide.

With practice, over a period of time, skill at controlled sliding can be developed. The terrain should be chosen carefully before attempting such maneuvers since both stability and control are reduced.

Bear in mind that sliding maneuvers should always be avoided on extremely slippery surfaces, such as ice, since all control may be lost.

Crossing Roads

Use extreme caution while crossing a road, avoid if at all possible. If you must cross a road:

1. Stop completely before crossing a road.
2. Check both directions for oncoming traffic.
3. NEVER attempt to cross a road or intersection at a blind crossing.
4. Drive straight across to the opposite side.
5. Allow plenty of time to safely cross the road.
6. Know your state and local laws. It is illegal to cross public roads in some places.

Cold Weather Operation

NOTE: Ensure all control levers operate as intended. Make sure the footrests are free and clear of ice and snow.



WARNING

For your personal safety, it is important to wear the proper type and amount of cold-weather clothing according to the coldest anticipated temperatures.

1. With the brake lever lock released, move the ATV forward and backward to ensure the wheels roll freely. If the ATV does not move, the tires may be frozen to the ground or the brake shoes may be frozen to the drums.
2. If the tires are frozen to the ground, pour warm water around them to melt any ice around the tires.



CAUTION

Before operating, manually move the ATV forward and backward to ensure the wheels roll freely.

Operation

3. If the brakes are frozen, move the ATV to a warm location to thaw out the brakes.



WARNING

For your personal safety, do not attempt to free frozen brakes by pouring warm water on the brakes.

NOTE: After the brakes have thawed, dry them by compressing the brake lever several times while riding slowly.

NOTE: After riding through snow, slush, water or mud, it is recommended to dry the brake system before parking the ATV.



WARNING

For your personal safety, go slow and be extra careful while riding on snow or ice-covered terrain. Always be alert to the changing terrain while operating the ATV.

4. Practice driving in an open snow or ice-covered area at slow speeds.
5. Learn how the ATV responds to steering and braking on snow or ice-covered terrain.

Stopping the ATV

To stop the ATV, release the throttle lever and gradually apply both the front and rear brakes.

Stopping the Engine

To stop the engine, slide the engine stop switch to the “OFF” position or turn the ignition switch key to the “OFF” position. If you are through riding for the day, turn the fuel valve to the “OFF” position.

NOTE: If you stop your ATV by turning the engine stop switch to the “OFF” position, be sure to turn the ignition switch to the “OFF” position to prevent battery discharge.

SECTION 8

General Maintenance

NOTE: Proper maintenance of the ATV is extremely important for the safe operation and optimum performance. Follow the Maintenance Schedule and all ensuing maintenance instructions/information.

Inspection, adjustment and lubrication will keep your vehicle in the safest and most efficient condition possible.

Safety is an obligation of the vehicle owner/operator.



WARNING

Failure to properly maintain the vehicle may increase your risk of injury or death during service or while using the vehicle. If you are not familiar with vehicle service, have a dealer perform the service.



WARNING

Turn off the engine when performing maintenance unless otherwise specified.

- A running engine has moving parts that can catch on body parts or clothing and electrical parts that can cause shocks or fires.
- Running the engine while servicing can lead to eye injury, burns, fire or carbon monoxide poisoning or death.



WARNING

Brake discs, calipers, drums and linings can become very hot during use. To avoid possible burns, let brake components cool before touching them.

The intervals given in the scheduled maintenance charts should apply to normal riding conditions. However, **depending on the weather, terrain, geographical location and individual use, the maintenance intervals may need to be shortened.**

You may choose any qualified repair shop or person to maintain, replace, or repair emission control devices and systems with original or equivalent replacement parts. However, warranty, recall and all other services paid for by Argo USA must be performed at an authorized Argo USA service center which will complete repairs in a reasonable amount of time. Argo USA service centers can provide all manner of service.

Ensure the service book is stamped and signed. Failure to do so could invalidate your warranty.

The maintenance schedule is based on months of use or kilometers/miles traveled, whichever comes first.

Maintenance Schedule						
Item		INITIAL			EVERY	
		1 month	2 months	3 months	3 months	1 year
Air Filter	Clean. Replace if necessary.		X	X	X	X
Brake System	Check operation. Adjust if necessary.	X	X	X	X	X
Carburetor	Check idle speed / starter operation. Adjust if necessary.		X	X	X	X
Drive Belt	Check operation. Replace if damage or excessive wear.	X				X
Engine Oil	Replace (Warm engine before draining).	X		X	X	X
Engine Oil Filter Screen	Clean. Replace if necessary.	X				X
Fitting / Fasteners	Check all chassis fittings and fasteners. Collect if necessary.	X	X	X	X	X
Fuel Line	Check fuel hoses for cracks or damage. Replace if necessary.			X	X	X
Knuckle shafts	Lubricate every 6 months.			X	X	X
Spark Plug	Check condition. Clean or replace if necessary.	X	X	X	X	X
Steering system	Check operation. Replace if damage. Check toe-in. Adjust if necessary.	X	X	X	X	X
Transmission Oil	Check for oil leakage. Replace every 12 months.	X				X
Valves	Check valve clearance. Adjust if necessary	X		X	X	X
Wheels	Check balance / damage / runout. Replace if necessary.	X		X	X	X
Wheel Bearings	Check bearings assembly for operation / damage. Replace if damaged.	X		X	X	X

Dusty or wet conditions require smaller maintenance intervals.

General Maintenance

Engine Oil - Checking

Check engine oil level. The engine should always be warm.

1. Park the ATV on level ground.

NOTE: Wait a few minutes until the oil settles before checking oil level.

2. Remove the oil level stick and wipe it off with a clean cloth.
3. Insert the oil level stick into the filler hole without screwing it in.
4. Remove the oil level stick and inspect the oil level.
5. The oil level should be between the minimum and maximum marks. If the level is low, add oil to the proper level.
6. Reinstall oil level stick and tighten securely.

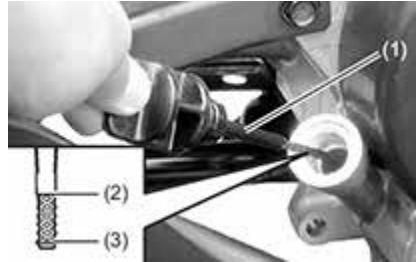

1. Oil level stick . oil filler cap
2. Maximum level mark
3. Minimum level mark



CAUTION

Ensure no foreign material enters the crankcase.

Engine Oil - Change Oil Filter Cleaning

Recommended Engine Oil - API Service SE,
SF, SG type or higher
Oil quantity: 0.74 qt (0.7 L)

Change the engine oil at the scheduled intervals. The engine should always be warm so the oil will drain easily and completely.

1. Park the ATV on level ground.
2. Place a suitable container under the ATV.
3. Remove the oil drain plug from the left side of the engine; then remove the oil screen/filter cap from under the right-front of the engine and clean the screen.



1. Oil filter cap

1. Oil drain plug



CAUTION

Ensure no foreign material enters the crankcase.

When removing the drain plug, the compression spring, oil strainer and O-ring will fall out. Be careful not to lose these items.

General Maintenance

Engine Oil - Change / Oil Filter Cleaning (continued)

4. Clean the oil strainer with solvent.
5. Inspect the O-ring and replace if damaged.
6. Reinstall the O-ring, oil strainer, compression spring and tighten to 11 ft-lb.
7. Install the drain plug and tighten to 22 ft-lb. Pour the recommended oil in the fill hole. Install oil level stick and secure.
8. Start the engine (while the ATV is on level ground and outside any building) and allow to idle for 3-4 minutes. Check for oil leakage while warming up ATV.
9. Shut the engine off; then allow oil to drain into the crankcase for approximately 3-5 minutes. Remove the oil level stick and check for proper oil level.

Transmission Oil - Checking

Check transmission oil level. The engine should always be warm.

1. Park the ATV on level ground.
2. Remove the two right cover bolts and remove the cover.
3. Remove the check bolt (C) using a 12 mm socket. The final drive oil should be visible in the hole.
4. If the oil level is not visible or below the oil level bolt hole, add more final drive oil through the filler bolt (F) until final drive oil begins to run out the check bolt (C).
5. Install the check and filler bolts with new sealing washers. Tighten to 13 ft lb (18 N-m).

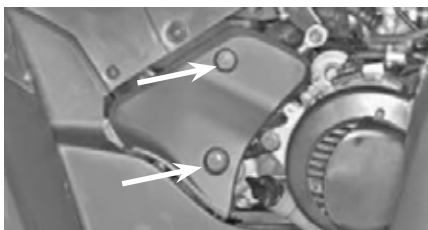

Transmission Oil - Draining

1. Start the vehicle and allow to warm up to operating temperature.
2. Position the vehicle on a flat level surface.



WARNING

Hot engine oil can burn you, take precautions not to touch the oil when draining.

3. Remove the oil filler bolt (F).
4. Place a suitable drain pan under the oil drain bolt (D).
5. Remove the oil drain bolt using a 12 mm socket. Allow the oil to drain from the vehicle.



General Maintenance

Transmission Oil - Refilling

1. Install a new sealing washer onto the drain bolt and thread the drain bolt in by hand. Tighten the drain bolt to 13 ft lb (18 N-m).
2. Remove the check bolt (C).
3. Fill the final drive with final drive oil through the filler hole (F) until it is level with the check bolt hole.

Change: 0.12 qt (0.11 L)

Disassembly: 0.13 qt (0.12 L)

4. Install the check bolt and filler bolt with new sealing washers. Tighten to 13 ft lb (18 N-m).

Spark Plug Inspection

Standard Spark Plug: NGK CR7HSA

Spark Plug Gap: 0.024 - 0.028 in. (0.6 - 0.7 mm)

Spark Plug Torque: 9 ft lb

The spark plug is an important engine component and is easy to inspect. The condition of the spark plug can indicate the condition of the engine. For example, a very white center electrode porcelain color could indicate an intake air leak or carburetion problem for that cylinder. Do not attempt to diagnose such problems yourself. Instead, take the machine to an authorized ARGO dealer. You should periodically remove and inspect the spark plug because heat and deposits will cause the spark plug to slowly break down and erode. If electrode erosion becomes excessive, you should replace the spark plug with one of the proper type.

Before installing the spark plug, measure the electrode gap with a feeler gauge and adjust to specification.

When installing the spark plug, always clean the gasket surface and use a new gasket. Wipe off any grime from the threads and tighten to the specified torque.

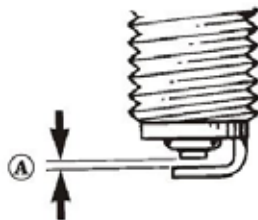

A. Spark plug gap

Air Filter Cleaning

The air cleaner accumulates dust and must be cleaned periodically. If the ATV is ridden in dusty areas, the air cleaner must be cleaned at more frequent intervals than specified in the Maintenance Schedule. If the ATV is submerged in water, the air cleaner should be checked and water should be drained from the air cleaner housing before starting the engine.

To clean the air cleaner:

1. Remove the seat.
2. Remove the air filter case cover.

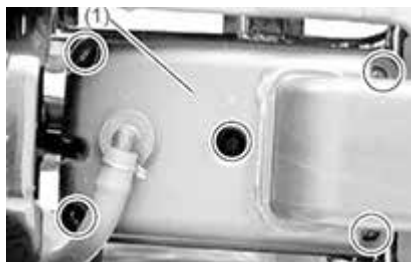

1. Air filter case cover

General Maintenance

Air Filter Cleaning (continued)

3. Remove the air filter element and separate it from the box.
4. Wash the element gently but thoroughly in solvent.
5. Squeeze the excess solvent out of the filter and let it dry.



1. Air filter case element



WARNING

POTENTIAL HAZARD

Using low flash point solvents or gasoline to clean the air filter element.

WHAT CAN HAPPEN

Low flash point solvents or gasoline can catch fire or explode increasing the risk of an accident or injury.

HOW TO AVOID THE HAZARD

Use parts cleaning solvent to clean the air filter element.



CAUTION

Do not twist the air filter element when squeezing it.

6. Inspect the air filter element. Replace if damaged.
7. Apply a quality foam air filter oil to the element. If foam air filter oil is not available, motor oil may be used.

NOTE: The element should be wet but not dripping with oil.

8. Reinstall the element to the air filter case.
9. Reinstall the element assembly and components removed for access.

Valve Clearance Adjustment

The correct valve clearance changes with use, resulting in improper fuel/air supply or engine noise. To prevent this, the valve clearance must be adjusted regularly. This adjustment however, should be left to an authorized ARGO service technician.

Shock Absorbers

Each shock absorber should be visibly checked weekly for excessive fluid leakage (some seal leakage may be observed but does not indicate the shock is in need of replacement), cracks or breaks in the lower case, or a bent shock rod. If any one of these conditions is detected, replacement is necessary.

NOTE: When the ATV is operated in extremely cold weather (-23°C/-10°F or colder), a small amount of leakage may be present. Unless the leakage is excessive, replacement is not necessary.

General Maintenance

Idle Speed Adjustment

Specified Idle Speed: 1700 rpm

NOTE: A diagnostic tachometer must be used for this procedure.

1. Start the engine and warm it up for a few minutes at approximately 1,000 to 2,000 rpm. Occasionally rev the engine to 4,000 to 5,000 rpm. The engine is warm when it quickly responds to the throttle.
2. Connect the tachometer and set the idle to the specified idling speed by adjusting the throttle stop screw. Turn the screw in to increase engine speed, and out to decrease engine speed.



1. Throttle stop screw

Throttle Lever Adjustment

NOTE: Adjust the engine idle speed before adjusting the throttle lever free play.

To adjust throttle free play:

1. Slide the rubber sleeves back to expose the throttle cable adjuster.
2. Loosen the lock nut, then turn the adjuster to obtain the correct free play. (0.12 - 0.2 in (3 - 5 mm)).
3. Tighten the locknut and reinstall the sleeve.

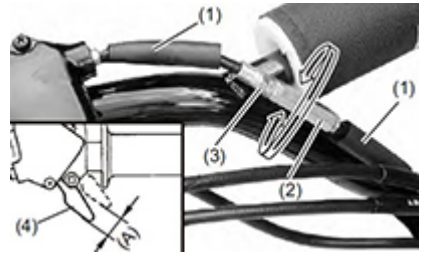

1. Rubber sleeve
 2. Cable adjuster
 3. Locknut
 4. Throttle lever
- (A) 0.12 - 0.2 in (3 - 5 mm)

Front Brake Shoe Inspection

Brake shoe wear inspection requires the disassembly of the brake assembly. If the lining thickness is below the wear limit of 0.08 in (2.0 mm), replace the brake shoes as a set. These procedures should be performed by an authorized ARGO dealer.

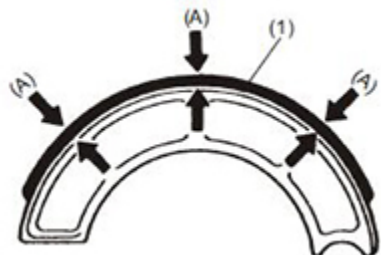

1. Lining
- (A) Lining thickness

General Maintenance

Rear Brake Pad Inspection

A wear indicator is provided on each brake. The indicators allow checking of brake pad wear. Check the position of the indicator. If the indicator reaches the wear limit line, consult an authorized ARGO dealer to replace the brake pads.



1. Wear indicator
2. Rear brake

Front Brake Lever Free Play Adjustment

Specified free play: 0.4 - 0.8 in (10 - 20 mm)

The front brake lever free play should be adjusted to 0.4 - 0.8 in (10~20 mm) at the tip of the brake lever. If the free play is incorrect, adjust as follows:

1. Loosen the upper locknut and fully turn the adjustment bolt.
2. Loosen the lower locknut.
3. Turn the lower adjusting bolt until specified free play is obtained.
4. Tighten the lower locknut.
5. While applying the front brake, turn out the upper adjusting bolt until the upper and lower cable lengths are equal. The cable joint will become vertical.
6. Tighten the upper locknut.

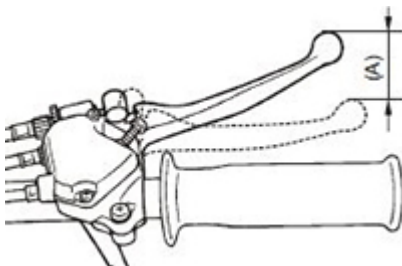

(A) Free play 0.4 - 0.8 in (10 - 20 mm)

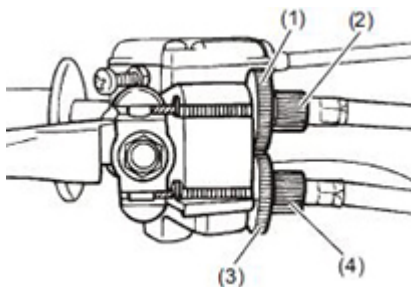

1. Upper locknut
2. Upper adjusting bolt
3. Lower locknut
4. Lower adjusting bolt

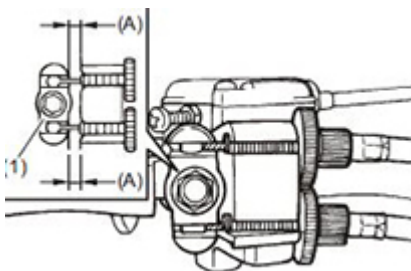

1. Cable joint
- (A) Cable length

General Maintenance



WARNING

POTENTIAL HAZARD

Operating with improperly serviced or adjusted brakes.

WHAT CAN HAPPEN

You could lose braking ability, which could increase the risk of an accident or injury.

HOW TO AVOID THE HAZARD

After servicing:

Make sure the brakes operate smoothly and the free play is correct.

Make sure the brakes do not drag.

Replacement of brake components require professional knowledge. These procedures should be performed by an authorized ARGO dealer.

Brake Fluid Inspection

Check if the fluid level is below the lower level mark through the inspection window.

1. Lower level mark (Hand brake lever)



WARNING

POTENTIAL HAZARD

Brake fluid contacting the skin or eyes.

WHAT CAN HAPPEN

May cause irritation or injury.

HOW TO AVOID THE HAZARD

Avoid contacting brake fluid with the skin or eyes. In case of contact, flush thoroughly with water and call a doctor if your eyes were exposed.

NOTE:

As the brake pads wear, brake fluid level drops, automatically compensating for wear. There are no adjustments to perform, but fluid level and pad wear must be inspected periodically. The system must be inspected frequently to ensure there are no fluid leaks.

If the brake lever travel become excessive and the brake pads are not worn beyond the recommended limit, there is probably air in the brake system and it must be bled. See your authorized ARGO dealer for this service.

General Maintenance



CAUTION

- To prevent damage to the brake system, use only fluid from a sealed container. Never allow contaminants (dirt, water, etc.) to enter the brake fluid reservoir.
- Brake fluid can damage paint and plastic, so handle the fluid with care. When adding brake fluid, be sure the reservoir is horizontal before removing the cover to prevent accidental spilling.
- Use only DOT 4 brake fluid from a sealed container.

Drive Chain Slack - Checking

Inspect the drive chain while all tires are touching the ground. Check the slack at the position shown in the figure. The normal vertical deflection is approximately 0.4 - 0.8 in (10~20 mm). If the deflection exceeds 20 mm (0.8 in), adjust the chain slack.

(A). 0.4 - 0.8 in (10 - 20 mm)

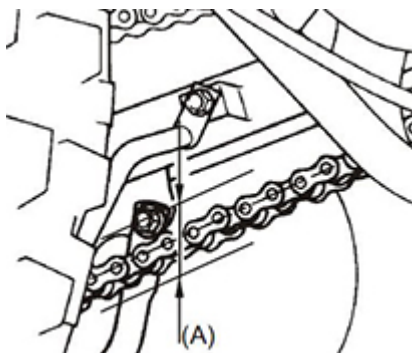

Drive Chain Slack - Adjusting

Tightening Torque

Axle Holding Bolts (Upper)

48 ft lb (65 Nm)

1. Loosen the upper and lower axle holding bolts.
2. Turn the adjusting nut to decrease or increase chain slack.
3. Tighten the upper and lower axle holding bolts.

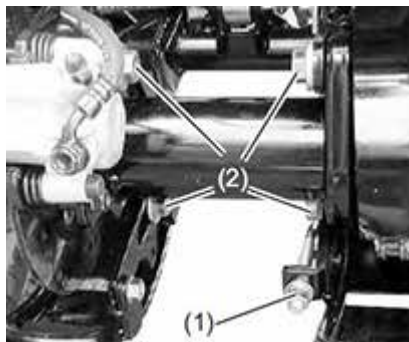

1. Hub stopper nut
2. Axle holding bolts (x4)



CAUTION

Too little chain slack will overload the engine and other important parts. Keep the slack within the specified limit.



1. Adjust nut

General Maintenance

Drive Chain - Cleaning and Lubrication

Recommended Lubrication:

SAE 30-50 motor oil

The drive chain is equipped with rubber O-rings between the chain plates. Steam cleaning, high- pressure washes, and certain solvents can damage these O-rings. Use only kerosene to clean the drive chain. Wipe it dry, and thoroughly lubricate the chain. Do not use any other lubricants on the drive chain. They may contain solvents that could damage the O-rings.



1. O-rings

Cable Inspection and Lubrication

Recommended Lubrication:

SAE 10W40 motor oil

Lubricate the inner cables and the cable ends. If the cables do not operate smoothly, see an authorized ARGO dealer to replace them.



WARNING

POTENTIAL HAZARD

Damaged control cables.

WHAT CAN HAPPEN

Corrosion can result when the outer covering of control cables becomes damaged. Cables can also become frayed or kinked. Operation of controls could be restricted, which could cause accident or injury.

HOW TO AVOID THE HAZARD

Inspect cables frequently. Replace damaged cables.

Brake Lever Lubrication

Recommended Lubrication:

Lithium-soap-based grease (all purpose)

Lubricate the pivoting points of the brake levers.

Knuckle Shaft and Rear Fork Shaft Lubrication

Recommended Lubrication:

Lithium-soap-based grease (all purpose)

Lubricate the pivoting points .



General Maintenance

Wheel - Removal and Installation

Wheel Nut Torque

Front: 30 ft lb (40 Nm)

Rear: 30 ft lb (40 Nm)

1. Park the ATV on level ground and engage the front brake lever lock.
2. Loosen the wheel nuts on the wheel to be removed. Do not remove the wheel nuts from the wheel studs.
3. Using a suitable jack, elevate the ATV.
4. Remove the wheel nuts.
5. Remove the wheel.
6. Install the wheel and install wheel nuts.
7. Tighten in a crisscross pattern to 30 ft-lb.
8. Remove the jack.

Battery

Your ATV battery is located in a compartment under the seat. The battery is sealed, so it is not necessary to check the electrolyte level or add distilled water. If the battery seems weak, see your authorized ARGO dealer for information on recharging or replacement. If you replace the battery, choose one that is sealed and equivalent to the original. Be sure to read and follow all safety precautions indicated on the battery.



CAUTION

- Do not attempt to remove the caps from the battery cells as this may damage the battery.
- Although the battery is sealed, it vents explosive gases and should be handled with appropriate care.



WARNING

POTENTIAL HAZARD

Allowing open flames or sparks near the battery.

WHAT CAN HAPPEN

Gases may explode and possibly cause injury.

HOW TO AVOID THE HAZARD

Do not allow open flames or sparks near the battery.

General Maintenance

NOTE:

- When the ATV is to be stored for an extended period, remove the battery from the vehicle and charge it fully. Then store it in a cool, dry place. If the battery is to be left on the vehicle, disconnect the negative cable from the battery terminal.
- Battery posts, terminals and related accessories contain lead and lead compounds. **Wash hands after handling.**

Battery - Removal

1. Make sure the ignition switch is OFF.
2. Remove the seat (page 33).
3. Remove the battery cover, by removing the mount bolts.
4. Disconnect the negative (-) terminal lead from the battery first, then disconnect the positive (+) terminal lead.
5. Remove the battery.

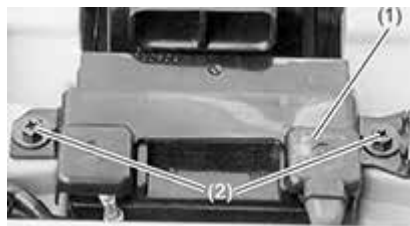

1. Battery cover
2. Mount bolt

Battery - Installation

1. Make sure the ignition switch is OFF.
2. Install the battery.
3. Ensure battery cables are routed correctly. Connect the positive (+) terminal lead first, then connect the negative (-) terminal lead. Securely fasten the bolts.
4. Install the battery cover and install the mount bolts. Tighten securely.
5. Install the seat.



1. Battery
2. Positive (+) terminal lead
3. Negative (-) terminal lead

General Maintenance

Charging / Maintenance Charging

NOTE: ARGO recommends the use of a battery charger/maintainer. Maintenance charging is required on all batteries not used for more than two weeks or as required by battery drain.

1. When charging a battery in the vehicle, be sure the ignition switch is in the OFF position.
2. Clean the battery terminals with a solution of baking soda and water.

NOTE: The sealing strip should NOT be removed and NO fluid should be added.

3. Ensure the charger and battery are in a well-ventilated area and the charger is unplugged from the 110-volt electrical outlet.
4. Connect the red terminal lead from the charger to the positive (+) terminal of the battery; then connect the black terminal lead of the charger to the negative (-) terminal of the battery.
5. Plug the battery charger/maintainer into a 110-volt electrical outlet.
6. Follow charging instructions supplied with the charger/maintainer.

NOTE: Not using a battery charger with the proper float maintenance will damage the battery if connected over extended periods

7. Once the battery has reached full charge, unplug the charger from the 110-volt electrical outlet.

NOTE: If, after charging, the battery does not perform to operator expectations, bring the battery to an authorized ARGO dealer for further troubleshooting.

Jump-Starting

NOTE: ARGO does not recommend jump-starting a vehicle with a dead battery but rather to remove the battery, service it, and correctly charge it; however, in an emergency, it may be necessary to jump-start an ATV. If so, use the following procedure to carefully and safely complete this procedure.



WARNING

Improper handling or connecting of a battery may result in severe injury including acid burns, electrical burns, or blindness as a result of an explosion. Always remove rings and watches.

1. Remove the battery cover and any terminal boots on the vehicle to be jump-started.

General Maintenance



WARNING

Any time service is performed on a battery, the following must be observed: keep sparks, open flame, cigarettes, or any other flame away. Always wear safety glasses. Protect skin and clothing when handling a battery. When servicing battery in enclosed space, keep the area well-ventilated. Make sure battery venting is not obstructed.

2. Inspect the battery for any signs of electrolyte leaks, loose terminals, or bulging sides. A leaking or bulging battery case may indicate a frozen or shorted battery.



WARNING

If any of these conditions exist, **DO NOT** attempt a jump-start, boost, or charge the battery. An explosion could occur causing serious injury.

3. Inspect the vehicle to be used for jump-starting to determine if voltage and ground polarity are compatible. The vehicle must have a 12-volt DC, negative ground electrical system.



CAUTION

Always make sure the electrical systems are of the same voltage and ground polarity prior to connecting jumper cables. If not, severe electrical damage may occur.

4. Move the vehicle to be used for the jump-start close enough to ensure the jumper cables easily reach; then shift ATV into neutral, set and lock the brakes, shut off all electrical accessories, and turn the ignition switch OFF.

NOTE: Make sure all switches on the vehicle to be jump-started are turned OFF.

5. Disconnect all external accessories such as cell phones, GPS units, and radios on both vehicles.



CAUTION

Failure to disconnect electronic accessories during jump-starting may cause system damage due to potential power spikes.

6. Attach one clamp of the positive (red) jumper cable to the positive (+) terminal (1) of the dead battery (C) being careful not to touch any metal with the other clamp; then attach the other clamp of the positive (red) jumper cable to the positive (+) terminal (2) of the good battery (B).

- A - Unpainted surface on engine
- B - Good battery
- C - Dead battery

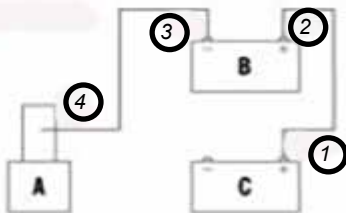

NOTE: Some jumper cables may be the same color but the clamps or ends will be color-coded red and black.

General Maintenance

- Attach one clamp of the negative (black) jumper cable to the negative (-) terminal (3) of the good battery (B); then attach the other clamp of the negative (black) jumper cable (4) to an unpainted metal surface (A) on the engine or frame well away from the dead battery and fuel system components.



WARNING

Never make the final connection to a battery as a spark could ignite hydrogen gases causing an explosion of the battery resulting in acid burns or blindness.

- Stand well away from the dead battery and start the vehicle with the good battery. Allow the vehicle to run for several minutes applying some charge to the dead battery.
- Start the vehicle with the dead battery and allow it to run for several minutes before disconnecting the jumper cables.
- Remove the jumper cables in opposite order of hook-up (4, 3, 2, 1). Be careful not to short cables against bare metal.

NOTE: Have the battery and electrical system checked prior to operating the vehicle again.

Fuse Replacement

When frequent fuse failure occurs, it usually indicates a short circuit or an overload in the electrical system. See your authorized ARGO dealer for repair.



CAUTION

To prevent accidental short-circuiting, turn off the ignition switch before checking or replacing a fuse.



WARNING

POTENTIAL HAZARD

Using an improper fuse.

WHAT CAN HAPPEN

An improper fuse can cause damage to the electrical system which could lead to a fire.

HOW TO AVOID THE HAZARD

Always use a fuse of the specified rating. Never use a material in place of the proper fuse.

General Maintenance

Fuse Holder

Specified Fuse: 7A

The fuse holder is located in the storage box under the seat.

1. Remove the seat.
2. Open the fuse holder and lift out the fuse with the clips.
3. Slide the old fuse out of the clips and discard it.
4. Slide the clips onto the ends of the new fuse, push them back into the fuse holder, and close the fuse holder.
The spare fuse is on the battery cover.

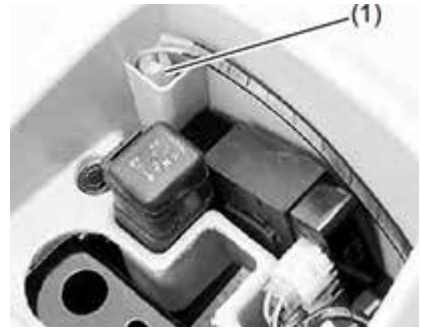

1. Fuse holder

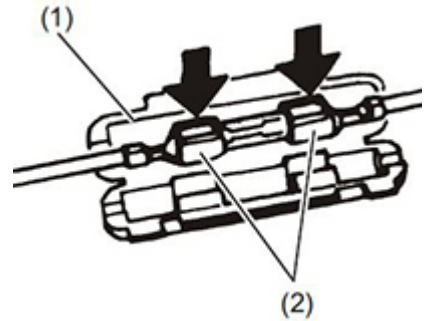

1. Fuse holder
2. Clip



CAUTION

- Do not pry the clips open to get a fuse out, you could bend them and cause poor contact with the new fuse. A loose fuse could cause damage to the electrical system and even start a fire.
- After replacing the fuse, be sure to return the fuse holder to its original location.

General Maintenance

Spark Arrester Cleaning

Be sure the exhaust pipe and muffler are cool before cleaning the spark arrester.

1. Remove the bolt.
2. Remove the tailpipe by pulling it out of the muffler.
3. Tap the tailpipe lightly, then use a wire brush to remove any carbon deposits from the spark arrester portion of the tailpipe..
4. Insert the tailpipe into the muffler and align the screw holes.
5. Install the bolt. Tighten securely.

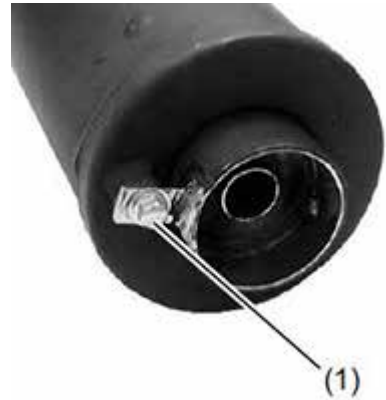

1. Bolt

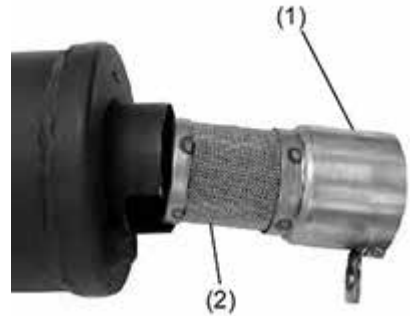

1. Tailpipe
2. Spark arrester



WARNING

POTENTIAL HAZARD

Improper cleaning of the spark arrester.

WHAT CAN HAPPEN

Could injure the eyes.

Could cause burns.

Could cause carbon monoxide poisoning, possible leading to death.

Could start a fire.

HOW TO AVOID THE HAZARD

When cleaning the spark arrester:

Always let the exhaust system cool prior to touching exhaust components.

Do not start the engine when cleaning the exhaust system.

NOISE REGULATION

TAMPERING WITH NOISE CONTROL SYSTEM PROHIBITED:

Federal law prohibits the following acts or the causing thereof: (1) The removal or rendering inoperative by any person other than for purposes of maintenance, repair, or replacement of any device or element of design incorporated into any new vehicle for the purpose of noise control prior to its sale or delivery to the ultimate purchaser or while it is in use or (2) the use of the vehicle after such device or element of design has been removed or rendered inoperative by any person.

“AMONG THOSE ACTS PRESUMED TO CONSTITUTE TAMPERING ARE THE ACTS LISTED BELOW”.

These acts include tampering with the following systems; i.e., modification, removal, etc.

Exhaust system: Muffler
Exhaust pipe
Silencer

Intake system: Air cleaner case
Air cleaner element
Intake duct

Troubleshooting

Engine doesn't turn over

Possible Cause	Solution
Tripped circuit breaker	Reset the breaker
Low battery voltage	Recharge battery to 12.5 VDC
Loose battery connections	Check all connections and ignition
Loose solenoid connections	Check all connections and ignition

Engine turns over but fails to start

Possible Cause	Solution
Out of fuel	Refuel
Clogged fuel filter	Inspect, clean or replace
Water is present in fuel	Drain the fuel system and refuel
Fouled or defective spark plug	Inspect plug, replace if necessary
Crankcase filled with water or fuel	Immediately see your dealer
Low battery voltage	Recharge battery to 12.5 VDC
Mechanical failure	See your dealer

Engine pings or knocks

Possible Cause	Solution
Poor quality or low octane fuel	Replace with recommended fuel
Incorrect ignition timing	See your dealer
Incorrect spark plug gap or heat range	Set gap to specs or replace plug

Engine backfires

Possible Cause	Solution
Weak spark from spark plug	Inspect, clean and/or replace spark plug
Incorrect spark plug gap or heat range	Set gap to specs or replace plug
Old or non-recommended fuel	Replace with new fuel
Incorrectly installed spark plug wire	See your dealer
Incorrect ignition timing	See your dealer
Mechanical failure	See your dealer

Engine runs irregularly, stalls or misfires

Possible Cause	Solution
Fouled or defective spark plug	Inspect, clean and/or replace spark plug
Worn or defective spark plug wire	See your dealer
Incorrect spark plug gap or heat range	Set gap to specs or replace plug
Loose ignition connection	Check all connections and tighten
Water present in fuel	Replace with new fuel

Troubleshooting

Possible Cause	Solution
Low battery voltage	Recharge battery to 12.5 VDC
Kinked or plugged fuel vent line	Inspect and replace
Incorrect fuel	Replace with recommended fuel
Clogged air filter	Inspect, clean or replace
Other mechanical failure	See your dealer
Possible lean mixture fuel cause	
Low or contaminated fuel	Add or change fuel, clean fuel system
Low octane fuel	Replace with recommended fuel
Clogged fuel filter	Replace filter
Possible rich mixture fuel cause	
Fuel is very high octane	Replace with lower octane fuel
Engine stops or loses power	
Possible Cause	Solution
Out of fuel	Refuel
Kinked or plugged fuel vent line	Inspect and replace
Water present in fuel	Replace with new fuel
Fouled or defective spark plug	Inspect, clean and/or replace spark plug
Worn or defective spark plug wire	See your dealer
Incorrect spark plug gap or heat range	Set gap to specs or replace plug
Loose ignition connection	Check all connections and tighten
Low battery voltage	Recharge battery to 12.5 VDC
Incorrect fuel	Replace with recommended fuel
Clogged air filter	Inspect, clean or replace
Other mechanical failure	See your dealer
Overheated engine	Clean engine exterior See your dealer

SECTION 9

Preparation For Storage



CAUTION

Prior to storing your ATV, it must be properly serviced to prevent rusting and component deterioration.

Cleaning the Vehicle

Frequent, thorough cleaning of your ATV will not only enhance its appearance but will improve its general performance and extend the useful life of many components.

1. Before cleaning the ATV:
 - a. Block off the end of the exhaust pipe to prevent water entry. A plastic bag and strong rubber band may be used.
 - b. Make sure the spark plug and all filler caps are properly installed.
2. If the engine case is excessively greasy, apply degreaser with a paintbrush. Do not apply degreaser to wheel axles.
3. Rinse the dirt and degreaser off with a garden hose. Use only enough pressure to do the job.



WARNING

- **Wet brakes may have reduced stopping ability, increasing the chance of an accident. Test the brakes after washing. Apply the brakes several times at slow speeds to let friction dry out the linings.**
- **Excessive water pressure may cause water seepage and deterioration of wheel bearing, brakes, transmission seals and electrical devices. Many expensive repair bills have resulted from improper high-pressure detergent applications such as those available in coin-operated car washes.**

4. Once most of the dirt has been hosed off, wash all surfaces with warm water and mild, detergent-type soap. An old toothbrush or bottle brush is handy for hard to reach places.
5. Rinse the ATV off immediately with clean water and dry all surfaces with a chamois, clean towel or soft absorbing cloth.
6. Clean the seat with vinyl upholstery cleaner to keep the cover pliable and glossy.
7. Automotive type wax may be applied to all painted and chrome plated surfaces. Avoid combination cleaner-waxes. Many contain abrasives, which may mar the paint or protective finish. When finished cleaning, start the engine and let it idle for several minutes.

Storage

Short Term

Always store your ATV in a cool, dry place and if necessary, protect it against dust with a porous cover.



WARNING

Storing the ATV in a poorly ventilated room or covering it with a tarp while it is still wet, will allow water and humidity to seep in and cause rust. To prevent corrosion, avoid damp cellars, stables and area where strong chemicals are stored.

Long Term

Before storing your ATV for several months:

1. Follow all the instructions in the “Cleaning” section of this chapter.
2. Turn the fuel lever to “OFF”.
3. Fill up the fuel tank and add fuel stabilizer to prevent the fuel from deteriorating.
4. Perform the following steps to protect the cylinder, piston rings, etc. from corrosion.
 - a. Remove the spark plug cap and spark plug.
 - b. Pour a teaspoonful of engine oil into the spark plug bore.
 - c. Install the spark plug cap onto the spark plug and then place the spark plug on the cylinder head so that the electrodes are grounded.
 - d. Turn the engine over several times with the starter.
 - e. Remove the spark plug cap from the spark plug and then install the spark plug and the spark plug cap.
5. Lubricate all control cables and the pivoting points of all levers and pedals.
6. Check and if necessary, correct the tire air pressure and then block up the ATV so that all of its wheels are off the ground. Alternatively, turn the wheels a little every month in order to prevent the tires from becoming degraded in one spot.
7. Cover the muffler outlet with a plastic bag to prevent moisture from entering it.
8. Remove the battery and fully charge it. Store it in a cool, dry place and charge it once a month.

Do not store the battery in an excessively cold or warm place less than 0 C or more than 30 C.

9. Make necessary repairs before storing the ATV.

SECTION 10

Warranty



LIMITED WARRANTY

Ontario Drive & Gear Limited (hereinafter "ARGO") extends a limited warranty on each new ARGO ATV, XTV, and SSV and on each genuine ARGO part and accessory sold by an authorized ARGO dealer. The limited warranty on an ARGO ATV, XTV, or SSV is provided to the original retail purchaser; however, the balance of the unused warranty may be transferred to another party through an ARGO dealer, but any such transfer will not extend the original term of the warranty. Warranty coverage is limited to the country in which the original retail purchase occurs and to the original retail purchaser resident in that country or, if transferred to a resident in that country for the balance of the remaining warranty.

The warranty is validated upon examination of said parts by ARGO or an authorized ARGO dealer. ARGO reserves the right to inspect such parts at its factory for final determination if warranty should apply. ARGO will repair or replace, at its option (including any related labor charges), any parts that are found to be warrantable in material or workmanship. This repair work must be done by an authorized ARGO dealer. No transportation charges, rental charges, or inconvenience costs will be paid by ARGO.

ARGO does not assume any liability for incidental or consequential damages.

WARRANTY COVERAGE PERIOD

1. Standard Warranty - 1 year from the date of sale.

Argo Promotional Extended Warranty provided at the time of sale will follow the Standard Warranty guidelines and coverage. Excludes batteries.

The warranty does not cover normal wear, abuse, or corrosion.

WARRANTY LIMITATIONS AND EXCLUSIONS

This ARGO limited warranty will become null and void if:

1. Failure to perform the proper break-in procedure and all related maintenance, storage procedures (if stored for extended periods), and/or service as recommended in the Operator's Manual.
2. Repairs and/or adjustments made by anyone other than an authorized ARGO dealer unless instructed by ARGO.
3. Any modification, addition, or removal of parts unless instructed to do so by ARGO.
4. Removal of the engine for use in another vehicle.
5. Use of improper fuels, lubricating oils, or spark plug(s).
6. Vehicle has been involved in an accident or subject to misuse, abuse, or negligent operation, including overloading.
7. Use of the vehicle in any way for racing purposes.
8. Removal or mutilation of the Product Identification Number or Engine Serial Number.
9. Damage due to improper transportation.
10. Use of aftermarket or unapproved parts, accessories or attachments not sold by ARGO.



11. Damage caused by Acts of God, such as storm damage, hail, lightning, and other environmental conditions.
12. Collision, fire, theft, freezing, vandalism, riot, explosion, or objects striking the vehicle.
13. Tampering with the vehicle's hour meter.

In consideration of the foregoing, any implied warranty is limited in duration to the warranty periods set forth. This warranty gives you specific legal rights, and you may also have other rights which vary from state/province to state/province and country to country. Some jurisdictions do not allow limitations on how long an implied warranty lasts, so the above limitations may not apply to you.

WARRANTY PROCEDURE / OWNER RESPONSIBILITY

At the time of sale, a Training Certificate (if applicable) or an Owner Registration form is to be completed by the selling dealer and consumer. The receipt of the form by ARGO is a condition precedent to warranty coverage. It is the selling dealer's responsibility to retain and/or submit appropriate electronic registration to initiate warranty coverage.

The selling dealer is responsible to furnish the consumer a signed copy of the form which must be presented to the dealer when requesting warranty service. The registration form is the consumer's proof of ownership and warranty eligibility. The form is to be used by the dealer to validate the warranty claim. Retain your copy of the Owner Registration form and keep it in a safe place.

When warranty repair is suspected, the vehicle should be taken to an authorized ARGO dealer, who has the primary responsibility to perform warranty repairs.

The authorized ARGO dealer will examine the vehicle or part to determine if a warrantable condition exists. If a warrantable condition appears to exist, the dealer will repair or replace, at ARGO's option, including any related labor costs, all parts that are found to be warrantable and any other parts which the warrantable part caused to be damaged.

It is the owner's responsibility to maintain and service the vehicle in accordance with ARGO's recommendations in the Operator's Manual. To protect yourself and your vehicle, follow all safety and service tips. ARGO will NOT warrant repairs required as a result of not performing standard operator maintenance, storage procedures, and service as outlined in the Operator's Manual.

Should you have any questions concerning the warranty, contact an authorized ARGO dealer.

EPA EMISSIONS CONTROL SYSTEM WARRANTY:

LIMITED WARRANTIES EMISSION CONTROL SYSTEMS:

ARGO warrants to the owner of any 2025 and subsequent model year ATV that the ATV is designed, built and equipped to conform at the time of sale with all applicable emission standards and is free from defects in materials and workmanship which would cause it to fail to conform with applicable requirements during the specified time and mileage limits.

A qualified repair shop or person of the owner's choosing may maintain, replace, or repair emission control devices and systems with original or equivalent replacement parts. However, warranty, recall and all other services paid for by ARGO must be performed at an authorized ARGO service center except for the emergency condition described below.

Your Warranty Rights and Obligations:

In the United States and Canada, new ATVs must be designed, built and equipped to meet stringent Federal anti-smog standards. ARGO must warrant the emissions control system on your ATV for the periods of time listed below, provided there has been no abuse, neglect or improper maintenance of your ATV. Your emissions control system may include parts such as the sensors, the ignition and the engine computer. Also included may be hoses, connectors and other emissions-related assemblies. Where a warrantable condition exists, ARGO will repair your ATV at no cost to you, including diagnosis, parts, and labor.

Owner's Responsibility:

As the ATV owner, you should also be aware that ARGO may deny you warranty coverage if your vehicle or a part has failed due to abuse, neglect, improper maintenance or unapproved modifications. If you have any questions regarding your warranty rights and responsibilities or if an authorized ARGO dealer cannot repair your ATV or honor your claim within a reasonable period of time, contact ARGO for assistance at 1-218-683- 5366. If you are not satisfied with the way in which a warranty claim is resolved by ARGO, you may write directly to:

Director, Gasoline Engine Compliance Center
Compliance Division
U.S. EPA
2000 Traverwood Drive
Ann Arbor, MI 48105

You must operate and maintain your ATV according to the requirements of the Owner's Manual including the maintenance schedule. This schedule is designed to keep your ATV emission control systems functioning properly and safely. You should keep receipts and records of maintenance and service but ARGO will not deny a warranty claim solely because of lack of maintenance records.

If an ARGO USA service center is not available within 100 miles, ARGO will reimburse you for those emergency repairs, including diagnosis, covered by the Emissions Warranties. Labor reimbursement is at a geographically-appropriate hourly labor rate for ARGO recommended time allowance. For reimbursement, present the replacement parts and a copy of the paid receipt to ARGO.

The use of replacement parts not equivalent to the original parts may impair the effectiveness of your ATV emissions control systems. If such a replacement part is used in the maintenance or repair of your ATV and an authorized ARGO dealer determines it is defective or caused a failure of a warranted part, your claim for repair to bring your ATV into compliance with applicable standards may be denied. If the part in question is not related to the reason your ATV fails to meet the standards, your claim will not be denied.

Emissions Warranty Coverage:

This warranty begins on the date the ATV is delivered to the first purchaser, or the date it is first used as a demonstrator, lease, or company ATV, whichever comes first and continues for the time and mileage listed below:

Time 30 months

Mileage 2,500 kilometers (1,550 miles) whichever comes first.

Warranted Parts:

Fuel Tank
Fuel Cap
Fuel Line
Fuel Line Fittings
Clamps*
Carburetor
Press. Relief Valves*
Control Valves*
Control Solenoids*
Electronic Controls*
Control Cables*
Control Linkages*
Purge Valves
Vapor Hoses
Liq/Vapor Separator
Air Intake System
Press Relief Fittings*
Vacuum Control Diaphragms*
Engine
Engine Electronic Control Module*
Ignition System*
Sensors*
Exhaust System and Components
Spark Arrestor
Fuel Injection System and Components

*Components that are part of the engine, fuel injection system, fuel evaporative system and emissions control system.

Maintenance Record

MAINTENANCE INTERVAL	DATE OF SERVICE	MILEAGE	SERVICING DEALER NAME AND ADDRESS	REMARKS
1 Month				
3 Months				
6 Months				
12 Months				
18 Months				
24 Months				
30 Months				
36 Months				
42 Months				
48 Months				
54 Months				
60 Months				



WARNING

Improper ATV use can result in SEVERE INJURY or DEATH.



**ALWAYS USE
AN APPROVED
HELMET AND
PROTECTIVE
GEAR**



**NEVER USE
ON PUBLIC
ROADS**



**NEVER CARRY
PASSENGERS**



**NEVER USE
WITH DRUGS
OR ALCOHOL**

NEVER operate:

- without proper training or instruction
- at speeds too fast for your skills or the conditions
- on public roads - a collision can occur with another vehicle
- with a passenger - passengers affect balance and steering and increase risk of losing control

ALWAYS:

- use proper riding techniques to avoid vehicle overturns on hills and rough terrain and in turns
- avoid paved surfaces - pavement may seriously affect handling and control

**LOCATE AND READ OWNER'S MANUAL.
FOLLOW ALL INSTRUCTIONS AND WARNINGS.**