



2024 OPERATOR'S MANUAL



Aurora Pro 950 XT 8x8



CAUTION

Aurora Pro 950 XT models are not amphibious and may sink! Do not attempt any water crossing that would float the vehicle!

*This vehicle is not a toy. Never allow anyone under
16 years of age to operate this XTV.*

NOTE

Read this manual before you operate your ARGO XTV. It contains safe operating instructions and warns the user about potential hazards that can result in personal injury.

Warnings are identified in the text by the following symbol:



WARNING

Warning text warns the user about potential hazards that can result in personal injury or death.

Cautions are identified in the text by the following symbol:



CAUTION

Caution text contains cautions that can prevent damage to the XTV.

This manual is based on the latest product information available at the time of printing. ARGO reserves the right to make changes at any time and without obligation.

Reproduction of any part of this publication is prohibited without prior written permission.

© 2023 ARGO



WARNING

WARNING: This product may contain fuels, oils and fluids, battery posts, terminals and related accessories which contain lead and lead compounds and other chemicals identified by the State of California to potentially cause cancer, birth defects, and other reproductive harm. These chemicals are found in vehicles, vehicle parts and accessories, both new and replacements. During maintenance, these vehicles generate used oil, waste fluids, grease, fumes and particulates, all identified by the State of California to potentially cause cancer, birth defects, and other reproductive harm.

For more information go to:

www.P65Warnings.ca.gov

PREFACE

This manual describes the controls, operation and basic maintenance procedures for all Aurora models of the ARGO from date of printing. Please take the time to read this manual carefully, for your safety and that of others. By following these instructions, you will ensure extended, trouble free operation of your vehicle. For maintenance and adjustment of the engine, refer to the engine manufacturer's operation and maintenance manual included in your vehicle's information package.

Before you drive your ARGO, make sure you understand how to use all controls, particularly the brakes and steering system. Learn how to drive your vehicle in an open level area, away from buildings, trees and other obstacles, until you are completely familiar with its operating characteristics. Drive very slowly until your driving skills improve, and drive with caution and consideration at all times. The risk of accident or injury is greatest during the first weeks of use. Take special care during this period.

ALWAYS RESPECT OUR ENVIRONMENT.

CAUTION TO THE ARGO OWNER/OPERATOR

- Make sure everyone who drives this vehicle receives proper operating instructions and reads this Operator's Manual.
- No one under the age of 16 should be allowed to operate the ARGO. Children under the age of 16 may not have the skills, abilities or judgement needed to operate the ARGO safely and may be involved in an accident causing severe injury or death.
- Never allow anyone under the influence of alcohol or any other intoxicating substance to drive or ride in the vehicle.
- Wear an approved helmet and eye protection when driving or riding in the vehicle.
- Special operating procedures described in this manual must be observed before and during water operation.
- When operating your vehicle for extended periods of time, we recommend the use of approved hearing protection.
- Equip your vehicle with a fire extinguisher and a first aid kit.
- Equip your vehicle with basic tools for emergency repairs.
- Before starting your engine, check for spilled gasoline and wipe up immediately. Gasoline is a potentially explosive substance that can cause serious personal injury when ignited.
- Keep the floor pans secured in place at all times. Fingers, feet, animal tails or paws can be injured in the drive components beneath the floor pans. The floor pans also help keep damaging debris out of the drive components.
- Make sure all passengers remain seated while the vehicle is in motion. Advise your passengers to hold onto the vehicle at all times.
- Certain terrain and steep hills cannot be traversed safely with the ARGO or any other vehicle. Do not attempt to drive over terrain that is questionable.
- Avoid driving your vehicle on asphalt or concrete roadways when possible. When the vehicle turns, its tires skid on the driving surface. Asphalt or concrete causes extensive tire wear.
- Use common sense at all times when driving your vehicle.

IMPORTANT

Operate this vehicle with safety constantly in mind. Off-road vehicles face unpredictable and often hazardous terrain conditions. It is ultimately the operator's responsibility to handle the vehicle safely within its limitations and to decide when and where to travel.

TABLE OF CONTENTS

SECTION 1 - Introduction

Message from the people who built your ARGO	1
Identification Number.....	2
Frame and Serial Number	2
Important Safety Message.....	3
Replacement Parts, Accessories and Service.....	4

SECTION 2 - Safety Information

Safety Information	5
Hangtags and Warning Labels	11
Warnings	12

SECTION 3 - Specifications

Aurora Pro 950 XT 8x8	19
-----------------------------	----

SECTION 4 - Description and Identification

Identification and Location of Controls	21
Key Switch.....	21
Throttle Control.....	21
Starter Button	21
Emergency Stop Switch	22
Headlights.....	22
Bilge Pump Switch.....	22
Dual USB Outlet.....	23
Parking Brake System	23
Hand Brake.....	24
Shifting Transmission	24
Changing Transmission Gears	24
Instrument Cluster	25
Brakes and Steering.....	26

SECTION 5 - Getting to Know Your XTV

Getting to Know Your XTV	27
Before Riding.....	27
Rider Preparation - Age Recommendation	27
Pre-Operation Checklist	27
Safe Riding Rules	27
Protective Apparel	27
Load Capacity Limits	27
Accessories.....	28
No Modifications	28
For Off-Road Use Only.....	28
Environment	29
Weather	29
Terrain.....	29
Night Riding.....	29
Paved Surfaces	29

Trail Riding	29
Turning Your XTV	30
Leaning, Weight Shift, and Balance	30
Wide Turns	30
Sharp Turns	30
Quick Turns	30
Climbing Uphill.....	31
Riding Downhill.....	31
Crossing a Slope	32
Swerving.....	32
Riding Over Rough Terrain	33
Sliding and Skidding	33
Crossing Roads	33
Cold Weather Operation	34
Parking	34
Reversing	34
Braking	35
Parking on a Slope	35
Stopping the Engine	35
Crossing Through Shallow Water.....	36
Amphibious Operation - General.....	36
Drain Plugs.....	36
Water Entry.....	37
Driving Procedures in Water.....	38
Driving Out of Water	38
Land Operation.....	39
Winter Operation	39
Use on Ice Covered Bodies of Water	39
Carrying Passenger and Cargo.....	40
Trailering and Towing.....	41
Transporting Your XTV	41
Rear Seats.....	42

SECTION 6 - Before You Ride

New Vehicle "Break-In" Procedure	43
Pre-Operation Checks	43
Checklist.....	44
Hydraulic Brakes	45
Fueling the Vehicle	45
Vented Fuel System	46
Fuel.....	46
Engine Oil.....	47
Oil Level Inspection	47
Transmission Oil Inspection	48
Throttle Lever	49
Fittings and Fasteners.....	49
Lights.....	49
Switches	49
Tires.....	49
How to Measure Tire Pressure	49
Tire Wear Limit	50

SECTION 7 - Operation

Entering the XTV	51
Starting the XTV	51
Priming Procedure	52
Stopping the Engine	53
Selecting and Changing Transmission Gears	53
Driving Straight Ahead	54
Stopping the Vehicle	54
Turning the Vehicle	54
Left Turn	55
Right Turn	55
Driving the Vehicle in Reverse	55
Turning the Vehicle While in Reverse	55
Gear Selection	55
Selecting Forward, Neutral, Reverse, High or Low	56
Recommended Gear Selections	56
Trails and Higher Speed Driving	56
Traversing Inclines	56
Mud and Snow	56
Water / Amphibious Use	56
Low Speed	56

SECTION 8 - Oil, Filter and Lubrication Information

Checking the Engine Oil Level	57
Changing Engine Oil	58
Oil Filter	58
Transmission Oil Information	59
Checking the Transmission Oil Level	59
Changing the Transmission Oil	59
Filter Information	60
Air Filter	60
Fuel Filter	60
Lubrication Information	60
Drive and Driven Clutch	60
Drive Chain	61
Outer Axle Bearing	61
Idler Shaft Outer Bearing (Easy Access Grease Zerks)	62
Inner Axle Bearing	62
Output Shaft Coupler	63
Momentary Chain Oiler System	63

SECTION 9 - Maintenance Information

Maintenance Schedule	65
20/20 Service Chart	66
100/12 Service Chart	66
Daily Checklist	67
Maintenance Procedures	68
Electrical System	68
AGM Battery	68
Activating and Charging AGM Batteries	69

Cleaning the Battery Terminals and Cable Connections	71
Electrical System Fuses	71
Spark Plugs	72
Spark Arrester.....	72
Instant Torque Drive System	72
Drive Belt.....	73
Drive Belt Adjustment	73
Drive Belt Removal.....	73
Drive Belt Installation.....	73
Clutch Maintenance.....	74
Driven Clutch Inspection.....	74
Drive Chains	75
Drive Chain Tensioner System	75
Tires and Axles	76
Axle Bearing Mounting	77
Hydraulic Brakes	77
Brake Fluid Level.....	77
Changing Brake Fluid	78
Brake Pad Inspection	78
Steering Brake Pad Inspection.....	78
Service Brake Pad Inspection	79
Parking Brake Adjustment	80
Brake Plunger Adjustment.....	80
Engine Cooling and Exhaust System	80
Engine Idle Adjustment.....	81

SECTION 10 - Troubleshooting

Troubleshooting.....	83
----------------------	----

SECTION 11 - Cleaning and Storage

Cleaning and Storage.....	85
---------------------------	----

SECTION 12 - Potential Hazards

Potential Hazards	87
-------------------------	----

SECTION 13 - Warranty

Limited Warranty	91
Emissions Warranty.....	93
Maintenance Record	95

SECTION 1

Introduction

A MESSAGE FROM THE PEOPLE WHO BUILT YOUR ARGO

Thank you for selecting an **ARGO** amphibious, off-road utility vehicle!

Ontario Drive & Gear Limited has been building **ARGO** vehicles since 1967. By listening carefully to our customers and responding to their needs, we have been constantly improving the **ARGO** and will continue to do so.

Over thirty thousand **ARGO** vehicles have provided reliable service all over the world. From Britain to the Far East, Alaska to the Antarctic, and from the tropical forests of South America to the deserts of Saudi Arabia. We are proud to provide you with a vehicle that represents the ultimate in amphibious, all-terrain transportation.

Your safety and the safety of all **ARGO** users is of the greatest concern to us. You will find numerous safety statements in this manual. Please read and follow them carefully. Always be safety conscious when you operate your **ARGO** and remember it is a motorized vehicle.

The **ARGO** is easy to drive and you will soon be tempted to take on new challenges. Please take the time to develop your driving skills before doing so. Observe the recommendations outlined in this Operator's Manual and remember; some things are just impossible, even with an **ARGO**.

WELCOME TO THE WORLD WIDE ARGO FAMILY!



PLEASE TAKE A FEW MOMENTS TO GET ACQUAINTED WITH YOUR XTV BY READING THIS OPERATOR'S MANUAL

Identification number records

Record the key identification numbers, frame serial number, engine serial number and model code information for assistance when order replacement parts.

NOTE:

The manufacturer **DISCLAIMS LIABILITY FOR ERRORS IN THIS MANUAL**, and **SPECIFICALLY DISCLAIMS LIABILITY FOR INCIDENTAL AND CONSEQUENTIAL DAMAGES** resulting from the use of the information and material in this manual.

Name: _____

Address: _____

Telephone: _____

Purchase Date (mm/dd/yyyy): _____

Model: _____

Frame Number: _____

Engine Number: _____

Key Number: _____

Frame and Engine Serial Number

The frame serial number is stamped on the front of the frame.

The engine serial number is adhered to the blower housing cover near the rear overhead valve.

These numbers are required by the dealer to complete any Warranty process. No warranty will be allowed by ARGO if the VIN or ESN has been tampered with in any way.

- Before operating this XTV, the owner and each operator must understand that this XTV was not designed or manufactured to meet specifications for use on public roads, streets, highways or thoroughfares.
- The owner and operator(s) must read and understand all the instructions for proper assembly and safe operation, as well as the instructions concerning the engine and all other portions of the XTV, as described and illustrated in this manual.
- This XTV is NOT to be operated by anyone under 16 years of age.
- This XTV is NOT a toy.
- Be sure to follow the recommended maintenance schedule and service your XTV accordingly.

PREVENTATIVE MAINTENANCE IS EXTREMELY IMPORTANT TO THE SAFE OPERATION AND LONGEVITY OF YOUR XTV

We advise you to follow the recommended maintenance program as outlined in this manual. This program is designed to ensure all critical components on this XTV are thoroughly inspected at specified intervals.

GETTING ACQUAINTED WITH YOUR XTV

This manual will provide you with a good basic understanding of the features and operation of this XTV. This manual includes important safety information. It provides information about special techniques and skills necessary to ride the XTV. It also includes basic maintenance and inspection procedures. If you have any questions regarding the operation or maintenance of your XTV, please consult dealer.

IMPORTANT SAFETY MESSAGE:

- **You should be aware that AN XTV IS NOT A TOY AND CAN BE HAZARDOUS TO OPERATE.** An XTV handles differently from other vehicles, including motorcycles and cars. A collision or rollover can occur quickly, even during routine maneuvers such as turning and driving on hills and over obstacles, if you fail to take proper precautions.
- Read this manual carefully and completely before operating your XTV. Make sure you understand all instructions.
- Pay attention to the warning and notice labels on the XTV.
- Never operate an XTV without proper training or instruction. For a training course, please consult a dealer.
- This XTV is designed exclusively for off-road use. It is not designed, properly equipped or licensed to be safely operated on public streets and highways.
- This XTV complies with all applicable off-road noise level and spark arrester laws and regulations in effect at the time of manufacture.
- Please check your local riding laws and regulations before operating this XTV.
- For your safety, follow and understand all CAUTIONS, WARNINGS and LABELS contained in this Operator's Manual.
- Keep this Operator's Manual with your XTV at all times for reference.

FAILURE TO FOLLOW THE WARNINGS and CAUTIONS CONTAINED IN THIS MANUAL CAN RESULT IN SERIOUS INJURY OR DEATH.

IMPORTANT

Operate this XTV with safety constantly in mind. Off-road vehicles face unpredictable and often hazardous terrain conditions. It is ultimately the operator's responsibility to handle the XTV safely within its limitations and to decide when and where to travel.

Precautionary Measures

Protect Your Sport

- Know all local laws relating to XTV riding,
- Respect your XTV
- Respect the environment, and
- You will gain the respect of other fellow riders.

**FOR MORE INFORMATION ON OUR FULL PRODUCT OFFERING,
VISIT OUR WEBSITE www.argoxtv.com**

- For a detailed description of warranty coverage for your XTV, refer to the Warranty section found in this Owner's Manual or visit our website.
- For a detailed description of the emissions warranty for your XTV, refer to the Emissions Warranty section of this Owner's Manual or visit our website.

***ARGO WANTS YOU TO BE SATISFIED WITH YOUR NEW XTV.
IF YOU DO NOT UNDERSTAND ANY PART OF THIS MANUAL OR ARE NOT
SATISFIED WITH THE SERVICE RECEIVED, PLEASE TAKE THE FOLLOWING
ACTIONS:***

Discuss the matter with your dealership service manager. Make sure they are aware of your concerns so they can assist you.

REPLACEMENT PARTS, ACCESSORIES and SERVICE

- Most replacement parts and accessories are typically available from your dealer. For immediate availability and convenience, it is recommended items be ordered from an authorized dealer. Take this manual and all supplements to the dealer when ordering parts in person.
- Orders may be subject to a minimum fee. A listing of authorized service providers in your area is also available on the website.
- Unapproved installation of parts or accessories can create a substantial safety hazard and increase the risk of personal injury.
- Use authorized parts only.



WARNING

All engine exhaust contains carbon monoxide, a deadly gas. Carbon Monoxide is a colorless, odorless, tasteless gas, which may be present even if you do not see or smell any engine exhaust.

Avoid Carbon Monoxide Poisoning.

- Do not run engine indoors. Even if you try to ventilate engine exhaust with fans or open windows and doors, carbon monoxide can rapidly reach dangerous levels.
- Do not run engine in poorly ventilated or partially enclosed areas such as barns, garages or carports.
- Do not run engine outdoors where engine exhaust can be drawn into a building through opening such as windows and doors.

SECTION 2

Safety Information

An XTV is NOT a Toy and Can Be Hazardous To Operate

An XTV handles differently from other vehicles such as motorcycles and cars. A collision or rollover can occur quickly, even during routine operation such as turning, driving over obstacles, on hills or rough terrain, if you do not take necessary precautions.

SEVERE INJURY OR DEATH can result if you do not follow these instructions:

- Read this manual and all CAUTION/WARNING labels carefully and follow the operating procedures described.
- Never operate an XTV without proper instruction. Take a training course.
- Parents: It is very important that your child or children understand and follow the instructions, cautions and warnings contained in this manual before operating this XTV under adult supervision.
- Never allow anyone under 16 years of age to operate this XTV.
- Some operators, even at the age of 16, may not be able to operate an XTV safely; parents should supervise such operator of the XTV at all times. Parents should permit continued use only if they determine that the operator has the ability to operate the XTV safely.
- Never permit a guest to operate this XTV unless the guest has read this manual and all product labels and has completed the training course.
- Never operate an XTV on any paved surfaces, including sidewalks, driveways, parking lots, and streets.
- Never operate this XTV on any public street, highway, or road (dirt or gravel).
- Never operate an XTV without wearing an approved helmet that fits properly. You should also wear eye protection (goggles or face shield), gloves, boots, long-sleeved shirt or jacket, and long pants.
- Never consume alcohol or drugs before or while operating this XTV.
- Never operate at excessive speeds. Always travel at a speed which is proper for the terrain, visibility and operating conditions, and your experience.
- Never attempt wheelies, jumps, or other stunts.
- Always inspect this XTV each time you use it to make sure it is in safe operating condition. Always follow the inspection, maintenance procedures and schedules described in this manual.
- Always keep both hands on the handlebars and both feet in the vehicle during operation.
- Always go slow and use caution when operating on unfamiliar terrain. Always be alert to changing terrain conditions when operating the XTV.
- Never operate the XTV on hills too steep for the abilities of the operator or the XTV. Practice on smaller hills before attempting larger hills.
- Never operate on excessively rough, slippery, or loose terrain.
- Always follow proper procedures for turning as described in this manual. Practice turning at slow speeds before attempting to turn at faster speeds. Do not turn at excessive speed.
- Always have the XTV inspected by an authorized ARGO dealer if it has been involved in any type of accident.
- NEVER OPERATE UP OR DOWN HILLS STEEPER THAN 30 DEGREES
- Always follow proper procedures for climbing hills as described in this manual. Check the terrain carefully before you start up any hill. Never climb hills with slippery or loose surfaces. Never accelerate suddenly. Never go over the top of any hill at a high rate of speed.

An XTV is NOT a Toy and Can Be Hazardous To Operate

- Always follow proper procedures for going down hills and for braking on hills as described in this manual. Check the terrain carefully before you start down any hill. Never go down a hill at a high rate of speed. Avoid going down a hill at an angle which would cause the XTV to lean sharply to one side. Go straight down the hill whenever possible.
- Avoid hills with slippery or loose surfaces. Never attempt to turn the XTV around on any hill until you have mastered the turning techniques described in this manual on level ground. Avoid crossing the side of a steep hill if possible.
- Always use proper procedures if you stall or roll backward when climbing a hill. To avoid stalling, maintain a steady speed when climbing a hill. If you stall or roll backwards, follow the special instructions for braking described in this manual. Dismount the XTV on the uphill side or to either side if pointed straight uphill. Turn the XTV around and mount the XTV following the special instructions described in this manual.
- Always check for obstacles before operating in a new area.
- Never attempt to operate over large obstacles, such as large rocks or fallen trees. Always follow proper procedures when operating over obstacles as described in this manual.
- Always use caution when skidding or sliding. On slippery surfaces, such as ice, go slow and be very cautious in order to reduce the chance of skidding or sliding out of control.
- Never operate an XTV in fast flowing water. Remember that wet brakes may have reduced stopping capability. Test your brakes after exiting any water. If necessary, apply the brake lightly several times to let friction dry out the pads.
- Always use the size and type of tires specified in this manual.
- Always maintain proper tire pressure as described in this manual.
- Never improperly install or improperly use accessories on your XTV.
- Never exceed the stated load capacity for this XTV.

An XTV is NOT a Toy and Can Be Hazardous To Operate

IMPORTANT MESSAGE TO PARENTS

Your child's safety is very important to ARGO. That is why we urge you to read this message before you let any young rider operate this XTV. Off-road riding can be fun. However, an XTV is not a toy and it can be hazardous to operate. As with any youth activity involving speed and skill such as bicycling or skateboarding, poor judgment can result in injuries and we don't want that to happen! You can help prevent accidents by making good decisions about if, when, and how your child rides this XTV.

Evaluate Riding Readiness

The first decision you'll need to make is whether your child is ready to ride. Riding readiness varies widely from one person to another, and while the minimum age recommended for this XTV is 16 years of age, there are other factors that you should consider.

Physical size and ability are important considerations. To help determine whether a youngster is big enough for this XTV, make sure your youngster can comfortably reach and work all the controls. For example, can they turn the handlebars all the way to the right and left? Can they operate the throttle and brake levers while they hold onto the hand grips? If not, the youngster is not physically ready to ride this XTV.

Before you let a youngster ride an XTV, decide whether they are physically, mentally and emotionally ready to ride.

Patience And Practice

Even if a youngster takes a certified training course, it's up to you to ensure your youngster's safety. Remember, learning to ride an XTV is a gradual step-by-step process. It takes time, patience and practice.

Always Supervise Young Riders

Supervision is another important obligation of parents. Even after youngsters have become skilled off-road riders, make sure they always have adult supervision while riding. It also helps to regularly remind young riders to follow the instructions and warnings in this manual. And remember, it's the parent's responsibility to see that the XTV is properly maintained and kept in safe operating condition.

If you choose to lend your XTV to another rider, you should understand that the decision to lend the XTV is yours.

An XTV is NOT a Toy and Can Be Hazardous To Operate

ARGO recommends the use of the below safety gear before operation:

Clothing and Gear

While riding your XTV, you will find it important to dress correctly to prevent personal injury. Below is the minimum protection recommended to wear during every ride:

1. Helmet
2. Eye Protection
3. Long Pants
4. Long Sleeve Shirt
5. Gloves
6. Boots/Ankle Protection

Helmet

There are many different types and styles of helmet to choose from today. Be sure to choose a helmet that complies with the current standards of the U.S. Department of Transportation (DOT), The Snell Memorial Foundation, or the American National Standards Institute (ANSI). Helmets that comply with one or more of the above standards have a defined label located on the inside or outside of the helmet.

These helmets should provide full-face protection.

If you damage your helmet, obtain a new one immediately.

Remember: Your helmet is not providing any safety if the chin strap is not securely fastened.

Eye Protection

Wear eye protection, such as goggles, to completely surround your eyes to prevent any dirt or other items from getting into your eyes. Sunglasses are not a form of protection as they are open on the sides.

Long Pants and Long Sleeve Shirt

Protection from sticks, branches, long grass, airborne objects, or anything that could possibly scrape your skin. The heavier the material, the better the protection.

Gloves

Gloves will provide protection to your hands from any debris or inclement weather. Choose a glove that provides a gripping surface as well as protection.

Boots/Ankle Protection

Choose a boot that protects the foot and ankle and can handle impact over rugged terrain. Choose a boot that has low heel and a good tread will help prevent your feet from slipping in wet or rugged conditions.

An XTV is NOT a Toy and Can Be Hazardous To Operate

First Aid and Survival

Prepare for the unexpected. Emergencies and accidents happen and are ever worse when you are not prepared for them. Below is a recommended list of items you should have before every ride:

1. Tools

Routine maintenance will generally eliminate the need for emergency repairs during your ride. Riding on rough terrain could cause some fasteners to loosen. Carrying the right tools can prevent down time. Below is a recommended list of tools to carry on your ride:

- a. Spark plug
- b. Spare parts
- c. Rope
- d. Tool kit
- e. Duct tape
- f. Headlight/Taillight bulbs

2. Water

Water is an important part of your ride regardless of the duration. Heat exhaustion and heat stroke can suddenly shorten your ride. If you become dehydrated, you may find yourself unable to safely operate your XTV.

3. Identification

If something happens to you while operating your XTV, emergency personnel will need to know who you are and who to call in the event of an emergency. It may be possible, you are unable to provide that information due to injury. Put identification in your pocket before you ride.

4. First Aid Kit/ Emergency Kit with Flashlight

Several items are recommended in your Emergency Kit including a *Flashlight*; *Matches* in the event you need to start a fire; *Flares* for signaling help; *First Aid Kit* to include bandages, tape, gauze, antiseptic spray, etc. if an injury should occur; *Money*.

5. Communication device - it may be necessary to make an urgent phone call.

6. Map/GPS

An XTV is NOT a Toy and Can Be Hazardous To Operate

Roll Over Protective Structures

On vehicles equipped with the Roll Over Protective Structure, also referred to as a ROPS, provides additional protection for the occupants in case the vehicle overturns, provided all occupants wear seat belts.

However, the ROPS also introduces additional hazards that have to be carefully weighed against the safety benefits of these devices:

- If your vehicle is equipped with a ROPS, always remember that your vehicle is now more top heavy. This reduces the vehicle's stability both on land and in the water. Therefore, always wear your seat belt when driving on land, but never when driving in the water. The increased instability and weight may mean that you will no longer be able to manoeuvre some slopes with a ROPS installed. Follow all weight restrictions and, as always, drive slowly and carefully.
- Be particularly careful when driving under trees, as low-hanging branches can upset your vehicle.
- Never place or carry anything on top of the ROPS.

The Roll Over Protective Structure (ROPS) provides roll over protection and lap belts for the driver and front seat passenger or for driver and front seat passenger and two passengers with the optional rear bench seat.

The ROPS design provides reasonable protection from injury in the event of a rollover. DO NOT rely on it to protect the occupants from irresponsible driving.

The ROPS (p/n 900-0040) has been designed to meet the test standards of SAE J2194: 2016 and ISO 5700: 2013.



WARNING

Seat belts must be properly adjusted and worn by all occupants at all times EXCEPT when operating in water. Never carry more people in the vehicle than there are seat belts for.

Articles must not be placed on top of the ROPS.

Use caution when travelling on uneven ground; the ROPS reduces vehicle stability.

No part of the ROPS shall be drilled, welded or altered in any way.

Do not exceed maximum gross vehicle weight.

Use caution when travelling tree-lined trails. Branches could be knocked down, causing injury to the vehicle occupants or damage to the vehicle.

FAILURE TO COMPLY WITH THE ABOVE COULD RESULT IN PERSONAL INJURY OR DEATH.



CAUTION

DO NOT use the ROPS as an attachment point for towing or winching your Argo.

Check fastener tightness annually. Inspect for and replace any damaged or worn parts of the ROPS and the seat belts.

Hangtags and Warning Labels

There are labels on all Aurora models which indicate operating hazards and provide special operating instructions. Information about the use of the holding brake system, the use of the vehicle in water, correct fueling procedures and placement of the floorpans has been provided on distinctive coloured labels fastened to the various locations on the Argo.

K2air Ontario Drive & Gear Limited
 1400 Hwy 7, Scarborough, Ontario, Canada M1V 4Y8

Product Number: _____
 Model: _____
 Engine: _____
 DOSE: _____

• EMISSION CONTROL INFORMATION •
 THIS EQUIPMENT MEETS U.S. EPA SVAP STANDARDS

Equipment Family: _____
 Fuel Type: _____
 Fuel Lines: _____

• MADE IN CANADA •

WARNING

- Hand brake must be applied to start engine.
- DO NOT shift F-N-R or High/Low levers unless the vehicle is at a full stop and the engine is at idle.
- Ensure parking brake is released before operating vehicle.
- Apply parking brake before exiting the vehicle.

WARNING
HOT

WARNING

IMPROPER USE OF THIS ENGINE CAN RESULT IN SERIOUS INJURY OR DEATH.
 LOCATE AND READ OPERATOR MANUAL. FOLLOW THE INSTRUCTIONS CAREFULLY.

SAFETY PRECAUTIONS:

- Do not drink or eat while operating.
- Do not drink or eat while operating.
- Do not drink or eat while operating.
- Do not drink or eat while operating.

WARNING:

- Do not drink or eat while operating.
- Do not drink or eat while operating.
- Do not drink or eat while operating.
- Do not drink or eat while operating.

WARNING

CAUTION:

- Shut engine off when refueling.
- Keep open flame away when refueling.
- Check for and clear up spilled fuel immediately.
- Tighten fuel cap securely.
- See Operator's Manual for recommended fuel additives.

WARNING/AVERTISSEMENT

MODEL / MODELS	VEHICLE LOAD CAPACITY / CAPACITE DE CHARGE DU VEHICULE	NO.	NO.
CAPACITY INCLUDES: - OPERATOR'S SEAT - OPERATOR'S FUEL - ALL EQUIPMENT - ACCESSORIES	DRY LOAD & SUPPLY		
	WET LOAD & SUPPLY		
EQUIPMENT HELD BY OCCUPANTS IS EXCLUDED FROM THIS CAPACITY. (EQUIPMENT ATTACHED TO VEHICLE IS EXCLUDED)	DRY LOAD & SUPPLY		
	WET LOAD & SUPPLY		
TIRE INFLATION / GOMPLEMENT DES PNEUS	REGULAR INFLATION / REG. INFLATION	17-18	18-19
	MAXIMUM INFLATION / MAX. INFLATION	20-21	21-22

WARNING

- Keep floor pans securely in place. Moving chains can cause severe personal injury.

Warnings



WARNING

POTENTIAL HAZARD

Failure to follow the age recommendations for this XTV.

WHAT CAN HAPPEN

If children use XTVs that are not recommended for their age, severe injury or death can result.

Even though a child may be within the age group for which an XTV is recommended, he or she may not have the skills, abilities, or judgment needed to operate the XTV safely and may be involved in a serious accident.

HOW TO AVOID THE HAZARD

Never allow anyone under 16 years of age to operate this XTV.
Never allow continued use of the XTV if he or she does not have the abilities to operate it safely.



POTENTIAL HAZARD

Operating this vehicle without proper instruction.

WHAT CAN HAPPEN

The risk of an accident is greatly increased if the operator does not know how to operate this vehicle properly in different situations and on different types of terrain.

HOW TO AVOID THE HAZARD

All operators of this vehicle must read and understand this Operator's Manual and all warning and instruction labels prior to operating this vehicle.

POTENTIAL HAZARD

Operating this XTV on paved surfaces.

WHAT CAN HAPPEN

The XTV tires are designed for off-road use only and are not for use on pavement. Paved surfaces may seriously affect the handling and control of the XTV and may cause the XTV to go out of control.

HOW TO AVOID THE HAZARD

Whenever possible, avoid operating the XTV on any paved surfaces including streets, parking lots, sidewalks, and driveways. If operating on paved surfaces is unavoidable, travel slowly (less than 10 mph) and avoid sudden turns and stops.

POTENTIAL HAZARD

Operating this XTV on public streets, roads, or highways.

WHAT CAN HAPPEN

You can collide with another vehicle.

HOW TO AVOID THE HAZARD

Never operate this XTV on any public street, road, or highway, even a dirt or gravel one. In many states it is illegal to operate an XTV on public streets, roads, or highways.



WARNING

Indicates a potential hazard that could result in a serious injury or death.

Warnings

POTENTIAL HAZARD

Operating this XTV after or while consuming alcohol or drugs.

WHAT CAN HAPPEN

Can seriously affect your judgment.
Can cause you to be slow to react.
Can affect your balance and perception.
Can result in an accident.

HOW TO AVOID THE HAZARD

Never consume alcohol or drugs before or while operating this XTV.



POTENTIAL HAZARD

Failure to inspect the XTV before operation.
Failure to properly maintain the XTV.

WHAT CAN HAPPEN

Increases the possibility of an accident or equipment damage.

HOW TO AVOID THE HAZARD

Always inspect the XTV every time you use it. Ensure it is safe operating condition.
Always follow the inspection and maintenance procedures and schedules described in this Operator's Manual.

POTENTIAL HAZARD

Operating this XTV at excessive speeds.

WHAT CAN HAPPEN

Increases the chance of losing control of the XTV, which can result in an accident.

HOW TO AVOID THE HAZARD

Always operate at a speed that is proper for the terrain, visibility, operating conditions, and your age and experience.

POTENTIAL HAZARD

Failure to use caution when operating this XTV on unfamiliar terrain.

WHAT CAN HAPPEN

You may encounter hidden rocks, bumps, or holes without enough time to react.
Could result in the XTV going out of control.

HOW TO AVOID THE HAZARD

Use caution when operating on unfamiliar terrain. Always be alert to changing terrain conditions.

**Never Operate Up or Down Hills
Steeper than 30°**

30° MAX



WARNING

Indicates a potential hazard that could result in a serious injury or death.

Warnings

POTENTIAL HAZARD

Operating this XTV without wearing an approved helmet, eye protection, and protective clothing.

WHAT CAN HAPPEN

Operating without an approved helmet increases your chances of a severe head injury or death in the event of an accident.

Operating without eye protection can result in an accident and increases your chances of a severe injury in the event of an accident.

Operating without protective clothing increases your chances of severe injury in the event of an accident.

HOW TO AVOID THE HAZARD

Always wear an approved helmet that fits properly.

You should also wear:

Eye protection (goggles or face shield)

Gloves

Boots

Long sleeved shirt or jacket

Long pants



POTENTIAL HAZARD

Improper handling of gasoline.

WHAT CAN HAPPEN

Gasoline can ignite and you could be burned. Gasoline is poisonous and can cause injury.

HOW TO AVOID THE HAZARD

Always turn off the engine when refueling.

Do not refuel right after the engine has been running and is still very hot.

Do not spill gasoline on the engine or exhaust pipe/muffler when refueling.

Never refuel while smoking, or while in the vicinity of sparks, open flames, or other sources of ignition such as the pilot lights of water heaters and clothes dryers.

POTENTIAL HAZARD

Operating on steep hills.

WHAT CAN HAPPEN

This XTV can overturn more easily on steep hills than on level surfaces.

HOW TO AVOID THE HAZARD

Never operate this XTV on hills too steep for the XTV or for your abilities.

Practice on smaller hills before attempting larger hills.

POTENTIAL HAZARD

Failure to use caution when operating this XTV on rough, slippery, or loose terrain.

WHAT CAN HAPPEN

You may lose traction or control, which could result in an accident.

HOW TO AVOID THE HAZARD

Do not operate this XTV on rough, slippery, or loose terrain until you have learned and practiced the skills necessary to control this XTV on such terrain.



WARNING

Indicates a potential hazard that could result in a serious injury or death.

Warnings

POTENTIAL HAZARD

Climbing hills improperly.

WHAT CAN HAPPEN

You may lose control, which could result in an accident.

HOW TO AVOID THE HAZARD

Always follow proper procedures for climbing hills.

Always check the terrain carefully before you start up any hill.

Never climb hills with slippery or loose surfaces.

Never open the throttle suddenly. The XTV may flip over backwards.

Never go over the top of any hill at high speeds. An obstacle, sharp drop, or another vehicle or person may be on the other side.

POTENTIAL HAZARD

Failure to use caution in turns; turning too sharp or aggressive.

WHAT CAN HAPPEN

You may lose control, which could result in an accident.

HOW TO AVOID THE HAZARD

Always follow proper procedure for turning. Practice turning at slower speeds before attempting to turn at faster speeds. Do not attempt to turn at excessive speeds or too sharp for the conditions and for your experience level.

POTENTIAL HAZARD

Going down a hill improperly.

WHAT CAN HAPPEN

You may lose control, which could result in an accident.

HOW TO AVOID THE HAZARD

Always follow proper procedures for going down hills.

Always check the terrain carefully before you start down any hill.

Never go down a hill at high speeds.

Avoid going down a hill at an angle that would cause the XTV to lean sharply to one side.

Go straight down the hill where possible.

POTENTIAL HAZARD

Operating the XTV with improper tires or improper or uneven tire pressure.

WHAT CAN HAPPEN

You may lose control, which could result in an accident.

HOW TO AVOID THE HAZARD

Always use the size and type of tires specified in this Operator's Manual.

Always maintain proper tire pressure.



WARNING

Indicates a potential hazard that could result in a serious injury or death.

Warnings

POTENTIAL HAZARD

Stalling, rolling backwards, or improperly dismounting while climbing a hill.

WHAT CAN HAPPEN

You may lose control, which could result in an accident.

HOW TO AVOID THE HAZARD

Use proper gear and maintain steady speed when climbing a hill.

If you lose all forward momentum:

Apply the brakes.

Engage the parking brake after you are stopped.

If you begin rolling backwards:

Gradually apply the brakes while rolling backwards.

When fully stopped, engage the parking brake.

Dismount on the uphill side or to a side if pointed straight uphill.

POTENTIAL HAZARD

Operating the XTV in deep or fast flowing water.

WHAT CAN HAPPEN

Tires may float, causing loss of traction and loss of control, which could result in an accident.

HOW TO AVOID THE HAZARD

Never operate the XTV in fast flowing water.

Remember that wet brakes may have reduced stopping capability.

Test the brakes after exiting the water. If necessary, apply the brakes several times to dry out the brake pads.

POTENTIAL HAZARD

Skidding or sliding.

WHAT CAN HAPPEN

You may lose control, which could result in an accident.

HOW TO AVOID THE HAZARD

Learn to safely control skidding or sliding by practicing at slow speeds on level, smooth terrain.

On extremely slippery surfaces, such as ice or snow, go slow and use caution in order to reduce the chance of skidding or sliding out of control..

POTENTIAL HAZARD

Operating this XTV with improper modifications.

WHAT CAN HAPPEN

Improper installation and improper use of accessories or modification of the XTV may cause changes in operation or handling which, in some situations, may lead to an accident.

HOW TO AVOID THE HAZARD

Never modify this XTV through improper installation or improper use of accessories.

All parts and accessories added to this XTV should be components designed for use on this XTV and should be installed and used according to instructions.



WARNING

Indicates a potential hazard that could result in a serious injury or death.

Warnings

POTENTIAL HAZARD

Improperly operating over obstacles.

WHAT CAN HAPPEN

You may lose control, which could result in an accident.

HOW TO AVOID THE HAZARD

Before operating on unfamiliar terrain, check for obstacles.

Never attempt to operate over large obstacles, such as large rocks or fallen trees.

When going over obstacles, always follow proper procedures.

POTENTIAL HAZARD

Improperly crossing hills or turning on hills.

WHAT CAN HAPPEN

You may lose control, which could result in an accident.

HOW TO AVOID THE HAZARD

Avoid crossing the side of hill or turning on a hill whenever possible. Never attempt to turn the XTV around on any hill until you have mastered the turning technique as described in this Operator's Manual. Practice first on level ground.

If you must cross the side of a hill or turn on a hill: Always follow proper procedures described in this Operator's Manual.

Avoid hills with slippery or loose surfaces.

POTENTIAL HAZARD

Starting or running engine in a closed area.

WHAT CAN HAPPEN

Exhaust fumes are poisonous and may cause loss of consciousness and death within a short period of time.

HOW TO AVOID THE HAZARD

Always operate your XTV outdoors or in an area with adequate ventilation.

POTENTIAL HAZARD

Hot exhaust system.

WHAT CAN HAPPEN

Someone coming in contact with the exhaust system during or after operation could be burned.

HOW TO AVOID THE HAZARD

Do not touch the hot exhaust system.

Do not park the XTV in a place where others might be likely to come in contact with the exhaust system.

POTENTIAL HAZARD

Overloading this XTV.

WHAT CAN HAPPEN

Could cause changes in XTV handling, stability and braking which could lead to an accident or injury.

HOW TO AVOID THE HAZARD

Never exceed the stated maximum weight capacity for this XTV.



WARNING

Indicates a potential hazard that could result in a serious injury or death.

Warnings

POTENTIAL HAZARD

Operating in areas where you might not be seen by other off-road vehicles.

WHAT CAN HAPPEN

You may be in a collision which may result in personal injury.

HOW TO AVOID THE HAZARD

Always mount a caution flag on the XTV to make you more visible.
Watch carefully for other XTV riders and other vehicles.

POTENTIAL HAZARD

Turning improperly.

WHAT CAN HAPPEN

XTV could go out of control, causing a collision or overturn.

HOW TO AVOID THE HAZARD

Always follow proper procedures for turning as described in this Operator's Manual.
Practice turning at low speeds before attempting to turn at faster speeds. Do not turn at speeds too fast for your skills or the conditions.
Do not turn at excessive speeds.

Wind Chill Factor

Why does it feel much colder outdoors on a windy day than when there's no wind, especially in winter?

The cooling effect of the wind makes it feel that it's colder than it really is. This combined effect of wind and low temperature is known as the "wind chill factor".

Argo operators should be aware of the wind chill factor. Dress warmly and make sure exposed skin is protected. Pay particular attention that young passengers are properly "bundled up" with their hands and faces well protected.

WIND CHILL									
Wind Speed									
km/h	8	16	24	32	40	48	56	64	
Actual Temp.(C)									Gradually
0	-2	-8	-11	-14	-16	-17	-19	-19	Increasing
-5	-7	-14	-18	-21	-23	-25	-26	-27	Danger
-10	-12	-20	-25	-28	-31	-33	-34	-35	Dangerous
-15	-18	-26	-32	-35	-38	-40	-42	-43	
-20	-23	-32	-38	-43	-46	-48	-50	-51	
-25	-28	-38	-45	-50	-53	-56	-57	-59	Extremely
-30	-33	-45	-52	-57	-61	-63	-65	-67	Dangerous
-35	-39	-51	-59	-64	-68	-71	-73	-75	
-40	-44	-57	-65	-71	-75	-79	-81	-83	
-45	-49	-63	-72	-78	-83	-86	-89	-90	
-50	-54	-69	-79	-85	-90	-94	-96	-98	

SECTION 3

Specifications

Aurora Pro 950 XT 8x8

ENGINE AND DRIVE

Engine	VX 950
Displacement	993 cc
Bore x Stroke (mm)	85.5 x 86
Cylinder Arrangement	V-twin, air cooled, OHV EFI
Engine Idle RPM	1100 +/- 50 (no load)
Wide Open Throttle Maximum RPM	4000 +/- 150 (no load)
Starting System	Electric
Lubrication System	Full Pressure Lubrication System with Oil Cleaner
Electrical System	12V
Alternator	50A
Transmission	Admiral 6.2 w/APS
Clutch	ITC (Instant Torque Clutch)
Steering / Brakes	Argo Progressive Steering (APS) Hydraulic steering / stopping disc brakes
Drive Chains	Double RC 50 and Single RC 60 roller chain
Battery Type	12V 30 Ah
Spark Plug Type	NGK BPR4ES
Spark Plug Gap	.0030 in (.08 mm)
Brake Type	Hydraulic
Air Filter	Low Profile Paper
Clutch Type	Centrifugal
Fuel Delivery	Electric High Pressure Fuel Pump

CHASSIS

Length (Overall)	126 in (3,200 mm)
Width (Overall)	60 in (1,524 mm)
Height (Overall)	77 in (1,956 mm)
Weight (Overall)	1,845 lbs (837 kg)
Minimum Ground Clearance	10 in (25.4 cm)
Tires	Steel Airlock - ARGO XT119 25x12-9
Tire Pressure:	2.5 to 3.5 psi (17 to 24 kPa)

Aurora Pro 950 XT 8x8

MISCELLANEOUS

Fuel (Recommended)	87 Octane Regular Unleaded
Gas Tank Capacity (Rated)	8.5 gal (32.2 L)
Engine Oil (Recommended)	Argo 5W40 Synthetic
Engine Oil Capacity	w/Filter 2.4 qts.(2.3 L)
Transmission Oil (Recommended)	Argo 75W90 Synthetic
Transmission Capacity	1.3 qt (1.2 L)
Brake Fluid	DOT 4
Chain Lube	ARGO PTFE Chain Lube
Grease	Argo NLGI #2 Lithium Grease
Headlight	Halogen
Tail Light / Brake Light	LED
Seating Capacity	Land: 6 Water: 2
* Load Capacity	Land: 705 lb (320 kg) Water: 505 lb (229 kg)
Towing Capacity	1800 lbs (816 kg)
<p>* - Vehicle capacity includes occupants, cargo, fuel, and all additional accessories. Capacity for occupants and cargo is reduced by the weight of extra accessories installed on your vehicle. Load capacity on water is reduced by 100 lbs. if your XTV is equipped with optional smaller 24x10.00-8 tires when the standard specification would include 25x12.00-9. The reduced buoyancy could cause the XTV to become swamped and sink, causing injury or drowning to the driver and passengers.</p>	
<p>Specifications subject to change without notice.</p>	

SECTION 4

Description and Identification

Identification and Location of Controls

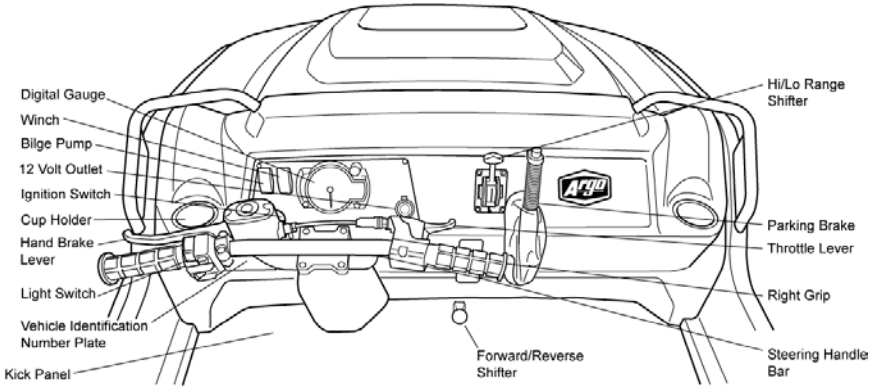

Key Switch

The key switch will turn electrical circuits “ON” and “OFF”. Rotate the key clockwise to the “ON” position for the circuits to power up. Rotate the key counter-clockwise to turn the circuits “OFF”.

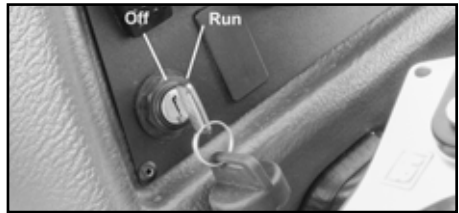

Throttle Control

Vehicle speed is controlled by the throttle lever. To increase vehicle speed, squeeze the throttle lever towards the hand grip. To decrease vehicle speed, release the throttle lever so the engine returns to idle.

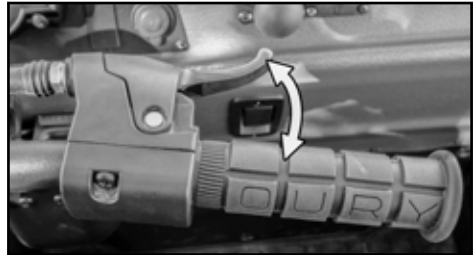

Starter Button

Depress the starter button to start the engine. Key switch must be in the “ON” position and brake lever must be compressed to activate.



Control Functions

Emergency Stop Switch

Release the throttle lever. Slide the emergency stop switch to the “OFF” position.

Turn ignition key switch to the “OFF” position.



Headlights

High/Low beam headlights are operated through the hand control switch on the left steering bar. The switch controls “Off” “LO” and “HI” beam. To operate the lights, slide the switch to the desired position.



CAUTION

Do not leave the lights on for any length of time when the engine is not running. Leaving them on will drain the battery.

Always turn the ignition switch to the 'OFF' position when turning off the engine.

Avoid frequent starting of the engine and extensive idling. Both will lead to a drain of the battery because the electrical draw may be greater than the charging rate at engine idle.

Bilge Pump Switch

The bilge pump switch will turn the bilge pump “ON” and “OFF”. Key switch must be in the “ON” position to activate.

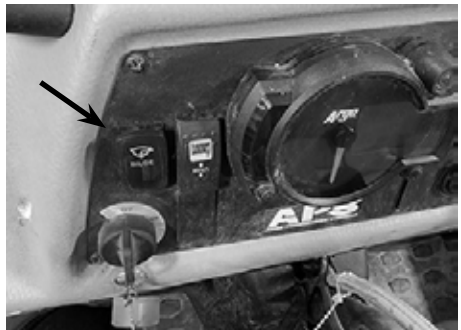

Control Functions

Dual USB Outlet

The dual USB outlet on the dash has a 5v / 2.1 amp output.



Parking Brake System

When in use, the parking brake system keeps the wheels locked in the full braking position.

To apply the parking brake system:

1. Pull the parking brake lever rearward until the parking brake caliper holds the vehicle in place. An indicator light on the display gauge will illuminate indicating the parking brake is applied.

To release the parking brake system:

1. Pull rearward on the parking brake lever and then press the button on the top of the parking brake lever to release the ratchet mechanism, then move the parking brake lever forward until the parking brake caliper fully releases. The indicator light on the display gauge will go out.

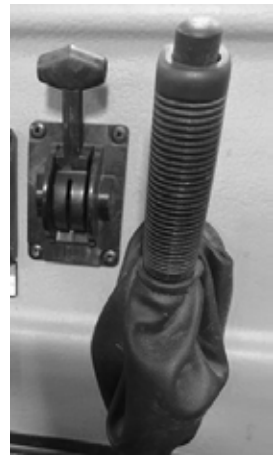

WARNING

Always engage parking brake before exiting the vehicle.

Control Functions

Hand Brake

When compressed, the hand brake will apply pressure to the braking calipers to slow and stop the vehicle.

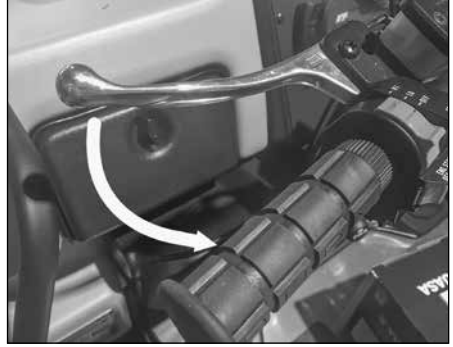

CAUTION

Excessive braking can create brake pads to get hot and create excessive heat which may affect braking performance.

Shifting Transmission



CAUTION

DO NOT CHANGE TRANSMISSION GEARS WHILE THE VEHICLE IS MOVING. To change gears, bring the vehicle to a complete stop, let the engine idle down completely, engage hand brake and move the shift lever to the selected gear.

Changing Transmission Gears

The “Admiral” transmission is equipped with two shift levers. The Forward/Neutral/Reverse shift lever is located through the lower kick panel and moves side to side. Forward gear is located to the left of neutral and reverse gear to the right of neutral. PLEASE OBSERVE CAUTIONS.

The High/Low range shift lever is located in the upper dash. High range is selected when the lever is in the up position and should be used for most driving conditions. Low range is selected when the lever is in the down position.



CAUTION

Do not attempt to move the gear shift from the neutral (N) starting position until the engine idles down completely. If the engine idle speed is too high, the transmission will grind during gear engagement.



Control Functions

Instrument Cluster

Argo Aurora's are equipped with an LCD instrument cluster.

The LCD cluster displays battery voltage, hour meter, odometer, speedometer, tachometer and fuel level. There are indicator lights for parking brake, low oil pressure, and diagnostic light.

Gauges can be calibrated in km or miles both in speed and distance.

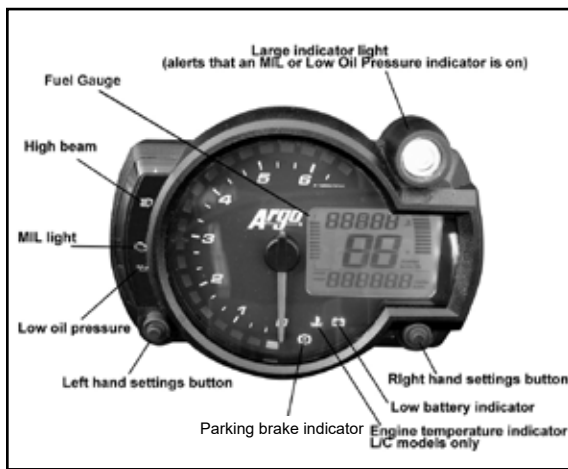

Operator Settings

Operator may program:

- digital display brightness
- kilometers/miles
- time/clock

To enter program settings, hold both right side and left side settings buttons simultaneously for 3 seconds.

Digital display brightness flashes. Cycle through brightness levels with right side settings button. When desired brightness level is achieved, push left side settings button. Miles/Kilometers flashes. Use right side settings button to cycle between miles and kilometers. When desired setting is met, push left side button, clock settings flashes. Set clock. Under normal operating conditions the operator may use the right side settings button to cycle through:

- trip A
- trip B
- hours of operation
- max recorded RPM and Speed history.

Control Functions

Brakes And Steering



CAUTION

Do **NOT** over steer. Avoid the tendency to push or pull harder on the steering system if the vehicle is not responding as expected. Once the steering brakes have been locked, pushing or pulling harder on the steering system will not increase the turning capacity of the vehicle. Damage may occur to the steering system as a result of over-steering.

The handlebar is used to turn the vehicle when it is moving in forward or reverse. Pulling back on the right side of the handlebar while pushing on the left side of the handle bar, causes the vehicle to turn right. Pulling back on the left side of the handlebar while pushing on the right side causes the vehicle to turn left. To stop the vehicle, squeeze the hand brake lever located on the left handlebar.

The ARGO is a skid steer vehicle. During a turn, the rear of the vehicle swings outward as the vehicle pivots on the front tire on the inside of the turn. To make a right hand turn, the rear of the vehicle skids out to the left. To make a left hand turn, the rear of the vehicle skids out to the right.



WARNING

When turning, the back of the vehicle swings to the opposite direction of the turn. Always take care to avoid impacting foreign objects with the rear of the vehicle. Serious injury or death can result.

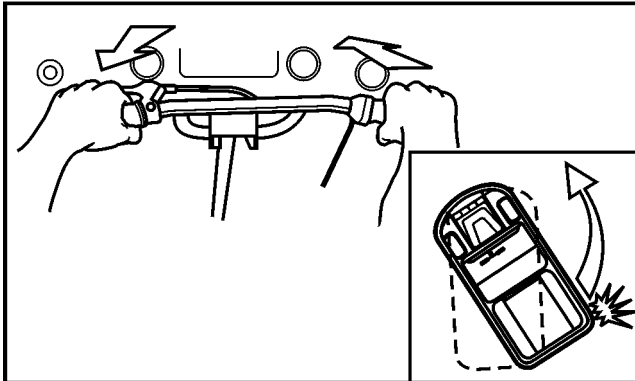

Making a left hand turn.

SECTION 5

Getting to Know Your XTV

Getting To Know Your XTV

This XTV is for recreation use. This section, riding your XTV, provides general XTV riding instructions for recreational riding. The skills and techniques described in this section, however, are appropriate for all types of riding. Riding your XTV requires special skills acquired through practice over a period of time. Take the time to learn the basic techniques well before attempting more difficult maneuvers.

Riding your new XTV can be a very enjoyable activity, providing you with hours of pleasure. But it is essential to familiarize yourself with the operation of the XTV to achieve the skill necessary to enjoy riding safely. Before you begin to ride, be sure you have read this Operator's Manual completely and understand the operation of the controls. Pay particular attention to the safety information and special safety messages. Please also read all caution and warning labels on your XTV.

Before Riding

Before operating the XTV, read and understand the "Safety Information" section carefully.

You need to prepare before riding. This includes getting proper instruction, making sure your XTV is in good operating condition, and learning some basic safe-riding rules.

Rider Preparation - Age Recommendation

The minimum age for this XTV model is 16. For safety, never let anyone under 16 years old operate this vehicle.

Pre-operation Checks

Always inspect your XTV each time you use it to make sure the XTV is in safe operating condition. Perform the pre-operation checks listed in this manual. Always follow the inspection and maintenance procedures and schedules described in the Operator's Manual.

Safe Riding Rules

Please note that the safe Riding Rules apply to all XTV riders. Even if you are an experienced rider, or after you become one, continue to follow these guidelines for your own safety and enjoyment.

Protective Apparel

Always wear an approved helmet when riding your XTV. You should also always wear goggles or a face shield, gloves, boots, a long-sleeved shirt or jacket, and long pants.

Load Capacity Limits

There are limits to how much weight can be carried on your XTV. See Load Capacity section in the Specifications section. Modifying your XTV, using non-standard equipment or riding on terrain that is not flat and smooth could further reduce these limits.

Never exceed the stated load capacities for this vehicle. Cargo should be properly distributed and securely attached. Reduce speed when carrying cargo or pulling a trailer and allow greater distance for braking.

Getting To Know Your XTV



CAUTION

Vehicle capacity includes occupants, cargo, fuel, and all additional accessories. Capacity for occupants and cargo is reduced by the weight of accessories installed to your vehicle. Refer to accessory chart in Specification Section for accessory weights.

Some models come with accessories included. Available vehicle capacity must be reduced if your vehicle is equipped with any additional accessories. Reduce the available capacity by the total weight of additional accessories fitted to your vehicle.



WARNING

Load capacity on water is reduced by 100 lbs. if your XTV is equipped with optional smaller 24x10.00-8 tires when the standard specification would include 25x12.00-9. The reduced buoyancy could cause the XTV to become swamped and sink, causing injury or drowning to the driver and passengers.



WARNING

Do NOT use an XTV on water or frozen bodies of water when equipped with a snow plow. The increased weight of the snow plow out front will make the XTV unstable and could cause the vehicle to capsize, causing injury or drowning to the driver and passengers.

Accessories

Genuine ARGO accessories have been specifically designed for and tested on this vehicle. Because ARGO cannot test all other accessories, you are personally responsible for properly selecting, installing, and using non- ARGO accessories.

1. Carefully inspect the accessory to make sure it does not block any lights, reduce ground clearance, or limit steering travel or other controls.
2. Make sure the accessory does not interfere with your ability to shift body position on the seat or operate hand controls.
3. Do not add electrical equipment that will exceed the vehicle's electrical system capacity. A failed fuse could cause a loss of lights or engine power.

No Modifications

Modifying this XTV or removing original equipment may render the vehicle unsafe or illegal. Spark arresters and mufflers are required in most areas. Don't modify your exhaust system or emission control system components. Remember, excessive noise bothers everyone and creates a bad image for off-road vehicles.

For Off-Road Use Only

This XTV is designed and manufactured for off-road use only.

Do not ride in areas posted "no-trespassing".

Do not ride on private property without getting permission.

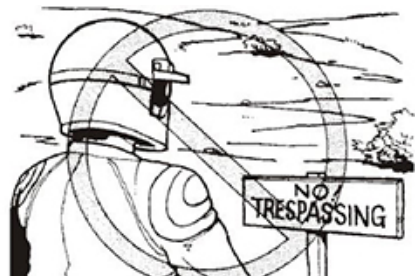

Getting To Know Your XTV

Environment

The environment that you will operate your XTV in is often harsh and sometimes dangerous if you don't take proper precautions.

Weather

You need to consider the weather when you participate in an outdoor activity such as riding an XTV. It is dangerous to ride your XTV when the weather is bad or could potentially become bad. Before starting out on your XTV, check the weather forecast for the location and duration of your ride.

Terrain

Always pay close attention to the terrain you're on, even if it is in an area familiar to you. Do not assume that the landscape you're used to doesn't change. Changes to landscape can happen at any time; fences can be constructed and excavations dug in a short period of time. Weather, climate, and development take their toll as well as erosion and other changes that can affect your XTVs ability to ride smoothly and securely.

Because terrain can constantly change in configuration, you may not know how it has changed until you get there. Whether it's familiar or not, check out your surroundings before and during your ride.

Night Riding

It is best to avoid riding your XTV at night when visibility is limited. With little to no light, it is difficult to see what is around you.

If you must ride at night, proceed slowly and never ride at a speed that would prevent you from reacting to something that could come up in the limited view of your XTVs headlamps.

Paved Surfaces

Avoid riding your XTV on paved surfaces. Your XTV was not designed for use on pavement and its handling will become more difficult and unpredictable than when riding on non-paved surfaces.

Trail Riding

Use sound judgment when trail riding with your XTV. You should only ride on trails that suit your riding ability.

Make yourself visible to others by using your XTVs headlights and taillights. If you stop, pull completely off the trail in a way to protect yourself, your XTV, and the environment.

Sloped trails (trails that slant to allow rain to run off) make trail riding more challenging. To ride on sloped trails, keep your weight shifted towards the uphill of the slope. Proceeding slowly with your weight shifted towards the slope will help you from sliding off the trail.

Be aware of the rules and the laws that govern the area in which you will be riding your XTV. Learn which trails you can legally and safely ride on and who else might be on those trails. Be aware of the signs posted in the areas you ride that would designate trail types and restrictions.

Turning Your XTV



WARNING

Always follow proper procedures for turning as described in this Operator's Manual. Practice turning at low speeds before attempting to turn at faster speeds. Do not turn at speeds too fast for your skills or the conditions. XTV could go out of control causing a collision or overturn.

Leaning, Weight Shift, and Balance

Use extreme CAUTION when negotiating inclines with a loaded vehicle. Heavy loads and high loads decrease the stability of the vehicle and may cause it to roll. Be prepared to shift occupant weight and load forward or have passengers get out of the vehicle to climb an incline. Pay attention to the XTV's handling.

Wide Turns

If you don't understand turning techniques, you can lose control of your XTV by losing traction, plowing, or tipping. Use this riding method for wide turns:

1. Slow down as you approach the turn.
2. Use the principles of leaning, weight shifting, and balancing.
3. Gradually increase your speed as you come out of the turn.

Sharp Turns

After mastering wide turns, practice the advanced skill of sharp turns. Use this riding method for sharp turns:

1. Slow down as you approach the turn.
2. Use the principles of leaning, weight shifting, and balancing.
3. You may have to lean into the turn more than you do in a wide turn.
4. If shifting your weight and balance are not enough to keep the XTV tires on the ground, straighten out the handlebars as much as you can.
5. Gradually increase your speed as you come out of the turn.

Quick Turns

Quick turns are the most difficult turns, and should only be attempted after you have become very familiar with the handling characteristics of your XTV. Use this riding method for quick turns:

1. Slow down as you approach the turn.
2. Turn the handlebars, shift your weight, and balance at the same time as you enter the turn (use the principles of leaning, weight shifting, and balancing).
3. Follow your weight shift with slight acceleration.
4. For multiple turns, repeat this movement as needed.

Getting To Know Your XTV

Climbing Uphill



WARNING

Climbing hills improperly can cause overturns or loss of control. Use proper riding techniques described in this Operator's Manual.

Use extreme caution when riding your XTV on hills. Use this method for riding uphill:

1. Slightly accelerate before you start to climb a hill and maintain a steady pace.
2. Lean as far forward as possible.
3. If you lose speed, carefully apply more throttle. Be prepared to release the throttle so your tires do not lift.
4. If you lose forward momentum and the terrain permits, back down the hill.



WARNING

Never accelerate or brake suddenly while driving up or down a hill. Sudden acceleration or braking can cause the vehicle to roll over, causing serious personal injury or death

Never attempt to turn the vehicle around on a steep hill or grade. Turning the vehicle around on a hill can result in the vehicle to roll over.

Approach the hill head-on to minimize the possibility of sliding sideways or rolling over. Accelerate slowly to prevent loss of traction. When traction is lost, the vehicle may slide sideways or backwards. If this occurs, apply the brakes gently and evenly to stop the slide. Allow the vehicle to coast to the bottom of the hill by carefully releasing the brakes.

Try to avoid steep hills. When a steep hill cannot be avoided, be prepared to shift occupant weight forward, or have them get out of the vehicle to prevent the vehicle from rolling over. As a general rule, driving up a steep hill greatly increases the possibility of rolling over.

Riding Down Hill



WARNING

Going down a hill improperly could cause overturns or loss of control. Always follow proper procedures for going down hills as described in this Operator's Manual.

Success in riding downhill depends on how familiar and skilled you are with using your brakes. Use care and balance braking force and downhill speed so you don't lose control. Use this method for riding downhill:

1. Do not shift the XTV into neutral ("N").
2. Lightly apply the brakes and use very little throttle.

Getting To Know Your XTV

Approach the hill head-on to minimize the possibility of sliding sideways or rolling over. Gently apply the brakes to control downward vehicle speed. Do not abruptly apply the brakes while traveling downhill as sudden braking may cause the vehicle to roll over. Continuous or excessive use of the brakes while going downhill can overheat the brake pads causing loss of braking force. Select low range and keep the engine speed up just enough to keep the clutch engaged on the sides of the belt.

Crossing a Slope



WARNING

Improperly crossing hills or turning on hills could cause loss of control or cause the XTV to overturn.

Side-hilling requires advanced XTV riding skills as the terrain can be difficult and unpredictable. Whether your skills are advanced or not, try to avoid this kind of riding. If you are in a situation where you absolutely have to side-hill on your XTV, use this riding method:

1. Keep the XTV speed low and consistent.
2. Shift all your body weight to the uphill side of the seat.
3. Steer as if you are driving into the hill.
4. If your XTV feels like it may tip over, turn the handlebar downhill.

Angle of Operation



CAUTION

When operating any Argo vehicle on an angle, (up and down inclines or across uneven terrain that causes the vehicle to tilt in any direction) the engine oil level and fuel delivery to the engine is affected. Damage to the engine may occur.

If the engine oil level falls below the oil pump intake, damage may occur because of inadequate lubrication. To avoid engine damage:

- Do not operate the vehicle continuously on angles or inclines that are greater than 30° in any direction.
- Make sure the engine oil level is near the "F" (full) mark.

The engine may also starve for fuel in the angle of operation is excessive. An engine starved for fuel is likely to sputter, hesitate, or stop. This can lead to loss of control. To prevent this, do not operate the vehicle on slopes greater than 30°.

Swerving

Swerving is an emergency maneuver required to avoid an obstacle, but is similar to a quick turn. Swerving differs as a quick turn involves slight acceleration during the turn. Do not accelerate if you swerve to maintain better control of your XTV. If you are in a situation where you feel you must swerve, use this riding method:

1. Slow down as you approach the obstacle.
2. Turn the handlebar, and at the same time, shift your weight and balance as you swerve. Use the principles of leaning, weight shifting, and balancing.
3. Avoid using the brakes until the obstacle avoidance swerve is complete and you have regained full control of your XTV.

Getting To Know Your XTV

Riding Over Rough Terrain



WARNING

Riding improperly over obstacles could cause loss of control or a collision. Before operating in a new area, check for obstacles. Never attempt to ride over large obstacles, such as large rocks or fallen trees. When you go over obstacles, always follow proper procedures as described in the Operator's Manual.

Crossing obstacles is dangerous, and even experienced XTV riders should avoid this practice if possible. Riding over logs, rocks, and ruts means you must combine all the active riding skills into one big motion. Your XTV will respond differently for different obstacles (logs, rocks, etc.), but these are general guidelines for overcoming two-track (both tires contacting the obstacle at the same time) obstacles.

1. Keep the XTVs speed very low - less than 5 MPH.
2. Approach the obstacle head-on.
3. Apply a slight amount of throttle when the front tires make contact with the obstacle.
4. Lean forward and release the throttle when the front tires clear the obstacle.
5. Keep your body loose to absorb any shock from going over the obstacle.
6. If the XTV begins to tip, shift your weight to maintain balance.

Sliding and Skidding



WARNING

Skidding or sliding improperly may cause you to lose control of this XTV. You may also regain traction unexpectedly, which may cause the XTV to overturn.

Care should be used when riding on loose or slippery surfaces since the XTV may slide. If unexpected and uncorrected, sliding could lead to an accident.

If the wheels of your XTV start to slide sideways, control can usually be regained by steering in direction of the slide. Applying the brakes or accelerating is not recommended until you have corrected the slide.

With practice, over a period of time, skill at controlled sliding can be developed. The terrain should be chosen carefully before attempting such maneuvers since both stability and control are reduced.

Bear in mind that sliding maneuvers should always be avoided on extremely slippery surfaces, such as ice, since all control may be lost.

Crossing Roads

Use extreme caution while crossing a road, avoid if at all possible. If you must cross a road:

1. Stop completely before crossing a road.
2. Check both directions for oncoming traffic.
3. NEVER attempt to cross a road or intersection at a blind crossing.
4. Drive straight across to the opposite side.
5. Allow plenty of time to safely cross the road.
6. Know your state and local laws. It is illegal to cross public roads in some places.

Getting To Know Your XTV

Cold Weather Operation

NOTE: Ensure all control levers operate as intended.



WARNING

For your personal safety, it is important to wear the proper type and amount of cold-weather clothing according to the coldest anticipated temperatures.

1. With the transmission in neutral (“N”) and the brake lever lock released, move the XTV forward and backward to ensure the wheels roll freely. If the XTV does not move, the tires may be frozen to the ground or the brake pads may be frozen to the rotors or drums.
2. If the tires are frozen to the ground, pour warm water around them to melt any ice around the tires.



CAUTION

Before operating, manually move the XTV forward and backward to ensure the wheels roll freely.

3. If the brakes are frozen, move the XTV to a warm location to thaw out the brakes.



WARNING

For your personal safety, do not attempt to free frozen brakes by pouring warm water on the brakes.

NOTE: After the brakes have thawed, dry them by compressing the brake lever several times while riding slowly.

NOTE: After riding through snow, slush, water or mud, it is recommended to dry the brake system before parking the XTV.



WARNING

For your personal safety, go slow and be extra careful while riding on snow or ice-covered terrain. Always be alert to the changing terrain while operating the XTV.

Parking

Parking requires following the previous rules of braking; then:

1. When the XTV comes to a complete stop, shift XTV into the “N” (Neutral) position.
2. Stop the engine using the engine stop switch located on the handlebar.
3. Turn the ignition switch to the “OFF” position.
4. Engage the parking brake.

Reversing

Remember, it is difficult to see behind you as you back up your XTV.

1. Proceed slowly, using a slight amount of throttle.
2. Keep the handlebar straight.
3. Avoid backing down hills; use a U-turn or a K-turn to turn around.

Getting To Know Your XTV

Braking

Practice starting and stopping at slow speeds. Gradually work up to faster starts and stops.

1. Steer straight ahead. Close the throttle completely, remove your finger from the throttle lever.
2. To apply brakes, compress the hand brake lever located on the handlebar.

Gradually increase the lever pressure as you feel the brakes slowing your speed. The pressure used depends on your speed and the condition of the terrain you are riding. Slick, slippery or muddy ground requires a more gentle braking.

Pulling the brake lever too hard may cause the wheels to skid or slide out of control. If this happens, release all pressure on the lever immediately. Steer straight ahead to regain control. Then gently reapply the brakes.

Extreme braking may cause the wheels to lock, reducing control of the XTV.

When possible, reduce speed or brake before entering a turn. Closing the throttle or braking in mid-turn may cause wheel slippage which will reduce control of your XTV.

Never hold the brake and accelerate at the same time. This will cause the brake system to overheat.

Parking on a Slope

1. Bring the XTV to a complete stop by applying the brakes.
2. Stop the engine.
3. Engage the parking brake.
4. With the brake applied, shift XTV into the “F” (Forward) position.



WARNING

POTENTIAL HAZARD

Parking on a hill or other incline.

WHAT CAN HAPPEN

XTV could roll out of control, increasing the risk of an accident or injury.

HOW TO AVOID THE HAZARD

Whenever possible, avoid parking on hills or other inclines. If you must park on an incline, shift the XTV into the “F” (Forward) position. Apply the parking brake, and block the front and rear wheels with rocks or other objects.

Do not park the XTV at all on hills that are so steep you could not walk up them easily.

Stopping the Engine

To stop the engine, slide the emergency stop switch to the “OFF” position or turn the ignition switch key to the “OFF” position.

NOTE: If you stop your XTV by turning the emergency stop switch to the “OFF” position, be sure to turn the ignition switch to the “OFF” position to prevent battery discharge.

Getting To Know Your XTV

Crossing Through Shallow Water



WARNING

Operating this vehicle through fast flowing water can lead to loss of control or an overturn. To reduce your risk of drowning or other injuries, use care when crossing through water.

All models of the ARGO are amphibious and capable of traversing calm water. Special operating procedures and safety precautions must be observed before entering the water and during amphibious operation.

The XTV can be used to cross slow moving or shallow water. Before entering the water, choose your path carefully. Enter where there is no sharp drop off, and avoid rocks or other obstacles, which may be slippery or upset the XTV. Drive slowly and carefully.

Test your brakes after leaving the water. If necessary, apply them several times to let the friction dry out the linings. Do not continue to ride your XTV without verifying that you have regained proper braking ability.



WARNING

Wet brakes may have reduced stopping ability, which could cause loss of control.

Amphibious Operation - General



WARNING

ARGO vehicles may sink if they fill with water. If water starts entering the vehicle, immediately turn on the bilge pump and head to the nearest shore. Be prepared to abandon the vehicle if it appears that the vehicle will fill with water before you reach the shore. Be especially cautious when operating a loaded vehicle (cargo and/or passengers) in water. Observe the capacity limits.

NOTE:

Always observe the recognized rules of boating while traveling in water.

Drain Plugs

1. Drain plugs are accessible from the outside of the vehicle. Make sure both drain plugs in the rear of the lower body are in place and properly tightened. To install, locate the drain plugs at the rear of the vehicle and thread each drain plug in a clockwise direction into the plug fitting ensuring a snug fit. Check the O-ring on drain plug periodically. When removed, each drain plug remains attached to the hole opening to prevent loss or misplacement of the plug while the vehicle is draining.



Location of rear drain plugs.

Getting To Know Your XTV

2. Visually check the lower body of the vehicle for cuts, punctures or holes that will allow water to enter the vehicle.
3. Make sure that any cargo in the rear of the vehicle is evenly distributed.
4. Periodically inspect the outer bearing flange and gaskets of each axle to ensure they are water tight. If there are signs of water leaking into the lower body, take corrective action before entering water again. Make sure there is sufficient grease in the bearing flange and that the grease seal is in good condition.

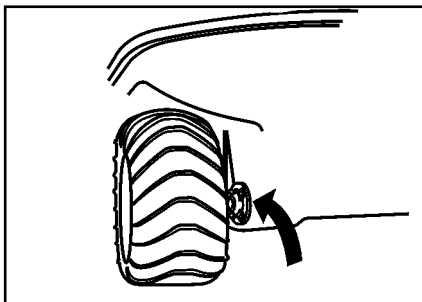

Outer bearing flange sealing area.

NOTE:

Always observe the recognized rules of boating while traveling in water.

Use caution and good judgement when entering water. Drowning can occur even in shallow water. Watch for obstacles under the water that could destabilize or upset the vehicle and may cause occupants to be ejected from the vehicle. Make sure all persons in the vehicle are wearing approved life jackets or Personal Flotation Devices.

All ARGO vehicles are self-propelled, amphibious vehicles, capable of navigating calm water, provided the following precautions are observed:

1. Do not enter water if the vehicle is overloaded. Refer to Specifications for recommended vehicle load capacity in water.
2. Do not use seat belts or any restraining device while the vehicle is floating in water. In shallow water, be prepared to free yourself from restraining devices quickly. If an emergency arises, you and your passengers may have to leave the vehicle quickly.
3. Do not attempt to cross large bodies of water. Stay close to the shore in case an emergency arises and you have to leave the water.
4. Do not attempt to navigate any body of water with a strong current. Avoid water operation under windy conditions.
5. Do not use the Argo in water when equipped with tracks unless it is also equipped with an outboard motor. The tracks will not propel the vehicle in water.
6. Use extra caution when operating the vehicle in cold water. If the vehicle upsets or swamps, exposure in cold water significantly reduces the chance of survival.
7. Be prepared to adjust the position of cargo and passengers so the vehicle floats level.
8. Care must be taken when encountering submerged obstacles that may damage or turn over the vehicle.

Observe the following safety precautions **BEFORE** entering the water:

1. All occupants must wear an approved personal flotation device (PFD) or life jacket while traveling in water.
2. Your vehicle is equipped with a bilge pump to empty water from the lower body. It is operated by a dash mounted rocker switch.
3. Even though your vehicle is equipped with a bilge pump, you should still carry a paddle and bailing can for water operation.

Getting To Know Your XTV

Water Entry

The point of entry should be free of rocks, stumps and other obstacles. Enter the water from a firm, gradual slope whenever possible. With the wheels partially submerged but still in contact with the bottom, stop and check thoroughly for water entering the lower body.

If a leak is detected, drive back onto shore. Drain the vehicle and repair the leak before re-entering the water.

If the body of water must be entered from uneven terrain, it may be better to back the vehicle into the water. With the engine and transmission weight concentrated in the front of the vehicle, the rear is lighter and floats higher if the rear compartment is not heavily loaded. In some cases, if there is a passenger or two and/or additional cargo in the rear, backing into the water could cause water to flood over the transom area and into the rear compartment. Always seek out a safer route for entry into the water if the terrain appears too dangerous.

Be careful not to submerge the bumper as you enter the water. With the bumper submerged, water can enter through the openings in the upper body.

Driving Procedures in Water

Enter the water from a firm gradual slope. If the water is deep enough for the vehicle to float, **(NOTE: If the vehicle is equipped with a ROPS, unlatch all seatbelts.)**

Use only part throttle when traveling through water. Full throttle only results in excessive turbulence, not higher speeds.

The vehicle is steered by a combination of pulling on the right bar and pushing on the left to steer right or vise-versa to travel left. The turning radius is somewhat greater in water, and the vehicle does not respond to changes in direction as quickly as it does on land. Turning in water may be more effective in Low gear.

The vehicle is propelled forward through the water by the web of the tires as they rotate. To back up in water, release the throttle, shift the transmission into neutral, and use a paddle.



CAUTION

Do not leave the vehicle in water for extended periods of time. Water could enter the axle seals and cause damage to the axle bearings.

We do not recommend the use of your Argo on frozen water surfaces because of the danger of breaking through the ice and the risk of exposure in cold water. If you must cross ice-covered bodies of water, take along an able-bodied person to assist if difficulties are encountered.

Driving Out of Water

When driving out of water, choose an area of the shore that is reasonably flat and free of rocks, stumps and other obstacles. Steer the vehicle so that both front wheels reach the shore at the same time. Accelerate slowly until the vehicle is out of the water. If vehicle is equipped with a ROPS system, re-fasten seatbelts.

Getting To Know Your XTV

Land Operation

If vehicle is equipped with a ROPS system, when operating the vehicle on land make sure all occupants, including yourself are wearing the seat belts and you are strapped in your seat firmly at all times. Loss of seating position could result in loss of control of the vehicle.

Be constantly aware of the overall height and width of your Argo vehicle equipped with the ROPS. Watch out for low objects, eg. brush, branches, etc. which could strike the ROPS and cause the vehicle to stop abruptly, rollover, or go out of control.

Due to the weight of the ROPS, your vehicle may be more likely to rollover on land than a standard Argo vehicle. Ensure passengers and operator remain seated at all times and keep all cargo low and evenly distributed.

Seat belts must be properly adjusted and worn by all occupants at all times EXCEPT when the vehicle is floating in water.

Winter Operation

Follow these precautions when operating the vehicle in winter conditions:

- Equip the vehicle for remote area use.
- Keep the battery fully charged and in good condition.
- Use the recommended winter grade of engine oil.
- Do not allow water or snow to accumulate in the vehicle. Snow may melt during operation of the vehicle, collect in the lower body and freeze around the chains and final drive components, immobilizing the vehicle.
- Store the vehicle indoors or under cover.
- Equip your vehicle with snow tracks for travel over deep snow.
- Snow-covered or icy inclines may be more difficult to ascend. Ice cleat kits are available for Super Track and Rubber Track systems. Contact your nearest dealer for details.
- Never travel alone into a remote area. Leave your route and arrival plans with someone who can send help if you fail to arrive as planned.

Use on Ice Covered Bodies of Water



WARNING

Using the vehicle on ice-covered bodies of water is potentially hazardous. Use extreme caution. Exposure to cold water reduces a person's chance of survival. Protective clothing, such as a marine survival suit will significantly decrease the effect of exposure in frigid water.

Before venturing out onto ice-covered bodies of water, it is extremely important to:

- Check the ice thickness and condition to be sure it will support the vehicle.
- Take all precautions referring to drain plugs.

If the vehicle breaks through the ice, it will float in the water, provided that there are no leaks in the body, the drain plugs are in place and vehicle is not taking on water through any body openings. However, there is a risk of the vehicle tipping, particularly if the load is unbalanced. Be prepared to shift occupants' weight for balance.

Getting To Know Your XTV

- Getting back onto safe ice depends on various conditions and the expertise of the driver. Be especially careful to prevent water from entering the vehicle.
- Balance the cargo and passenger load.
- Keep openings, like air intakes/exhaust, etc. above the water line.
- Keep the bilge pump running.
- Winch the vehicle out.
- Back onto ice, as the back end is lighter and floats higher in the water.
- Avoid getting the wheels on only one side onto the ice surface as water could enter over the opposite side of the vehicle.
- Avoid turning as the vehicle is climbing out to avoid possible roll-over.
- Break the thin ice around the vehicle with the paddle until there is firm ice for the vehicle to climb onto.
- Be wary of currents which may pull the vehicle under the ice.

If you feel that you may not be able to get the vehicle back onto safe ice or land, you might consider staying put to await rescue. This may be safer than trying to leave the vehicle to walk over thin ice.

Carrying Passengers And Cargo

1. Keep cargo as low as possible and evenly distributed.
2. Use extreme CAUTION when negotiating inclines with a loaded vehicle. Heavy loads and high loads decrease the stability of the vehicle and may cause it to roll. Be prepared to shift occupant weight and load forward or have passengers get out of the vehicle to climb an incline.
3. Secure cargo to prevent it from shifting while driving.
4. Do not mount any heavy fixtures to the upper body without support to the vehicle frame. The added weight may cause body deformation that could result in the tires rubbing through the body.



WARNING

Make sure all passengers riding in an ARGO equipped with tracks and ice cleats are informed to keep hands, feet and clothing inside the vehicle, well away from the tracks and ice cleats, while the ARGO is in motion. Serious injury or death could result from getting caught by the ice cleats.

Maximum Payload

Due to the additionally installed equipment, including any other ARGO accessories, the maximum available payload of the vehicle must be reduced accordingly; refer to specification section. Never exceed the maximum load capacity of the vehicle.

General

Ensure that an on-board fire extinguisher is fully charged at all times and have it inspected on a regular basis by qualified personnel.

We recommend that you do not venture out in your Argo without being accompanied by an able-bodied person to assist you in case you encounter difficulty. If this is not possible, make sure that adequate communications equipment (eg. cell phone, two-way radio) with an independent power supply is on-board and communication lines are open at all times to call for help if necessary. Remember, a simple technical failure could leave you stranded.

Getting To Know Your XTV

Trailer and Towing



WARNING

Never use the cargo racks as a towing or trailering point.

Your ARGO XTV is equipped with a frame-mounted receiver for a standard 2 inch (5.1 cm) receiver hitch. A standard receiver hitch must be purchased separately.

When loading a trailer properly, two items are critical. Gross Trailer Weight (the weight of the trailer PLUS the weight of the cargo) and Trailer Tongue Weight. See the Specification section.



WARNING

Ensure the load in the trailer is properly secured and will not shift while moving. Also, do not overload the trailer's capacity.



WARNING

NEVER EXCEED ANY OF THE XTVs LOAD CAPACITIES

Trailer Tongue Weight is the downward force exerted on the hitch by the trailer coupler when the trailer is fully loaded and the coupler is at its normal towing height. Refer to the Specifications section of this manual for tongue weight information.

Always maintain a slow speed when trailering and towing, and avoid sudden accelerations, quick maneuvers, and sudden stops. Braking distance will be affected when towing a trailer. When towing a trailer, always maintain slow speed and allow for more stopping distance than when not towing a trailer.



WARNING

Riding your XTV while towing a trailer requires extreme caution or the activity will be hazardous. Trailer towing will affect the handling and braking of your XTV. You should only tow at low speeds and never exceed 10 MPH. Avoid sudden accelerations and stopping. Do not make quick maneuvers. Avoid uneven surfaces and do not tow on hills. Never carry passengers in a trailer unless the trailer is designed for this purpose and has a rigid tow bar. Allow for more stopping distance when towing a trailer.

Transporting Your XTV

When transporting your XTV, ARGO recommends to set the XTV in its normal operating position (level, on all wheels) and use the following procedure:

1. Shift the XTV into the "F" (Forward) position and engage the parking brake.
2. Secure the XTV with hold-down straps rated to hold a load in excess of the weight of your XTV.

NOTE: Suitable hold-down straps are available from your ARGO XTV dealer. Ordinary rope is not recommended because it will stretch under load.



CAUTION

When attaching hold-down straps, care must be taken not to damage the XTV.

When transporting the XTV, make sure the parking brake is engaged, the transmission is in forward gear, and the XTV is properly secured.

Rear Seats

Removal

1. Grasp the inner edge of the rear seat at both ends.
2. Lift the inner edge of the rear seat upwards until both plastic bumpers are clear of the upper body.
3. Using an upward motion, pull the seat toward the center of the rear compartment.
4. Remove the seat.



Installation

1. Place the rear seat over the seat mounting holes in the upper body. Insert the large seat washers through the holes.
2. Using downward pressure, slide the seat towards the outside of the vehicle to lock it in place.

SECTION 6

Before You Ride

New Vehicle “Break-In” Procedure

To obtain long term, trouble free service from your vehicle, observe the following break-in guidelines:

1. Vary the speed of the vehicle for the first tank of fuel. Avoid full throttle operation during break-in period.
2. Check engine and transmission oil levels daily during break-in period.
3. Change the transmission oil after initial 20 hours of operation. Failure to do so can result in damage to the transmission bearings or gear surfaces. Refer to Section 8 for transmission oil changing instructions.
4. Change the engine oil after the first 20 hours of operation. Refer to Section 8 of this manual and the oil change section of each engine owner’s manual for oil change information.
5. Never overload your vehicle. Trying to steer an overloaded vehicle can overheat the brakes. This will lead to brake fade which means loss of steering control and the ability to stop the vehicle. Overloading the vehicle can lead to premature brake system failures and costly damage to drive chains, axles or bearings. Follow the recommended load capacity for the vehicle listed in Section 1.
6. Do not allow the brakes to drag, particularly during the first 10 hours of operation. To maximize brake pad life, start by making several low speed turns to both sides. Allow the brakes to cool by driving in a straight line. Repeat the low speed turns. Allow the brakes to cool again. This procedure will properly seat the brake pad friction material to the brake disc. The handlebar should be kept centered during straight ahead operation. Dragging the brakes will cause overheating of the brake components and result in poor brake performance.

Pre-Operation Checks

Carefully follow the engine manufacturer’s recommended pre-operation/daily checks as well as the following:

1. Check the fuel level.
2. Check the air pressure in all tires. NOTE: Improperly inflated tires can cause the vehicle to pull to one side, requiring constant steering correction. See Section 3 for tire pressure specifications.
3. Test the operation of the throttle lever by squeezing it to the fully open position and releasing it. The throttle must operate smoothly and return automatically to the fully closed position. Take the vehicle to an ARGO dealer if the throttle requires adjustment.
4. Check hand operated brake lever on left hand steering bar for braking capability. Check steering handle bar travel to the left and to the right for steering capability.
5. Check the engine intake and exhaust screen for obstructions. Clear any debris that has accumulated.

Operation - Before You Ride



WARNING

Failure to inspect or maintain the vehicle properly increase the possibility of an accident or equipment damage. Do not operate the vehicle if you find any problem. If a problem cannot be corrected by the procedures provided in this manual, have the vehicle inspected by the dealer.

Before operating this XTV, check the following points:

ITEM	ROUTINE
Fuel	<ul style="list-style-type: none">• Check fuel level in fuel tank and add recommended fuel if necessary.• Check fuel line for leakage. Correct if necessary.
Engine Oil	<ul style="list-style-type: none">• Check oil level in engine and add recommended oil to specified level if necessary.• Check XTV for oil leakage. Correct if necessary.
Transmission Oil	<ul style="list-style-type: none">• Check oil level in transmission and add recommended oil to specified level if necessary.• Check XTV for oil leakage. Correct if necessary.
Brakes	<ul style="list-style-type: none">• Check operation, if soft or spongy, have the dealer bleed the hydraulic system.• Check brake pads for wear and replace if necessary.• Check brake fluid level in reservoir and add recommended brake fluid to specified level if necessary.• Check hydraulic system for leakage. Correct if necessary.
Throttle Lever	<ul style="list-style-type: none">• Ensure smooth operation. Lubricate cable and lever housing if necessary.• Check lever free play and adjust if necessary.
Drive Select Lever	<ul style="list-style-type: none">• Ensure smooth operation. Lubricate lever pivoting point if necessary.
Wheels and Tires	<ul style="list-style-type: none">• Check wheel condition and replace if damaged.• Check tire condition and tread depth. Replace if necessary.• Check air pressure. Correct if necessary.
Brake Lever	<ul style="list-style-type: none">• Ensure smooth operation. Lubricate lever pivoting point if necessary.
Chassis Fasteners	<ul style="list-style-type: none">• Ensure all nuts, bolts and screws are properly secured.
Instruments, Lights and Switches	<ul style="list-style-type: none">• Check operation and correct if necessary.

Operation - Before You Ride

Hydraulic Brakes

1. Hand Brake Lever

Make sure there is no brake fluid leakage.

Check operation of the lever. It should move smoothly and there should be a firm feeling when the brake is applied. If not, have the XTV inspected by an authorized ARGO dealer.

2. Brake operation

Test the brakes at slow speed after starting out to make sure they are working properly. If the brakes do not provide proper braking performance, inspect the brakes for wear.



WARNING

POTENTIAL HAZARD

Riding with improperly operating brakes.

WHAT CAN HAPPEN

You could lose braking ability, which could lead to an accident.

HOW TO AVOID THE HAZARD

Always check the brakes at the start of every ride. Do not ride the XTV if you find any problem with the brakes. If a problem cannot be corrected by the adjustment procedures provided in this manual, have the XTV inspected by an authorized ARGO dealer.

Fueling the Vehicle



WARNING

Gasoline is extremely flammable and can explode under certain conditions. Do not add fuel while the engine is running or hot. If fuel is spilled in, on or around the vehicle, wipe it up immediately.

Use clean, fresh, unleaded gasoline in all models of the ARGO. Minimum 87 octane fuel is recommended.

Never use gasoline containing methanol or white gas since engine or fuel system damage could occur.

This model is equipped with a 8.5 gal (32.2 L) steel fuel tank located under the driver's seat. Verify your vehicle's actual fuel consumption before attempting any long trips. Never travel in remote areas or set out on long trips without a full tank of fuel and adequate spare fuel stored in approved watertight fuel containers.

The fuel filler neck and fuel cap are located on the right side of the vehicle behind the driver's seat. Replace the fuel cap if fuel leakage occurs, or if moisture is detected in the fuel.

Never fill the tank to the point where the fuel level rises into the filler neck. If the tank is overfilled, heat may cause the fuel to expand and overflow through the vent.

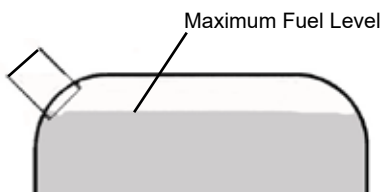

Operation - Before You Ride

Portable fuel containers may contain contaminants (dirt, water, etc.) that can cause engine operating problems. Use only clean, approved gasoline containers.

After filling the fuel tank, be sure the fuel cap is replaced securely. Do not drive the vehicle unless the fuel cap is properly in place.



CAUTION

Never use untreated gasoline that has been stored for more than 45 days. Stale gasoline can cause deposits to form in the fuel lines and carburetor. These deposits clog the fuel system and cause poor starting, no start condition or performance issues from the engine.

When storing the ARGO for 45 days or more, use ARGO Part No. 130-107 Fuel Stabilizer to treat fuel in the fuel tank and fuel containers.

Vented Fuel System - All Models

All ARGO models have fuel systems that are vented through a special hose connected to the top of the fuel tank. This vent hose runs along the upper body forward to the engine.



CAUTION

All Camouflage material is especially vulnerable to damage and peeling if it comes into contact with gasoline. Take precautionary action when refueling to protect the body from any such occurrences.

Fuel

Fill the fuel tank when necessary and make sure there is sufficient gasoline in the tank.

Check for leaks.

Fuel level should be below the filler neck.

Recommended Fuel

87 minimum octane rating

Tank **Capacity:** 8.5 gal (32.2 L)

Your ARGO engine has been designed to use regular unleaded gasoline with a pump octane number of 87 or higher. In many areas, oxygenates (either ethanol or MTBE) are added to the gasoline. Oxygenated gasolines containing up to 10% ethanol, 5% methane, or MTBE are acceptable fuel. If knocking or pinging occurs, use a different brand of gasoline or premium unleaded fuel. Unleaded fuel will give you longer spark plug life and reduced maintenance cost.

Use unleaded fuel only because it produces fewer engine and spark plug deposits and extends the life of the exhaust system. Never use stale or contaminated gasoline or an oil/gasoline mixture. Avoid getting dirt, dust or water in the fuel tank.

Operation - Before You Ride



WARNING

POTENTIAL HAZARD

Improper care when refueling.

WHAT CAN HAPPEN

Fuel can spill, which can cause a fire and severe injury.

HOW TO AVOID THE HAZARD

Do not overfill the fuel tank. Be careful not to spill fuel, especially on the engine or exhaust pipe. Wipe up any spilled fuel immediately. Be sure the fuel tank cap is closed securely. Do not refuel immediately after the engine has been running and is still very hot.

Engine Oil

Make sure the engine oil is at the specified level. Add oil as necessary. Check for any leaks.

Recommended engine oil

classification: API Service SJ type or higher. The recommended oil viscosity is SAE 5W-40. Ambient temperature should determine the correct weight of oil. See the viscosity chart or consult an authorized ARGO dealer for guidance.

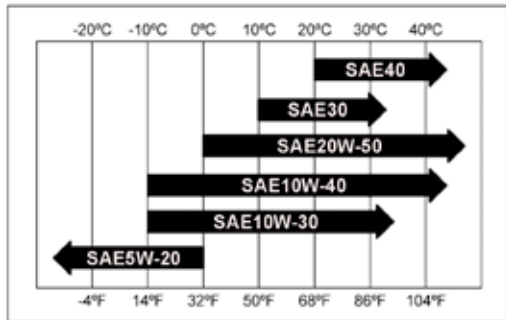

CAUTION

Be sure to use motor oils that do not contain anti-friction modifiers. Passenger car motor oils (often labeled “Energy Conserving”) contain anti-friction additives which will cause starter clutch slipping, resulting in reduced component life and poor engine performance.

Oil Level Inspection

NOTE: The XTV should be parked on level ground, with the engine key switch in the “OFF” position.

Your engine is equipped with a dipstick and a separate oil filler tube. Check the oil level, clean the area around the dipstick before removing. Remove the dipstick and wipe it with a clean cloth. Re-insert the dipstick and push it all the way into the tube. Remove the dipstick and check the oil level. The oil level should be between the ADD and FULL marks. If the level has dropped, add oil to bring the level up to the FULL mark. DO NOT OVERFILL.



CAUTION

Do not overfill the engine with oil. Overfilling the engine can cause oil leaks and/or oil contamination of the air filter element. Always make sure the oil level is above the “L” mark but not higher than the “F” mark.

Operation - Before You Ride

To add engine oil:

Refill the engine through the oil fill port. Make sure the appropriate grade of oil is used. As you add oil, frequently check the level with the dipstick. Do not overfill. Start engine. Check for leaks. Stop the engine. Check the oil level. Add oil only to the "Full" mark on the dipstick.

Transmission Oil Inspection



CAUTION

Any lubricant used in place of the recommended lubricant may cause serious damage.

NOTE: The XTV should be parked on level ground, with the engine key switch in the "OFF" position.

Check for correct oil level by viewing the sight glass installed to the lower portion of the transmission housing. To view this sight glass, remove the kick panel. Oil filling half the sight glass indicates correct oil level.

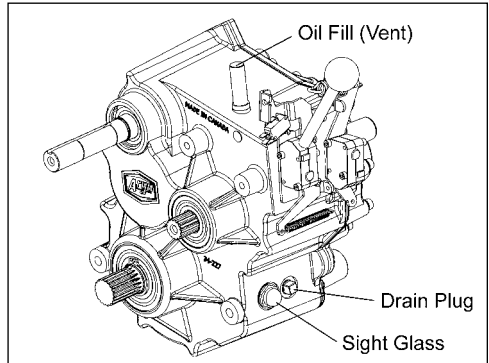

CAUTION

Ensure no foreign material enters the gear case.

To add transmission oil:

Remove the fill/vent plug located on the top of the transmission. Fill the transmission with 80W90 Gear Lube or ARGO brand 75W90 Synthetic lube (Part No. 130-104). Fill the transmission until the sight glass is half full. For Oil capacity see Oil Capacity Chart.

Operation - Before You Ride

Throttle Lever

Check to see that the throttle lever operates correctly. Throttle must open smoothly and spring back to the idle position when released. Adjust as necessary for proper operation.

Fittings and Fasteners

Always check chassis fittings and fasteners to ensure they are tight and secure. Take the XTV to an authorized ARGO dealer or refer to the Service Manual for correct torque specifications.

Lights

Check the headlight, taillight and brakelight to ensure they are in proper operating condition. Repair as necessary for proper operation.

Switches

Check the operation of the headlight switch, emergency stop switch and any other switches. Repair as necessary for proper operation.

Tires

1. The tires listed below have been approved by ARGO for this model. Other tire combinations are not recommended.

How to Measure Tire Pressure

Use a low-pressure tire gauge.

NOTE: Make two measurements of the tire pressure and use the second reading. Dust or dirt in the gauge could cause the first reading to be incorrect.



WARNING

POTENTIAL HAZARD

Operating this XTV with improper tires, or with improper or uneven tire pressure.

WHAT CAN HAPPEN

Use of improper tires on this XTV, or operation of this XTV with improper or uneven tire pressure, may cause loss of control, increasing the risk of an accident.

HOW TO AVOID THE HAZARD

Follow the recommended tire pressures in the Operator's Manual.

Set tire pressure to the following (tires cold):

Recommended Tire Pressure:
2.5 - 3.5 psi (17 - 24 kPa)



1. Low-pressure tire gauge

Operation - Before You Ride

Tire Wear Limit

When the tire groove decreases to 0.16 in (4 mm) due to wear, replace the tire.

A. 0.16 in (4 mm)

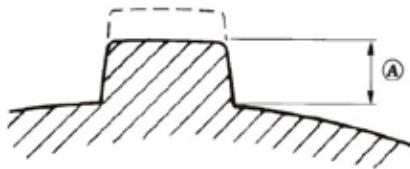

WARNING

POTENTIAL HAZARD

Operating this XTV without being familiar with all controls and functions.

WHAT CAN HAPPEN

Loss of control, increasing the risk of an accident or injury.

HOW TO AVOID THE HAZARD

Read the Operator's Manual carefully. If there is a control or function you do not understand, contact an authorized ARGO dealer.

SECTION 7

Operation

Always wear the following to reduce risk of injury in an accident:

- Approved helmet that fits properly.
- Eye protection (goggles, helmet face shield or protective eyewear)
- Over the ankle boots, gloves, long sleeved shirt or jacket and long pants.

An approved helmet and other personal protective equipment can reduce the severity of injuries in an accident.



WARNING

Operating without an approved helmet increases your chances of a severe head injury or death in the event of an accident.

Wear eye protection when operating your XTV to reduce the risk of a serious accident or injury. Eye protection such as a face shield or goggles may reduce the risk of foreign material getting in your eyes and help prevent loss of vision.



WARNING

Operating without eye protection can result in an accident and increases your chances of a severe injury in the event of an accident.

Entering the XTV

1. Position yourself in the seat.
2. Always keep your hands on the handlebars and back firmly placed against the seat back.

Starting the XTV



WARNING

Never start or run the engine in a closed building or confined area. Engine exhaust gases contain poisonous carbon monoxide. Carbon monoxide is odorless, colorless and can cause serious personal injury or death.

The vehicle is equipped with a key operated, electric start system with the start button located on the left side steering bar. To start the vehicle, proceed as follows:

1. Operator positioned in the driver's seat.
2. Apply hand brake.
3. Apply the parking brake.
4. Place the transmission in the neutral (N) position.
5. Release the hand brake.
6. Move the emergency stop switch to the RUN position.

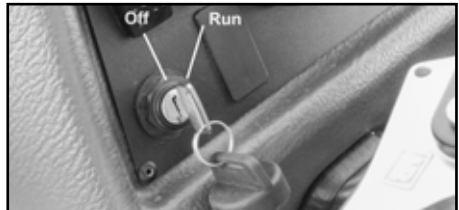

Operation

- Turn the ignition key to the "ON" position.
- Place hands on handlebar grip areas.
- Apply hand brake.
- Move throttle lever so throttle plate is approximately 1/8th open and hold.
- Press the start button.



CAUTION

Do not operate the starter continuously for more than 5 seconds or the starter may overheat. Wait 30 seconds between each operation of the starter to let it cool and the battery power to recover. Never attempt to restart the engine until the engine completely stops. Always remove key from switch when leaving vehicle unattended or when vehicle is not in use.

- Release start button once engine starts.
- Allow engine to warm up.

Priming Procedure

Your vehicle is equipped with an electric high pressure fuel pump located inside the fuel tank.

If the vehicle has run out of fuel, follow the procedure below to prime the fuel system to restart.

- Turn the key switch to the "RUN" position for one minute. Allow the fuel pump to cycle and prime the system. Turn the key switch "OFF".
- Perform the STARTING PROCEDURE to crank and start engine.
- If the engine fails to start, repeat steps 1 and 2. If the engine does not start after two priming intervals, contact your ARGO Service Dealer for further assistance.

Operation

Stopping The Engine

Release the throttle lever. Let the engine speed return to idle.

Turn ignition key switch to the "OFF" position. Always remove key from ignition switch when leaving the vehicle unattended.



Selecting And Changing Transmission Gears



CAUTION

DO NOT CHANGE TRANSMISSION GEARS WHILE THE VEHICLE IS MOVING.
To change gears, bring the vehicle to a complete stop, let the engine idle down completely, engage hand brake and move the shift lever to the selected gear.

Changing Transmission Gears

The "Admiral" transmission is equipped with two shift levers. The Forward/Neutral/Reverse shift lever is located through the lower kick panel and moves side to side. Forward gear is located to the left of neutral and reverse gear to the right of neutral. PLEASE OBSERVE CAUTIONS.

The High/Low range shift lever is located in the upper dash. High range is selected when the lever is in the up position and should be used for most driving conditions. Low range is selected when the lever is in the down position.



CAUTION

Do not attempt to move the gear shift from the neutral (N) starting position until the engine idles down completely. If the engine idle speed is too high, the transmission will grind during gear engagement.



Operation

Driving Straight Ahead

The handlebar is spring loaded to return to a centered position. At this location, no braking is applied to either of the steering calipers. It is at this position that the handlebar should be when driving straight ahead. Apply the throttle slowly until the clutch system engages and the vehicle moves forward.



CAUTION

Avoid inadvertently riding the hand brake while steering and driving the vehicle. Riding the hand brake will overheat the brake system.

Stopping The Vehicle

Release the throttle lever, then squeeze the hand brake lever.

Turning The Vehicle

The ARGO is a skid steer vehicle. The rear of the vehicle swings outward during a turn. Always take precautions when making turns to avoid contacting foreign objects.



WARNING

Sharp turns, especially at high speeds or when heavily loaded, may cause the vehicle to roll over. Slow the vehicle down before making a turn. Do not apply the brakes too suddenly.



CAUTION

Do NOT over-steer. Avoid the tendency to push or pull harder on the steering system if the vehicle is not responding as expected. Once the vehicle's brake disc has been locked, pushing or pulling harder on the steering system will not increase the turning capacity of the vehicle. Damage may occur to the steering system as a result of over-steering.

Operation

Left Turn

To make a left turn, pull back on the left handlebar while at the same time pushing on the right to slow or stop the wheels on the left side of the vehicle. When the turn has been completed, return the handlebar to the center position.

Right Turn

Pull back on the right handlebar while at the same time pushing on the left to slow down or stop the wheels on the right side of the vehicle. When the turn has been completed, return the handlebar to the center position.

Driving the Vehicle in Reverse

With the engine at idle, shift the transmission into reverse. Ensure that the handlebar is centered. Squeeze the throttle lever slowly until the clutch engages and the vehicle moves backwards. Increase speed by slowly squeezing the throttle. It is recommended that the Hi/Low shift be set in the Low position when operating in reverse.

Turning The Vehicle While in Reverse

Pull on the right bar and push on the left to turn right. Pull on the left bar and push on the right to turn left. When turning the vehicle while backing up, the rear of the vehicle swings in the direction of the turn. This is unusual for most people who are not familiar with skid steer vehicles. Carefully practice backing up and turning in an open area until you become accustomed to this procedure. Take precautions to avoid hitting persons or objects.

Gear Selection

The ADMIRAL is a triple differential transmission. The ADMIRAL features two distinct modes of operation, HIGH range for typical trail riding and LOW range when tight turns are required.

When operating in HIGH range, a full lock right steering input will cause the right side wheels to turn forward at a lower rate (approximately 1/3 the speed) compared to the left side wheels and vice versa when full lock left steering input is applied.

When operating in LOW range, a full lock right steering input will cause the right side wheels to slow down and come close to a complete stop. This will result in a much tighter turn. This mode of operation should only be used for slow speed operation when tight turning is required.



CAUTION

Extended use of Low range at higher speeds may result in increased engine, transmission and brake temperatures. This mode of operation should be avoided unless the terrain or obstacles warrants its use.

Operation

Selecting Forward, Neutral, Reverse, High or Low

The ADMIRAL transmission uses dog clutches to engage internal gears. The dog clutch is not synchronized to allow for shifting while the vehicle is in motion. To avoid personal injury, transmission, vehicle or property damage, always bring the vehicle to a complete stop, allow the engine to return to idle, compress and hold the hand brake, then select the appropriate gear function. Once selected, release the hand brake and accelerate to desired speed.

NOTE:

When selecting from HI to LOW or LOW to HI, the dog clutch may not automatically engage its mating gear. This is normal and expected. The HI and LOW selector is spring-loaded and will lock into place once engine RPM rises and clutches begin to engage. A slight, but normal, “clunk” sound may be heard during this procedure.

Recommended Gear Selections

Trails and higher speed driving: Recommended gear selection HIGH range: The increased efficiency results in cooler running temperatures for the engine, transmission and steering system.

Towing: Recommended gear selection LOW range: With increased efficiency and positive all-wheel drive in high range, the operator is able to maintain momentum, traction and control while under load. Engine power and smooth steering is maintained, point-turn operation is eliminated, allowing for smooth operation and towing.

Traversing Inclines: Recommended gear selection is HIGH range: climbing hills successfully means maintaining traction and momentum. It is usually unwise (and unsafe) to perform sharp turns while climbing hills, so Low range, if required, should be used with caution in these situations.

Mud and Snow (including track use): Recommended gear selection HIGH or LOW range: Low traction situations are usually handled best in high range due to the fact that any turning inputs will “lock the differential” and force all wheels to drive. If tightly spaced obstacles are present, low range will provide added maneuverability, albeit at a cost in both traction and efficiency.

Water / Amphibious use: Recommended gear selection HIGH or LOW range: While operating the vehicle in deep water, either range selection may be appropriate. In High range, the operator may notice a lack of maneuverability, especially at full throttle. In Low range, the inside, or steered, tires can counter rotate thereby providing greater maneuverability and control when turning the vehicle. There is a slight reduction of top speed when selecting Low range for water / amphibious use.

Low speed (with obstacles): Recommended gear selection Low range: While traversing a rock field or a wooded area, increased maneuverability available in Low range is a valuable asset. Switching back to High is highly recommended when the terrain clears and tight / sharp turning is not required.

SECTION 8

Oil, Filter And Lubrication Information



WARNING

Detailed information on standard workshop and safety procedures and general installation practices is not included here. ARGO assumes no responsibility or liability for PERSONAL INJURY or VEHICLE DAMAGE which results from any procedure performed, including those procedures outlined here. Before performing any procedure, an individual must have determined to his/her satisfaction that personal injury or vehicle damage will not result from the procedure, working environment or tools selected.

Checking the Engine Oil Level

Check the engine oil level each day before operating the engine.

To check the oil during an operating period, shut the engine off, let it cool down and allow the oil time to drain into the sump before checking the oil level. Position the vehicle so the engine is level.

Your engine is equipped with a dipstick and a separate oil filler tube. Check the oil level, clean the area around the dipstick before removing. Remove the dipstick and wipe it with a clean cloth. Re-insert the dipstick and push it all the way into the tube. Remove the dipstick and check the oil level. The oil level should be between the ADD and FULL marks. If the level has dropped, add oil to bring the level up to the FULL mark. DO NOT OVERFILL.

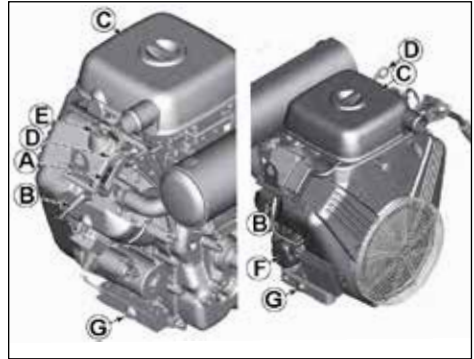

- | | |
|-----------------|----------------|
| A - Engine ID | E - Oil Fill |
| B - Spark Plug | F - Oil Filter |
| C - Air Cleaner | G - Oil Drain |
| D - Dipstick | |



CAUTION

Do not run the engine if the oil level is above the FULL mark or below the ADD mark. Premature engine damage or total engine failure can occur when the oil level is not properly maintained.

Recommended Engine Oil

Use a high quality detergent oil of API (American Petroleum Institute) service class as listed in chart. Choose the correct viscosity of oil for seasonal driving conditions. Using the proper type and weight of oil in the crankcase is extremely important. Recommended engine oil Engine oil for 4-stroke engine: API classification: SE, SF or equivalent to SG, SAE 5W-40 synthetic.

Oil, Filter And Lubrication Information

Check oil daily and change oil regularly. Failure to use the correct oil, or using dirty oil, causes premature engine wear and failure.

Engine Oil Capacity:

With Filter: 2.3 L (2.4 qts.)

Changing Engine Oil

During the initial engine break-in period, change the oil after the first 20 hours of operation. After the break-in period, change the engine oil every 100 operating hours or annually or more frequently if the vehicle is operated in dusty or dirty conditions.

Draining the Engine Oil

Each engine is equipped with a drain plug for draining the oil. Drain the oil from the engine as follows:

1. Start and warm up the engine so the oil will drain easily.
2. Level the vehicle so the oil will drain completely.
3. Place a suitable container under oil drain of engine and remove drain plug.

There is limited space between the engine and power pack frame. Cut down an empty plastic container to the correct height so it will fit under the engine oil drain. Make sure the container will hold the correct amount of oil in the engine.

As an alternative to draining the engine oil from the drain plug you can use a vacuum pump and remove the oil through the dipstick tube. A pump suitable for this is available through your ARGO dealer, Part No. 638-02.

Please Dispose Of Waste Oil Properly To Conserve Our Environment.

4. When all the oil has been drained from the engine, clean and replace the drain plug. Torque drain plug to 22 - 25 ft lb (30 - 35 N-m).

Oil Filter

Change the oil filter when the oil is changed

Before installing the new filter, lubricate the rubber filter gasket with clean engine oil. Screw the filter on by hand until the gasket contacts filter adapter. Tighten 1/2 to 3/4 turn more. Start and run engine to check for oil leaks. Stop engine and re-check oil level. Add oil if required.

Oil, Filter And Lubrication Information

Refilling the Engine

Refill the engine through the oil fill port. Make sure the appropriate grade of oil is used. As you add oil, frequently check the level with the dipstick. Do not overfill. Start engine. Check for leaks. Stop the engine. Check the oil level. Add oil only to the "Full" mark on the dipstick.

Transmission Oil Information

Checking the Transmission Oil Level

Check for correct oil level by viewing the sight glass installed to the lower portion of the transmission housing. To view this site glass, remove the kick panel. Oil filling half the site glass indicates correct oil level.

Changing the Transmission Oil

Removing the oil from the Admiral transmission requires the use of a vacuum style pump such as the 638-02 available from ARGO.

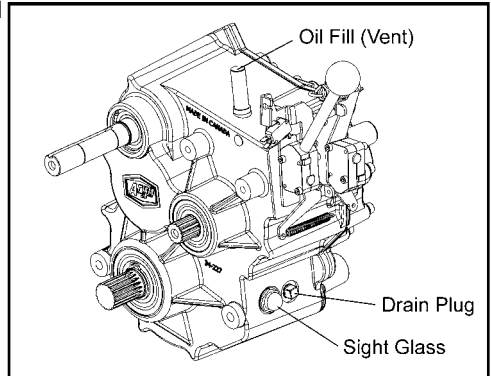

Due to the design of the ADMIRAL transmission, the majority of the oil in the case will be below the drain plug.

Remove the drain plug and drain the oil until the flow stops. Insert the vacuum tube into the drain plug hole and remove the remaining oil from the transmission sump.

Refilling the Transmission

Install the drain plug. Remove the fill/vent plug located on the top of the transmission. Fill the transmission with 80W90 Gear Lube or ARGO brand 75W90 Synthetic lube (Part No. 130-104). Fill the transmission until the sight glass is half full. For Oil capacity see Oil Capacity Chart.

Transmission Oil Capacity	
Admiral (34-200)	1.2 L

Oil, Filter And Lubrication Information

Filter information

Air Filter

Your engine is equipped with a foam precleaner and dry paper air filter element housed in an air cleaner assembly attached to the throttle body/ carburetor.

Replace or wash precleaner in warm water with detergent. Rinse and allow to air dry. Saturate precleaner with new engine oil; squeeze out excess oil. Replace the paper element.

Wash and oil the precleaner after every 25 hours of operation or more often under extremely dusty or dirty conditions.



Check the paper air filter element every 100 hours of operation or more often under extremely dusty or dirty conditions.

Fuel Filter

Your fuel system utilizes a fuel filter sock attached to the pickup tube within the fuel tank. This eliminates the need for an inline fuel filter. No external inline fuel filter maintenance is required.

Lubrication Information

General

The following parts and components require regularly scheduled lubrication to prevent premature wear and replacement.

1. Drive Chains
2. Bearings

Use the recommended lubricants listed in this section and carefully observe the recommended lubrication intervals.

Drive and Driven Clutch

No lubrication is required for either the driven clutch or driver clutch. They are designed to run dry. If lubricant is used, use of the vehicle will attract dirt and cause damage to the clutch components. Contamination by dust and dirt can cause poor performance, premature wear or failure. Use compressed air to remove any belt dust that may accumulate on the clutches.



WARNING

Only qualified personnel should perform installation, maintenance, adjustments and repair operations on the variable speed transmission system.

A complete service of the clutch units is required after every 250 hours of operation. To perform this procedure, the clutches must be disassembled. Special tools are required to disassemble the clutch units. We recommend that you return your vehicle to an authorized ARGO dealer to have the clutch units serviced.

Oil, Filter And Lubrication Information

Drive Chain Lubrication

Lubricate the chains every 10 hours with Aerosol Chain Lube (ARGO Part No. 130-101), or more frequently in dirty or wet conditions.



CAUTION

Monitor steering brake discs and service brake discs weekly, for any signs of oil contaminated dirt and debris. This can be the result of excess oil spraying from moving chains. Regularly clean or pressure wash drive train if oily dirt and debris builds up on drive chains, brake discs or other components that could affect vehicle performance and braking capabilities.

Outer Axle Bearing Lubrication



CAUTION

Do not use high pressure Pneumatic greasing equipment or excessive amounts of grease. Damage to the bearing seals could result.

Each outer axle flange is equipped with one grease nipple. This grease nipple supplies grease directly to the outer axle bearing. It requires re-greasing every 25 hours of operation or before the vehicle is taken out of service for any extended period. Use a pistol grip type grease gun to avoid dislocating the bearing seals due to excessive grease pressure.

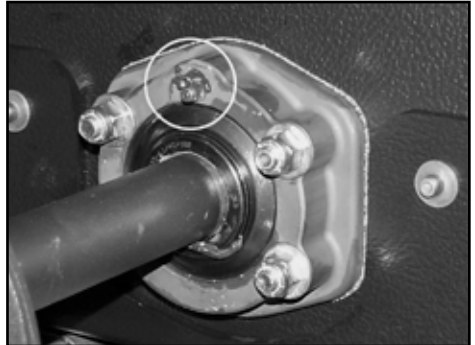

To promote regular maintenance of important ARGO components, ARGO has provided an access hole through each rim and hub for ease of bearing lubrication.

Oil, Filter And Lubrication Information

Idler Shaft Outer Bearing Lubrication (Easy Access Grease Zerks)

Easy access grease zerks are located on the lower front frame below the F-N-H shift lever. These zerks supply grease to the front inner axle bearings and the left and right hand side outer idler shaft bearings. The easy access grease zerks are accessible with the kick panel removed.

Grease with a small amount of a lithium based, NLGI #2 or 3 mineral oil based grease, (ARGO Brand Multi-Purpose Grease Part No. 130-105). Apply every 50 hours of operation, if vehicle has

been used in water for extended periods of time or whenever major maintenance is performed on the vehicle.

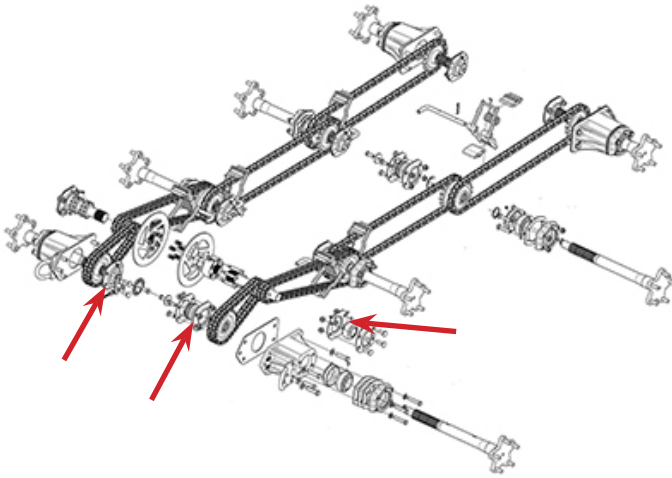
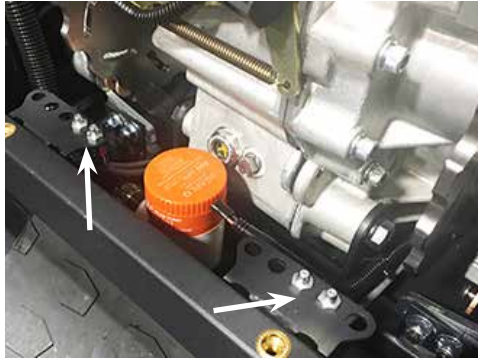

Inner Axle Bearing Lubrication

The inner axle flanges are equipped with a grease nipple. Lubricate the bearings with a small amount of a lithium based, NLGI #2 or 3 mineral oil based grease, (ARGO Brand Multi-Purpose Grease Part No. 130-105). Apply every 50 hours or before the vehicle is taken out of service for any extended period. Dirt, dust and exposure to water will accelerate this servicing to less than 50 hour intervals. Only a small amount of grease is required.

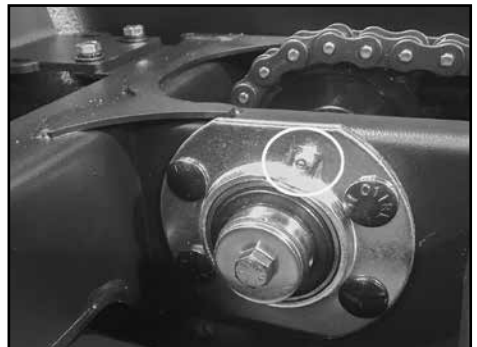

Oil, Filter And Lubrication Information

Output Shaft Coupler Lubrication

Output shaft spline couplers are equipped with a grease fitting to allow lubrication to the spline of the shaft and coupling connector. Lubricate every 25 hours with a lithium based, NLGI #2 or 3 mineral oil based grease, (ARGO Brand Multi-Purpose Grease Part No. 130-105). Wipe off any excess grease.

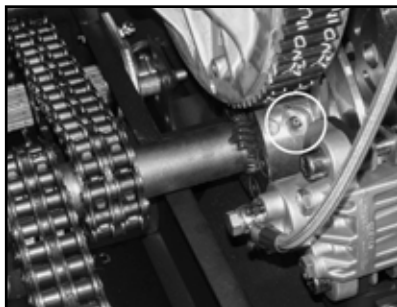

Momentary Chain Oiler System



CAUTION

Proper lubrication of the chain drive components greatly increases their service life. Keeping chains out of water and dirt will also improve the effectiveness of chain lubrication.

Operation:

The automatic chain oil system operates with a manually controlled rocker type switch on the dash and will run the pump for as long as the switch is pressed.

Recommended Oil:

ARGO Brand Chain Lube Auto Oil - 1L (part no. 130-100) or any good quality oil of the proper viscosity (based on temperature, see chart) can be used. The oil must be able to penetrate into the bushings and side plates to be effective.

Do not use used oils, high tack oils (i.e. chainsaw bar oil), heavy oil, or grease

If the Argo needs to be used in environmentally sensitive areas, consider using a biodegradable oil of the proper viscosity as shown in the chart.

TEMPERATURE	-40 ~ 0 C (-40 ~ 32 deg. F)	0 ~ 40 C (32 ~ 104 deg. F)	40 ~ 50 C (104 ~ 122 deg. F)
OIL VISCOSITY	SAE 10 or 5W-30	SAE 20 or 10W-30	SAE 30 or 10W-40

Oil, Filter And Lubrication Information

First time operation:

- Fill the reservoir with appropriate oil.
- Remove the front floor pan, firewall, and rear floor pan.
- Turn the key to run position, press and hold switch. You will hear the pump.
- With the pump running watch below the drip tubes to see when the oil begins to drip. It may take close to 2 minutes of continuously holding the switch before the system is primed. The oil will start dripping on the front chains several seconds before it drips on the rear.
- Once the oil starts dripping watch the drips to make sure they are falling onto the side plates of the chain.
- Loosen the bolt holding the drip tube and adjust the position as required.
- Periodically check to make sure all holes are dripping oil correctly.
- Wiping the bottom of the drip tubes with a rag will remove any larger deposits of dirt.
- A full reservoir of oil should last approx 40 hrs of run time.



System may require priming if reservoir is run dry or after extended periods of non use.

Maintenance:

- Check the level in the reservoir prior to daily operation.
- For optimum pump and chain life, do not let the reservoir **Momentary Chain Oiler System** run dry.

SECTION 9

Maintenance Information

MAINTENANCE SCHEDULE									
	Before each use	AFTER INITIAL (HOURS)			EVERY (HOURS)				
		2	8	20	10	25	50	100	250
Check fuel level	X								
Check tire inflation	X								
Check throttle lever operation	X								
Check handlebar travel	X								
Check engine intake/exhaust for obstruction	X								
Ensure drain plugs are in place	X								
Check engine oil level	X								
Change engine oil and filter				X				X	
Check transmission oil level	X	X							
Change transmission oil				X				X	
Check/clean/replace air filter								X	
Service drive and driven clutch									X
Lubricate drive chains					X				
Remove/clean and lube drive chains									X
Lubricate outer axle bearings						X			
Lubricate inner axle bearings							X		
Lubricate output shafts							X		
Lubricate idler shaft bearings							X		
Clean battery and terminal connections								X	
Clean/adjust/replace spark plugs								X	
Check drive belt						X			
Check nylon sliders - driven clutch								X	
Check slider blocks - Chain take-up system					X				
Inspect brake pads						X			
Inspect/adjust parking brake						X			
Check hydraulic brake fluid level							X		
Check fuel tank connection lines								X	
Inspect wiring harness								X	
Tighten bearing extension/axle flange bolts					X			X	
Clean spark arrestor								X	

The intervals shown on the schedule are based on average operating conditions. Vehicles which are subjected to severe use and wet or dusty conditions will require more frequent servicing. Use only Argo replacement parts to ensure safe operation of the vehicle and to comply with the warranty coverage.

We strongly recommend that an Argo Dealer perform a complete check-over of your vehicle after the initial 20 hours of operation, then once each year. This will reduce maintenance costs over the life of your vehicle.

Maintenance Information

20/20 SERVICE CHART 20-POINT INSPECTION AFTER 20 HOURS OF OPERATION

- | | |
|--|---|
| <ul style="list-style-type: none">√ Change engine oil and filter√ Inspect air filter√ Change transmission oil√ Inspect and adjust chain tensioners√ Inspect steering and stopping brake operation√ Check tightness of all bearing and sprocket set screws√ Grease inner, outer & output shaft bearings√ Lubricate drive chains√ Inspect and clean air intake√ Inspect electrical system√ Inspect lower body and skid plate√ Adjust and set tire pressures | <ul style="list-style-type: none">√ Clean battery posts/check charging system operation√ Check engine idle speed & top no load RPM, adjust as required√ Adjust parking brake cable√ Inspect fuel system and filter√ Inspect ITC & belt. Adjust secondary clutch as required√ Re-torque axle bearing and extension bolts√ Adjust steering plunger pins if required√ Operational check of all Argo Accessories |
|--|---|

100/12 SERVICE CHART 100 HOURS OR ONCE A YEAR SERVICE

- | | |
|--|---|
| <ul style="list-style-type: none">√ Change engine oil and filter√ Inspect air filter√ Change transmission oil√ Inspect and adjust chain tensioners√ Inspect steering and stopping brake operation√ Check tightness of all bearing and sprocket set screws√ Grease inner, outer & output shaft bearings√ Lubricate drive chains√ Inspect and clean air intake√ Inspect electrical system√ Inspect lower body and skid plate√ Adjust and set tire pressures | <ul style="list-style-type: none">√ Clean battery posts/check charging system operation√ Check engine idle speed & top no load RPM, adjust as required√ Adjust parking brake cable√ Inspect fuel system and filter√ Inspect ICT & belt. Adjust secondary clutch as required√ Re-torque axle bearing and extension bolts√ Adjust steering plunger pins if required√ Operational check of all Argo Accessories |
|--|---|

Maintenance Information

NOTE:

An annual complete check over of your ARGO vehicle is recommended. This will reduce maintenance costs over the life of your vehicle and ensure it will function properly during use periods.

Daily Checklist - Minimum Recommendation

Inspect The Following

◆ Check/Clean Exhaust Screen
◆ Check/Clean Hood Screen
◆ Check/Hi-Lo Shifter (Cable Inspection)
◆ Check Forward/Reverse Shifter (Cable Inspection)
◆ Check Parking Brake (Cable Inspection)
◆ Check Handbrake (Fluid Level)
◆ Check Coolant Level (Liquid Cooled Models Only)
◆ Check Fuel Level
◆ Check Tire Inflation
◆ Check Oils (Engine & Transmission)
◆ Check Throttle Cable Operation
◆ Check Lower Body For Damage Or Punctures
◆ Check Electrical, Lights, Wiring, Horn (if equipped)
◆ Check Drain Plug Installation
◆ Check/Clean Air Intake Screen

Check and inspect all accessories for proper fit and performance.

Maintenance Information

Maintenance Procedures

Maintenance procedures described in this manual are the responsibility of the operator. These procedures include:

- checking fluid levels
- changing the engine and transmission oil
- checking and replacing filters
- preventable maintenance
- inspections, adjustments, repairs and troubleshooting

If you perform your own maintenance, carefully follow the lubrication and preventable maintenance schedule.

If the operator is not comfortable performing maintenance, an Argo dealer can perform regular maintenance and lubrication at the owner's expense.

The troubleshooting chart contains information for locating and correcting mechanical concerns. In many cases, potential concerns can be identified by unusual sounds, sluggishness or vibrations before they result in a breakdown. Refer to the chart to identify these symptoms. Take immediate corrective action or take the vehicle to an authorized Argo dealer for service.

Electrical System



WARNING

Detailed information on standard workshop and safety procedures and general installation practices is not included here. ARGO assumes no responsibility or liability for PERSONAL INJURY or VEHICLE DAMAGE which results from any procedure performed, including those procedures outlined here. Before performing any procedure, an individual must have determined to his/her satisfaction that personal injury or vehicle damage will not result from the procedure, working environment or tools selected.

AGM Battery



WARNING

Battery fluid contains sulphuric acid. If battery fluid comes in contact with skin or eyes, flush thoroughly with water. If swallowed, call physician or poison control centre immediately. KEEP AWAY FROM CHILDREN. Serious personal injury can occur. Always wear rubber gloves and safety glasses when servicing the battery.

Batteries can explode and cause serious personal injury if exposed to flame or sparks.

The battery is located under the hood on the passenger side of the vehicle.

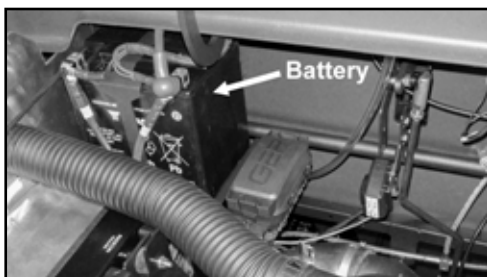

Maintenance Information

Activating and Charging AGM Batteries

Un-activated AGM batteries can be stored for long periods of time as long as they are kept in a cool, dry location and out of direct sunlight. Also the foil sealing strip covering the filler ports should not be removed until the battery is ready to be activated. Use only the electrolyte container that comes with the battery for filling the cells as it has a higher concentration of sulphuric acid than the acid used for conventional batteries.



The electrolyte container that is shipped with a dry AGM battery contains the correct amount of battery acid and is more concentrated than the electrolyte used in a conventional battery. All AGM battery electrolyte containers are not the same. Each contains the proper amount of electrolyte for its specific battery.

Before filling, read the electrolyte handling instructions and precautions on the label. Always wear protective gloves and protective eyewear and be sure to read the Battery Safety section that comes with your battery. The following seven steps should be used to activate an AGM battery:

1. The battery must be out of the vehicle and placed on a level surface.
2. Remove electrolyte container from the plastic storage bag. Remove the strip of caps. **Put the strip aside as you will use it later to seal the battery cells.** For battery filling use only the dedicated acid container that comes with the battery as it contains the proper amount of electrolyte for that specific battery. This is important to service life and battery performance. Do not pierce, or otherwise open the foil seals on the electrolyte container. Do not attempt to separate the individual electrolyte containers.
3. Place the electrolyte container with the foil seals facing down into the cell filler ports on the battery. Hold the container level and push down to break the foil seals. Electrolyte will start to flow into the battery and air bubbles will be seen inside the container. Do not tilt the electrolyte container.

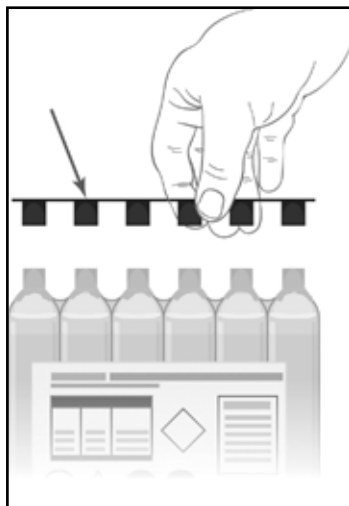

Maintenance Information

4. Check the electrolyte flow. Keep the container in place for 20 minutes or longer until it empties completely. If no air bubbles are coming up from the filler ports, or if container cells haven't emptied completely after 20 minutes, tap the container and/or battery case a few times to cause the electrolyte to flow into the battery. Do not remove the acid container from the battery until it is completely empty. The battery requires all of the electrolyte from the container for proper operation.

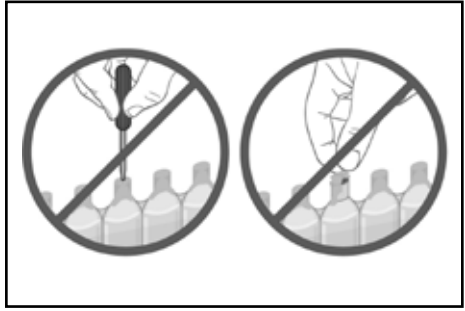

Bubbles will appear as the electrolyte container fills the battery indicating the flow of battery acid. Tap the container periodically to keep the electrolyte flowing until the container is completely empty. Never puncture the top of the acid container to speed up the filling process.

5. Remove the empty electrolyte container from the battery. Fully insert the strip of sealing caps (previously removed from the electrolyte container) into the battery filling ports. Make sure the strip of caps is fully inserted and flush with the top of the battery. Insert the caps by hand, do not use a hammer or excessive force. Never remove the strip of caps or add water or electrolyte to the battery during its service life.



After filling, the sealing caps should be installed using hand pressure only. The sealing cap should never be removed once the battery is activated.

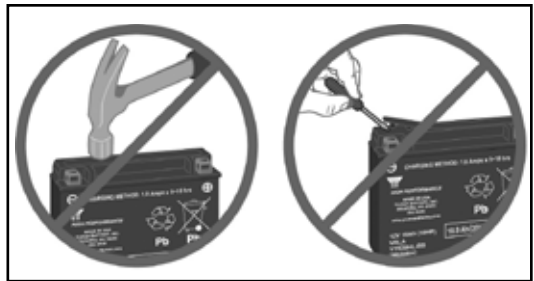

6. Allow the battery to sit for 2 hours to allow acid to properly soak into the glass mats inside the battery.

NOTE: If the soaking period is not adhered to, the battery may present poor performance output.

Maintenance Information

7. Newly activated AGM batteries require an initial charge. After adding electrolyte, a new battery is approximately 75-80% charged. After the “stand” period (step 6), charge the battery to bring it to a full state-of-charge. The battery charger used for initial charging should be able to charge at 12 volts at 1.5-2 amps for an AGM battery. All Yuasa battery chargers are capable of reaching this minimum voltage and initializing/activating an AGM battery.



WARNING

Ventilate area when charging. Keep away from spark or open flame.

Cleaning the Battery Terminals and Cable Connections

Clean the battery terminals and cable connections every 100 hours. Remove the black NEGATIVE (-) cables first. Make sure you reconnect the NEGATIVE (-) cables to the NEGATIVE (-) post and the red POSITIVE (+) cables to the POSITIVE (+) posts. Damage to the electrical system will occur if the cables are reversed.

Cleaning the Battery

Clean the top of the battery every 250 hours with a mixture of baking soda and water. Soak a cloth in the soda/water mixture and scrub the top of the battery. After the foaming has stopped, flush with clean water and dry with a clean cloth.

Electrical System Fuses

The fuses protect the electrical circuits of the vehicle. They are located in a sealed fuse block inside the engine compartment. Return your vehicle to an ARGO dealer for inspection of the electrical circuit if a fuse blows repeatedly.

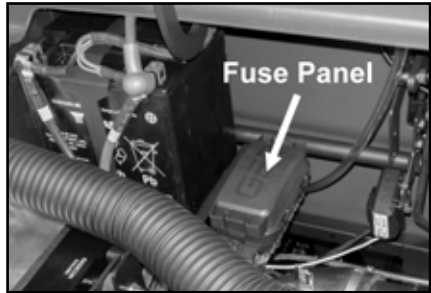

MAIN RELAY		LIGHTS ENABLE RELAY		ACC. RELAY	OPTION - A RELAY	HOOD FAN RELAY
ECM 10 A	GAUGE 2 A	BRAKE FAN 7.5 A	HOOD FAN 20 A	OPTION - B RELAY	START ENABLE RELAY	
STARTER 10 A	BILGE SINGLE 5 A DUAL 10A	USB OUTLET 5 A	HORN 10 A			
HIGH BEAM 15 A	WINCH 5 A	DASH 7.5 A	LOW BEAM RELAY	HIGH BEAM RELAY	STARTER RELAY	
LOW BEAM 15 A	WIPER 15 A	CHAIN OILER 10 A				

FUSE PANEL 600-0157

Maintenance Information

Spark Plugs

Remove and inspect the spark plugs after every 100 hours of operation. Clean the plugs and reset the gap per specification.

Replace the spark plugs if the electrodes are corroded or damaged or if the insulator is cracked. Use the correct plug for the engine as detailed in the engine owner's manual.

Re-install the spark plugs carefully, taking care to start the threads properly. Torque the plugs to 18 - 22 ft. lbs (25 to 30 N-m). Do not over tighten.

Spark Arrester

Cleaning the Spark Arrester



CAUTION

After operating the engine, do not touch any part of the exhaust system until it has had sufficient time to cool!

1. The spark arrester should be removed, cleaned and inspected every 50 hours of operation.
2. The spark arrester is between the muffler and tail pipe. Remove the tail pipe assembly by disconnecting the two springs from the muffler attached to the tail pipe.
3. Take out the screen-type spark arrester assembly.
4. Shake loose particles out of the screen assembly.
5. Clean the screen with a wire brush. (Soak it in oil solvent if necessary.)
6. If any breaks in the screen or weldments are discovered, replace the assembly.
9. Once clean and dry, reverse the above steps to reinstall.



Instant Torque Drive System



WARNING

Do not attempt to adjust, repair or replace the drive belt, clutches or any moving part while the engine is running. Doing so will cause injury. Before servicing the vehicle, disconnect the battery to prevent accidentally starting the engine.

Keep the engine compartment hood, clutch guard and kick panel securely in place when the engine is running. Severe injury can result if the drive belt, clutch components or other moving parts come loose.

If engine compartment inspection is necessary while the engine is running, use **EXTREME CAUTION!** Keep engine RPM low. Avoid standing directly in line with moving components. Use a mirror to view the components.

Maintenance Information

Drive Belt

The drive belt transmits power from the driver clutch (on the engine) to the driven clutch (on the transmission). These components are located on the left side of the engine compartment

Check the drive belt after every 25 hours of operation, or whenever there is a noticeable reduction in clutch performance.

Replace the belt when:

- the top width of the belt has worn to 1-1/16" (27mm)
- cracks, fraying or shredding is apparent
- it becomes contaminated with oil, grease, etc.

Drive Belt Adjustment

There is no drive belt adjustment with the Instant Torque Drive System (ITDS). Drive belt center to center is fixed. If any clutch performance issues arise, please contact your nearest ARGO dealer.

To Remove the Drive Belt



CAUTION

This procedure requires a specialized tool to spread the driven clutch sheaves.

1. Remove the bolt securing the driven clutch to the input shaft and insert it through a piece of flat bar stock.
2. Thread the bolt into the driven clutch until the clutch sheaves spread far enough to easily remove the drive belt.

To Install the Drive Belt:



CAUTION

This procedure requires a specialized tool to spread the driven clutch sheaves.

1. Remove the bolt securing the driven clutch to the input shaft and insert it through a piece of flat bar stock.
2. Thread the bolt into the driven clutch until the clutch sheaves spread far enough to easily install the drive belt.



Location of drive clutches and drive belt.

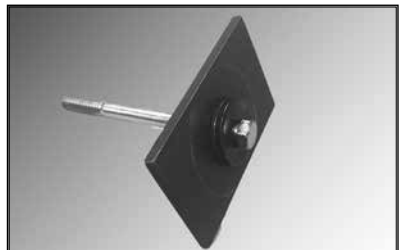

Maintenance Information

3. To install the drive belt, position the belt around the drive clutch first.
4. Ease the belt over the edge of the fixed face on the driven clutch and carefully thread the belt over the top while turning both drive and driven clutch clockwise.
5. Remove the clutch tool and reinstall the mounting bolt. Torque the bolt to 31 ft lb (42 N-m).



NOTE:

Drive Belt alignment and tension are pre-set and not adjustable. They are critical for proper operation of the drive system. Return the vehicle to an ARGO dealer if service is required.

Clutch Maintenance

Disassembly and repair of the driver and driven clutch requires special tools. Return the vehicle to an authorized ARGO dealer if the clutch units need servicing. The following indicates that clutch service might be required:

- a drop in vehicle performance
- the clutch does not shift smoothly
- the clutch sticks during vehicle operation
- the drive belt wears rapidly
- the vehicle vibrates severely during operation
- the vehicle does not accelerate when the engine speed is increased with the transmission in gear
- transmission will not shift smoothly into gear at engine idle.

Driven Clutch Inspection

Inspect the nylon sliders every 100 hours. The nylon sliders are mounted in the driven clutch moveable pulley. When the clutch shifts, the cam moves on the nylon sliders.

Replace the nylon sliders before there is aluminium to aluminium contact between the cam and the movable pulley. Driven clutch disassembly is required to replace the nylon sliders properly. Return the vehicle to an ARGO dealer for service.



Location of the sliders.

Maintenance Information

Drive Chains

Roller chain “stretch” results from wear to the chain pins and bushings because of the loss of lubricant.

To prevent sprocket damage and unnecessary breakdowns, see an authorized ARGO dealer to replace the chains when:

- the chain tensioner can no longer take up the chain slack.
- the chain is rubbing on a frame cross member.
- the chain is seized due to rust and lack of lubrication.
- the chain climbs the sprocket teeth, especially noticeable when turning.

Drive Chain Tensioner System



CAUTION

Check for proper chain tensioner operation every 10 hours of vehicle operation.

The scissor style chain tensioning system consists of a torsion springed upper and lower slider block. As the chain wears, the chain tensioning mechanism adjusts automatically by squeezing the chain from both top and bottom. Replace chains when upper and lower chain start to contact each other.

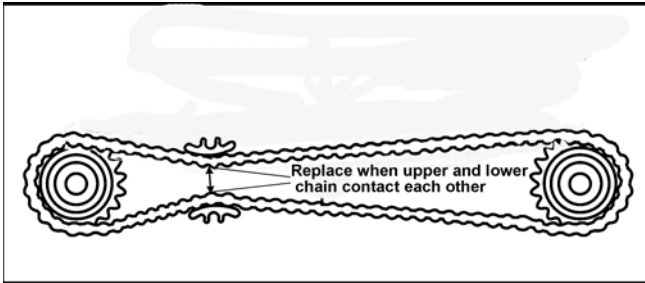

Each chain tensioner has a single slider block. Inspect the slider blocks for wear every 10 hours. Have your authorized ARGO dealer replace the blocks when the wear groove, as shown, measures 1/4" (6mm).

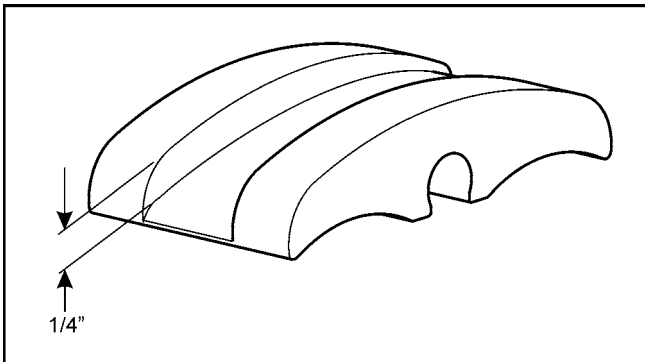

Wear groove on the slider block.

Maintenance Information

Tires & Axles

Damaged or improperly inflated tires can cause the vehicle to pull to one side or affect vehicle handling. For any tires that may require replacement, see your authorized ARGO dealer.

Suggested inflation is based on the type of rim in the wheel, and are listed below.

Standard 9" Steel Rim	2.5 to 3.5 psi (17 to 24 kPa)
Offset 9" Steel Rim	2.5 to 3.5 psi (17 to 24 kPa)
Offset 9" Aluminium Beadlock	1.5 to 3.5 psi (10 to 24 kPa)
Offset 9" Steel Beadlock Rim	1.5 to 3.5 psi (10 to 24 kPa)

The maximum operating pressure for all tires is 7.0 psi (48 kPa).

A special low pressure tire gauge (ARGO Part No. 619-10) is available from your ARGO dealer.

Changing Tire Pressure For Different Terrain Conditions

The tire pressure should be adjusted according to differences in terrain. Observance of these guidelines will lead to less wear & tear on both vehicle and tires. The operator should equip the vehicle with a low pressure tire gauge (Part No. 619-10) and with a hand pump.

Recommended Guidelines For Terrain

Soft Ground:

Low Pressure • On soft terrain, use lower pressure.

Hard Ground:

Higher Pressure • On hard terrain and water, use higher pressure.

Rocky Ground:

Highest Pressure • On rough or rocky terrain, fill to, but not more than the recommended range indicated on the tire sidewall.

This will reduce the possibility of tires and rims being damaged during heavy duty applications.

It is also important to observe the recommended load capacities of your vehicle when travelling on different kinds of terrain. For load capacities of your particular vehicle, see Specifications Section in this Operator's Manual.



CAUTION

It is ultimately the responsibility of the operator to determine a **SAFE MAXIMUM** load capacity in accordance with the driving terrain, conditions and vehicle specifications.

Maintenance Information

Axle Bearing Mounting

The axles are mounted to your Aurora using special cork gaskets between the flanged bearings and the outside surface of the lower body.

During the initial run-in period, the gasket material may relax causing the nuts to loosen slightly. These should be checked and re-tightened after initial 10 hours of use and then after every 100 hours. Tighten in a criss-cross pattern to 30 ft lb (40.5 N-m).

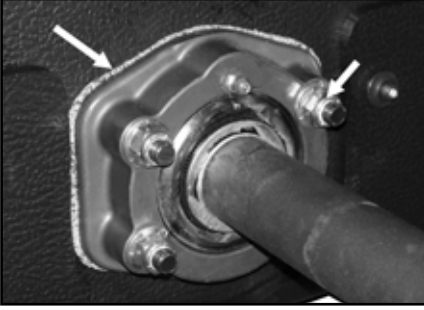

Re-tightening nuts (mid axles).

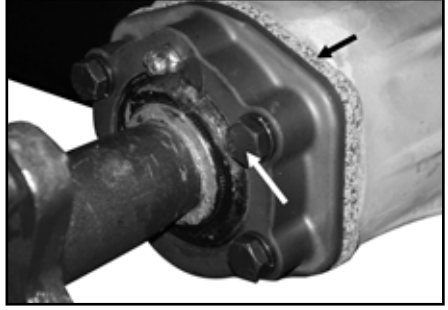

Re-tightening bolts (front/rear axles).

Hydraulic Brakes

General

Although the hydraulic brake system is self adjusting, the following require periodic attention:

Brake Fluid Level

After every 50 hours of operation, check the brake fluid level by removing the master cylinder covers.



CAUTION

Thoroughly clean the master cylinder cover and surrounding area before removal.

Locate the master cylinders in the engine compartment near the steering column. When adding fluid, fill to mark on reservoir.



Hydraulic brake cylinder and fluid level.

If the brake fluid is below this level:

1. Add only fresh clean ARGO Brand Brake Fluid - DOT 4 (ARGO Part No.130-108) to the correct level.
2. Replace the cover on each master cylinder, making sure the rubber gaskets are properly seated before tightening. Tighten snug by hand only.



CAUTION

Do not overfill the brake master cylinders. Overfilling can cause seal damage.

Maintenance Information

Changing Brake Fluid

Inspect the fluid for degradation (discolouration or particles) during normal fluid level inspections. If discolouration has occurred, the brake fluid system should be drained, flushed and refilled with fresh brake fluid. An authorized ARGO dealer will perform these operations for you.

Hydraulic Brake Pad Inspection

Inspect the steering brake pads after every 25 hours of operation. Worn, glazed or contaminated brake pads affect the efficiency of the brake system. To inspect the pads, first remove the kick panel.

To remove the kick panel:

1. Remove the six (6) fasteners securing the kick panel using a socket and ratchet wrench.
2. Pull the kick panel rear-ward moving the throttle cable clear of the area at the steering column that it is routed through.
3. Lift the kick panel clear of the driving compartment.

Steering Brake Pad Inspection Procedure

With the kick panel removed, both hydraulic brake calipers are visible. Inspect all four (4) brake pads. Have an authorized ARGO dealer replace the pads when:

- the brake lining material molded to each metal backing plate is worn to 0.10" thickness.
- the pads are glazed and brake performance is affected.
- the pads are contaminated with lubricant, and brake performance is affected.

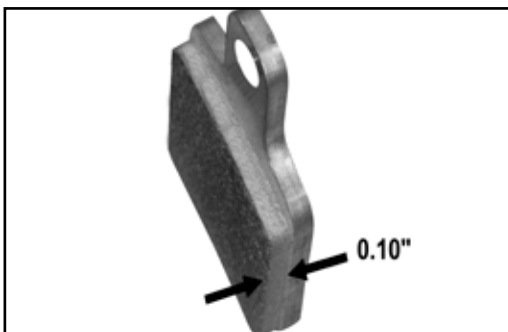

Brake pad wear, hydraulic brakes

To replace the kick panel:

1. Position the kick panel in the driving compartment.
2. Slide in the bottom of the kick panel first and route the throttle cable through the open area at the steering column.
3. Push in the top of kick panel up against the tabs located on the left and right hand side of the dash support.
4. Reinstall the six (6) socket head fasteners that secure the kick panel.



WARNING

Do NOT operate the ARGO with the kick panel removed.

Maintenance Information

Service Brake Pad Inspection

The vehicle is equipped with a hydraulic hand brake system. This consists of an independent set of hydraulic brake calipers and brake discs. The master cylinder is mounted on the left side steering bar with a fluid level viewing window.

Monitor the hand brake fluid on a regular basis. If fluid level needs replenishing, remove the cover and ensure the level is to the "top" level mark.



CAUTION

If the cover needs to be removed to replenish or service the system, thoroughly clean the cover and surrounding area before removing to avoid any contamination to the brake system.

Inspect all brake hoses and brake fittings at both hand brake and hydraulic calipers for any signs of brake fluid leaks.

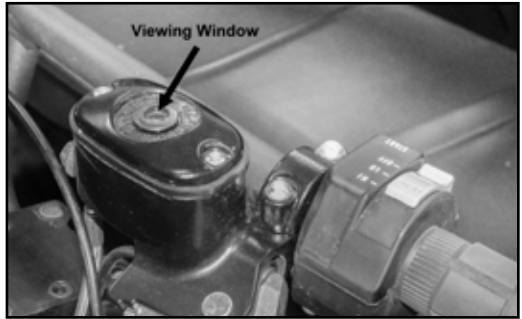

Service Brake Pad Inspection Procedure

Inspect the brake pads after every 25 hours of operation. Worn, glazed or contaminated brake pads affect the efficiency of the brake system. To inspect the pads, first remove the kick panel.

To remove the kick panel:

1. Remove the six (6) fasteners securing kick panel using a socket wrench.
2. Pull the kick panel rear-ward moving the throttle cable clear of the area at the steering column that it is routed through.
3. Lift the kick panel clear of the driving compartment.

With the kick panel removed, both hand brake hydraulic brake calipers are visible. Each caliper has two (2) brake pads.

Have an authorized ARGO dealer replace the pads when:

- the brake lining material molded to each metal backing plate is worn to 0.035" (1/32") thickness.
- the pads are glazed and brake performance is affected.
- the pads are contaminated with lubricant, and brake performance is affected.

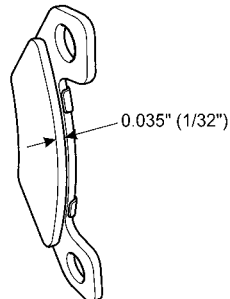

Maintenance Information

To replace the kick panel:

1. Position the kick panel in the driving compartment.
2. Slide in the bottom of the kick panel first and route the throttle cable through the open area at the steering column.
3. Push in the top of kick panel up against the tabs located on the left and right hand side of the dash support.
4. Reinstall six (6) socket head fasteners that secure the kick panel.



WARNING

Do NOT operate the vehicle with the kick panel removed.

Parking Brake Adjustment

See your authorized ARGO dealer for any adjustment to your parking brake system. The parking brake system has been factory adjusted to ensure proper braking effectiveness. However, **before the vehicle is used for the first time**, and after every 25 hours of operation, brake effectiveness **must** be inspected.



WARNING

The use of an improperly adjusted parking brake is a serious hazard, and could lead to vehicle damage or personal injury.

The hand brake lever should be adjusted such that when pulled up firmly it is capable of holding the vehicle from rolling on a grade. It should also ensure a good braking response when applied to stop the vehicle during normal operation.

Steering Brake Plunger Adjustment



CAUTION

It is critical that the master cylinder pistons are adjusted properly when the steering handlebars are in the centered position. Overheating of the brake system could occur due to an improperly adjusted brake system. Any suspected issues related to the steering performance of your vehicle should be immediately addressed by a local authorized ARGO dealer.

Engine Cooling & Exhaust System

Engine cooling air is drawn in on the right side of the engine compartment and expelled with the exhaust on the left side. Keep all ducting and screening in place. Inspect and ensure all screening is free of debris. Restriction of air flow can cause serious damage to your engine. Check the area around the exhaust system periodically for accumulated debris. Failure to inspect and clean the exhaust system on a regular basis may cause damage.



WARNING

If the vehicle is equipped with an enclosed cab of any sort, make sure there is plenty of ventilation to avoid exposure to exhaust and engine fumes. Engine exhaust contains carbon monoxide; an odourless, colourless toxic gas that will cause serious personal injury or death.

Maintenance Information

Inspect the exhaust system periodically for worn or damaged components. Listen for a change in exhaust or engine sound that may indicate a dangerous exhaust leak. If a leak is detected, have the exhaust system repaired immediately before further use.

The tail pipe exiting through the left side of the upper body becomes very hot when the vehicle is operated.



WARNING

DO NOT ALLOW ANYONE TO TOUCH THE EXHAUST COMPONENTS. A SEVERE BURN CAN RESULT.

Engine Idle Adjustment

Your engine has an electronic governor and idle is controlled by the ECU. See your ARGO dealer for any governor or idle related issues.

SECTION 10

Troubleshooting

MALFUNCTION (SYMPTOM)	PROBABLE CAUSE	CORRECTIVE ACTION
Electric starter inoperative	<ol style="list-style-type: none">1. Loose electrical connections2. Battery charge low3. Faulty starter motor	<ol style="list-style-type: none">1. Clean and re-tighten electrical connections.2. Recharge battery or replace as necessary.3. Return the vehicle to an authorized ARGO dealer for service
Engine turns over but will not start	<ol style="list-style-type: none">1. Fuel tank is empty2. Blocked fuel or air filter3. Spark plug defective or fouled4. Ignition system inoperative5. Insufficient compression	<ol style="list-style-type: none">1. Refill fuel tank2. Remove obstruction or replace filter as necessary3. Clean and re-gap or replace4. Have vehicle serviced by a properly trained mechanic5. Return the vehicle to an authorized ARGO dealer for service
Engine will not run		<ol style="list-style-type: none">1. Return the vehicle to an authorized ARGO dealer for service
Vehicle will not move or turn	<ol style="list-style-type: none">1. Transmission in neutral or not properly engaged in gear2. Drive belt worn3. Clutch not engaging4. Transmission failure5. Brakes not functioning6. Idler sprocket damaged	<ol style="list-style-type: none">1. Place gear shift properly in gear2. Replace belt if worn excessively3. Return the vehicle to an authorized ARGO dealer for service4. Return the vehicle to an authorized ARGO dealer for service5. Adjust caliper or replace brake pads6. Repair or replace
Vehicle pulls to the right	<ol style="list-style-type: none">1. Right tire pressure too low2. Left tire pressure too high3. Right brake engaged4. Right side drive chain broken	<ol style="list-style-type: none">1. Inflate all tires to the correct pressure2. Inflate all tires to the correct pressure3. Make sure the handlebar is held parallel to the dash. Adjust brake assembly if required4. Repair or replace
Vehicle pulls to the left	<ol style="list-style-type: none">1. Left tire pressure too low2. Right tire pressure too high3. Left brake engaged4. Left side drive chain broken	<ol style="list-style-type: none">1. Inflate all tires to the correct pressure2. Inflate all tires to the correct pressure3. Make sure the handlebar is held parallel to the dash. Adjust brake assembly if required4. Repair or replace
Vehicle does not shift into gear		<ol style="list-style-type: none">1. Return the vehicle to an authorized ARGO dealer for service

Troubleshooting

MALFUNCTION (SYMPTOM)	PROBABLE CAUSE	CORRECTIVE ACTION
Hand brake failure	<ol style="list-style-type: none"> 1. Worn brake pads, brake caliper adjustment 2. Leaking caliper or brake lines 	<ol style="list-style-type: none"> 1. Change pads or adjust brake cable 2. Return the vehicle to an authorized ARGO dealer for service
Severe vibration	<ol style="list-style-type: none"> 1. Engine mounts loose 2. Drive or driven clutch or engine defective 3. Axle bent 4. Wheel rim bent 5. Worn or damaged drive belt 	<ol style="list-style-type: none"> 1. Return the vehicle to an authorized ARGO dealer for service 2. Return the vehicle to an authorized ARGO dealer for service 3. Replace 4. Replace 5. Replace. Clutch service may be required
Water leaks into lower body	<ol style="list-style-type: none"> 1. Leak has developed at the axle bearing flange 2. Bearing flange seal damaged 3. Water leaking in around the outer bearing flange bolts 4. Lower body is cut or punctured 5. Drain plugs not in place 	<ol style="list-style-type: none"> 1. Replace the bearing flange gaskets 2. Replace the bearing flange seal 3. Caulk under bolt heads with silicone sealer 4. Repair or replace vehicle lower body 5. Secure drain plugs
Tire leaks air	<ol style="list-style-type: none"> 1. Tire is punctured 2. Tire is not properly seated on bead 3. Position of air leak is not obvious 4. Defective valve 	<ol style="list-style-type: none"> 1. Remove tire from rim and repair the hole with a radial tire patch or install a tube 2. Deflate tire and carefully push tire bead off rim. Clean the rim bead area to remove dirt. Inflate tire. 3. Submerge tire and rim in water tank. Air may be escaping through the rim halves or the valve stem. Repair as needed. 4. Replace defective valve
Vehicle does not respond well to steering input (left or right)	<ol style="list-style-type: none"> 1. Air in hydraulic system 2. Leak in system 	<ol style="list-style-type: none"> 1. Return the vehicle to an authorized ARGO dealer for service 2. Return the vehicle to an authorized ARGO dealer for service
Brakes ineffective	<ol style="list-style-type: none"> 1. Pads have overheated and glazed 2. Pads worn beyond 0.10" 3. Pads are contaminated with lubricant 	<ol style="list-style-type: none"> 1. Return the vehicle to an authorized ARGO dealer for service 2. Replace 3. Return the vehicle to an authorized ARGO dealer for service
Vehicle makes abnormal sound when turning right or left	<ol style="list-style-type: none"> 1. Idler chains worn or loose 2. Drive chains worn or loose 	<ol style="list-style-type: none"> 1. Adjust or replace idler chains as required 2. Adjust or replace drive chains as required
Vehicle does not steer left or right	<ol style="list-style-type: none"> 1. Worn or contaminated brake pads 2. Leaking caliper or brake lines or air in system 	<ol style="list-style-type: none"> 1. Replace pads 2. Return the vehicle to an authorized ARGO dealer for service

SECTION 11

Cleaning and Storage

Cleaning The Vehicle

Wash the vehicle body with a household detergent and rinse with water. Flush dirt out of the lower body by using a high pressure sprayer or garden hose after removing the drain plugs. After the bottom of the vehicle is dry, lubricate the drive chains with ARGO chain Lube. Make sure the drain plugs are reinstalled.

Salt/Brackish Water

When using the vehicle in salt/brackish water, it is recommended to rinse and clean the vehicle after daily use to minimize possible corrosion.

Storing The Vehicle

When the vehicle is stored for an extended period, the following preparation is required:

Clean the Vehicle

Remove all dirt and water from the vehicle body as directed above.

Remove the drain plugs if the vehicle is not fully sheltered from the elements.



CAUTION

Any water accumulation in the vehicle will, over time, destroy chains, sprockets and bearings. Grease all bearings and flanges.

NOTE:

Bearing corrosion due to inadequate preparation and lubrication for storage is the leading cause of premature bearing failure.

Drain the Fuel System

Insert a siphon hose into the gas tank through the filler neck and drain the gasoline. Start the engine and run it until all fuel in the system is consumed.

OR

Add fuel stabilizer (ARGO Part No. 130-107) to the fuel tank and fill with fresh gasoline. Run the engine for a few minutes to allow the treated fuel to reach the carburetor.

Prepare the Battery for Storage

Remove the battery from the vehicle. Clean it and charge it with a battery charger. Coat the battery terminals with a multi-purpose grease to prevent corrosion. Store the battery in a cool dry place.



WARNING

Do not store the battery near flames or sparks. Batteries can explode if exposed to flames or sparks, causing serious personal injury.

Recharge the battery monthly.

Cleaning And Storage

Protect the Electrical System

Spray the wiring harnesses and all the electrical connections with a silicone based lubricant (WD40 or equivalent) to prevent corrosion.

Carefully inspect the wiring for loose connections, bare wires or corrosion. Repair as necessary.

Raise the Vehicle



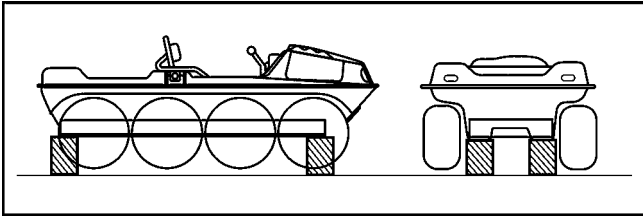







Place blocks under the front and rear of the vehicle to raise the tires off the ground. The blocks must be placed under the frame members to prevent body damage.















Correct placement of blocks

SECTION 12









Potential Hazards

	POTENTIAL	WHAT CAN HAPPEN	HOW TO AVOID THE HAZARD
	Operating the vehicle without reading and understanding the Operator's Manual	The risk of accident is greatly increased if the operator does not know how to operate the vehicle properly in different situations and on different types of terrain.	New or inexperienced operators should read and understand the Operator's Manual. They should then regularly practice the operating techniques described in this Operator's Manual.
	Allowing anyone under age 16 to operate this vehicle.	Children under the age of 16 may not have the skills, abilities, or judgement needed to operate the vehicle safely and may be involved in an accident causing severe injury or death.	No one under the age of 16 should be allowed to operate the vehicle.
	Operating or riding as a passenger in the vehicle without wearing an approved helmet, eye protection, and protective clothing.	Operating or driving without an approved helmet increases the chance of severe head injury or death in the event of an accident. Operating or driving without eye protection can result in an accident and increases your chances of a severe injury in the event of an accident.	Wear an approved helmet and eye protection when driving or riding in the vehicle.
	Operating the vehicle after or while consuming alcohol or drugs.	Could seriously affect your judgement, cause you to react more slowly, and affect your balance and perception. This could result in an accident.	Never allow anyone under the influence of alcohol or any other intoxicating substance to drive or ride in the vehicle. Never use with drugs or alcohol.
	Carrying passengers in the dump box.	Riders can fall off causing serious injury or death.	No riders in the dump box.
	Carrying cargo when using the vehicle in water.	Argo vehicles may sink if they fill with water, resulting in injury or drowning to driver and passengers. If the vehicle upsets or swamps, exposure in cold water significantly reduces the chance of survival.	Be especially cautious when operating a loaded vehicle (cargo and/or passengers) in water. Observe the capacity limits. Do not enter water if the vehicle is overloaded. Use extra caution when operating the vehicle in cold water.
	Carrying cargo in the dump box when used in water.	Greatly reduces your ability to balance and control the vehicle in the water. Could cause an accident, including capsizing and sinking, resulting in injury or drowning to driver and passengers.	Do not use the dump box equipped vehicle in water.
	Operating the vehicle in water without drain plugs properly installed.	Will cause the vehicle to fill with water and cause it to capsize or sink, which could result in injury or drowning to driver and passengers.	Always make sure the drain plugs are properly installed in the vehicle as described in the Operator's Manual.
	Using the vehicle to tow anything in the water other than an Argo amphibious trailer.	Greatly reduces your ability to balance and control the vehicle in the water. Could cause an accident, including capsizing and sinking, which could result in injury or drowning to driver and passengers.	Never tow anything other than an Argo amphibious trailer when the is used in water. Keep cargo low and centered in the trailer, especially if used in water.
	Operating the vehicle in rough water.	Greatly reduces your ability to balance and control the vehicle in the water. Could cause an accident, including capsizing and sinking, which could result in injury or drowning to driver and passengers.	Do not attempt to navigate any body of water with a strong current. Avoid water operation under windy conditions. Do not attempt to cross large bodies of water. Stay close to shore in case of emergency and you have to leave the water.
	Operating or driving the vehicle in water without the occupants wearing an approved personal flotation device (PFD).	If you lose control of the vehicle in water and it capsizes and sinks, the driver and passengers may be injured or drown.	All occupants must wear an approved personal flotation device (PFD) or life jacket while travelling in water.

Potential Hazards

	POTENTIAL	WHAT CAN HAPPEN	HOW TO AVOID THE HAZARD
	Operating the vehicle with improper tires or with improper or uneven tire pressure.	Use of improper tires on the vehicle, or operation of the vehicle with improper or uneven tire pressure may cause loss of control increasing your risk of an accident.	Always use the size and type tires specified in this Operator's Manual for this Vehicle. Always maintain proper tire pressure as described in this Operator's Manual.
	Operating the Vehicle with improper modifications.	Improper installation of accessories or modification of the Vehicle may cause changes in handling which in some situations could lead to an accident.	Never modify the Vehicle through improper installation or improper use of accessories. All parts and accessories added to this Vehicle should be genuine Argo components designed for use on the Vehicle and should be installed and used according to instructions. If you have questions, consult an authorized Argo dealer or contact Ontario Drive & Gear Limited at 1-519-662-4000
	Applying brakes suddenly when going downhill.	Sudden braking can cause the vehicle to roll over forward.	Gently apply the brakes to control downward vehicle speed. Do not jam on the brakes while travelling downhill.
	Operating the Vehicle on paved surfaces.	Pavement may seriously affect handling and control.	Do not drive your vehicle on asphalt or concrete roadways.
	Operating Vehicle on public streets, roads or highways.	A collision can occur with another vehicle.	Never drive on public roads.
	Operating at excessive speeds.	Personal injury or vehicle damage may result.	Do not drive the vehicle at high speeds over unfamiliar or rough terrain. Never operate at speeds too fast for your skills or the conditions.
	Failure to use extra care when operating the Vehicle on unfamiliar terrain.	Personal injury or vehicle damage may result.	Do not drive the vehicle at high speeds over unfamiliar or rough terrain.
	Failure to use extra care when operating on rough, slippery or loose terrain.	Could cause loss of traction or vehicle control, which could result in an accident, including an overturn.	Do not operate on rough, slippery or loose terrain until you have learned and practised the skills necessary to control the Vehicle on such terrain.
	Turning improperly.	When turning, the back of the vehicle swings to the opposite direction of the turn, creating a risk of hitting persons or objects. Sharp turns, especially at high speeds or when heavily loaded, may cause the vehicle to roll over.	Always take precautions when making turns to avoid rolling the vehicle or hitting persons or objects. Slow the vehicle down before making a turn. Do not apply the brakes too suddenly.
	Driving on inclines with a loaded vehicle.	Heavy loads and high loads decrease the stability of the vehicle and may cause it to roll.	Use extreme CAUTION when negotiating inclines with a loaded vehicle. Be prepared to shift occupant weight and load forward or have passengers get out of the vehicle to walk up an incline.
	Going downhill improperly.	Sudden braking can cause the vehicle to roll over forwards.	Avoid steep declines when possible. When a steep decline cannot be avoided, shift occupant weight to the rear of the vehicle to prevent the vehicle from rolling over.
	Improperly crossing hills or turning on hills.	Side slope operation greatly increases the risk of rolling the vehicle over sideways. Prolonged side slope operation may cause engine damage.	Do not drive your vehicle across the side of a hill. Observe the engine angle of operation limitations in Section 5.
	Stalling or rolling backwards while climbing a hill.	Could cause loss of control which could lead to an accident including an overturn.	Try to avoid steep hills. Maintain steady speed when climbing a hill. If you lose all forward speed: <ul style="list-style-type: none"> - keep weight uphill - lean toward the hill - slowly coast backwards down the hill using the handlebar brake

Potential Hazards

	POTENTIAL	WHAT CAN HAPPEN	HOW TO AVOID THE HAZARD
	Improperly operating over obstacles.	Personal injury or vehicle damage may result.	Before operating in a new area, check for obstacles. Never attempt to drive over large obstacles such as large rocks or fallen trees. When you go over obstacles always follow proper procedures as described in this Operator's Manual.
	Skidding or sliding.	You may lose control of the Vehicle. You may also regain traction unexpectedly which may cause the Vehicle to overturn.	Learn to safely control skidding or sliding by practising at slow speeds and on level, smooth terrain. On extremely slippery surfaces, such as ice, go slowly and be very cautious in order to reduce the chance of skidding or sliding out of control.
	Improperly operating in reverse.	You could hit an obstacle or person behind you resulting in serious injury.	Carefully practice backing up and turning in an open area until you become accustomed to this procedure. Take precautions to avoid hitting persons or objects.
	Use of the holding brake as a parking brake.	The holding brake system is not a parking brake, and therefore is not designed to hold the vehicle in place for long periods of time. The holding brake is for short term use only. The hydraulic brake pressure could drop over time, releasing the brakes, allowing the vehicle to roll into persons or objects, causing serious injury.	When parking on an incline, apply the emergency/parking brake, leave the vehicle in gear, turn the engine off and block the vehicle's wheels.
	Using the kick panel to brace your knees.	Damage to the kick panel and serious personal injury can result from the driven clutch wearing through the kick panel.	Do not push against the kick panel with your knees.
	Running the engine in a closed building or confined area.	Engine exhaust gases contain poisonous carbon monoxide. Carbon monoxide is odourless, colourless and can cause serious injury or death.	Never start or run the engine in a closed building or confined area.
	Adding fuel while the engine is running or hot.	Gasoline is extremely flammable and can explode under certain conditions, causing serious injury or death.	Do not add fuel while the engine is running or hot.
	Filling outboard motor fuel tanks while they are in the Vehicle.	Gasoline is extremely flammable and can explode if ignited, causing serious injury or death.	Fill outboard motor fuel tanks outside of the vehicle. Wipe up any spilled fuel immediately. Do not carry or store fuel tanks in a vehicle equipped with a cab or convertible top unless adequate ventilation is provided.

SECTION 13

Warranty



LIMITED WARRANTY

Ontario Drive & Gear Limited (hereinafter "ARGO") extends a limited warranty on each new ARGO XTV and on each genuine ARGO part and accessory sold by an authorized ARGO dealer. The limited warranty on an ARGO XTV is provided to the original retail purchaser; however, the balance of the unused warranty may be transferred to another party through an ARGO dealer, but any such transfer will not extend the original term of the warranty. Warranty coverage is limited to the country in which the original retail purchase occurs and to the original retail purchaser resident in that country or, if transferred to a resident in that country for the balance of the remaining warranty.

The warranty is validated upon examination of said parts by ARGO or an authorized ARGO dealer. ARGO reserves the right to inspect such parts at its factory for final determination if warranty should apply. ARGO will repair or replace, at its option (including any related labor charges), any parts that are found to be warrantable in material or workmanship. This repair work must be done by an authorized ARGO dealer. No transportation charges, rental charges, or inconvenience costs will be paid by ARGO.

ARGO does not assume any liability for incidental or consequential damages.

WARRANTY COVERAGE PERIOD

1. Standard Warranty - 1 year or 1000 hours from the date of sale, whichever comes first.
2. Powertrain Warranty - 3 years or 3000 hours from date of sale, whichever comes first.
 - a. Includes coverage for defects in material or workmanship of the engine, transmission, and drivetrain.

Argo Promotional Extended Warranty provided at the time of sale will follow the Standard Warranty guidelines and coverage. Excludes batteries.

The warranty does not cover normal wear, abuse, or corrosion.

WARRANTY LIMITATIONS AND EXCLUSIONS

This ARGO limited warranty will become null and void if:

1. Failure to perform the proper break-in procedure and all related maintenance, storage procedures (if stored for extended periods), and/or service as recommended in the Operator's Manual.
2. Repairs and/or adjustments made by anyone other than an authorized ARGO dealer unless instructed by ARGO.
3. Any modification, addition, or removal of parts unless instructed to do so by ARGO.
4. Removal of the engine for use in another vehicle.
5. Use of improper fuels, lubricating oils, or spark plug(s).
6. Vehicle has been involved in an accident or subject to misuse, abuse, or negligent operation, including overloading.
7. Use of the vehicle in any way for racing purposes.
8. Removal or mutilation of the Product Identification Number or Engine Serial Number.



9. Damage due to improper transportation.
10. Use of aftermarket or unapproved parts, accessories or attachments not sold by ARGO.
11. Damage caused by Acts of God, such as storm damage, hail, lightning, and other environmental conditions.
12. Collision, fire, theft, freezing, vandalism, riot, explosion, or objects striking the vehicle.
13. Tampering with the vehicle's hour meter.

In consideration of the foregoing, any implied warranty is limited in duration to the warranty periods set forth. This warranty gives you specific legal rights, and you may also have other rights which vary from state/province to state/province and country to country. Some jurisdictions do not allow limitations on how long an implied warranty lasts, so the above limitations may not apply to you.

WARRANTY PROCEDURE / OWNER RESPONSIBILITY

At the time of sale, a Training Certificate (if applicable) or an Owner Registration form is to be completed by the selling dealer and consumer. The receipt of the form by ARGO is a condition precedent to warranty coverage. It is the selling dealer's responsibility to retain and/or submit appropriate electronic registration to initiate warranty coverage.

The selling dealer is responsible to furnish the consumer a signed copy of the form which must be presented to the dealer when requesting warranty service. The registration form is the consumer's proof of ownership and warranty eligibility. The form is to be used by the dealer to validate the warranty claim. Retain your copy of the Owner Registration form and keep it in a safe place.

When warranty repair is suspected, the vehicle should be taken to an authorized ARGO dealer, who has the primary responsibility to perform warranty repairs.

The authorized ARGO dealer will examine the vehicle or part to determine if a warrantable condition exists. If a warrantable condition appears to exist, the dealer will repair or replace, at ARGO's option, including any related labor costs, all parts that are found to be warrantable and any other parts which the warrantable part caused to be damaged.

It is the owner's responsibility to maintain and service the vehicle in accordance with ARGO's recommendations in the Operator's Manual. To protect yourself and your vehicle, follow all safety and service tips. ARGO will NOT warrant repairs required as a result of not performing standard operator maintenance, storage procedures, and service as outlined in the Operator's Manual.

Should you have any questions concerning the warranty, contact an authorized ARGO dealer.

EPA EMISSIONS CONTROL SYSTEM WARRANTY:

LIMITED WARRANTIES EMISSION CONTROL SYSTEMS:

ARGO warrants to the owner of any 2024 and subsequent model year XTV that the XTV is designed, built and equipped to conform at the time of sale with all applicable emission standards and is free from defects in materials and workmanship which would cause it to fail to conform with applicable requirements during the specified time and mileage limits.

A qualified repair shop or person of the owner's choosing may maintain, replace, or repair emission control devices and systems with original or equivalent replacement parts. However, warranty, recall and all other services paid for by ARGO must be performed at an authorized ARGO service center except for the emergency condition described below.

Your Warranty Rights and Obligations:

In the United States and Canada, new XTVs must be designed, built and equipped to meet stringent Federal anti-smog standards. ARGO must warrant the emissions control system on your XTV for the periods of time listed below, provided there has been no abuse, neglect or improper maintenance of your XTV. Your emissions control system may include parts such as the sensors, the ignition and the engine computer. Also included may be hoses, connectors and other emissions-related assemblies. Where a warrantable condition exists, ARGO will repair your XTV at no cost to you, including diagnosis, parts, and labor.

Owner's Responsibility:

As the XTV owner, you should also be aware that ARGO may deny you warranty coverage if your vehicle or a part has failed due to abuse, neglect, improper maintenance or unapproved modifications. If you have any questions regarding your warranty rights and responsibilities or if an authorized ARGO dealer cannot repair your XTV or honor your claim within a reasonable period of time, contact ARGO for assistance at 1-218-683- 5366.

You must operate and maintain your XTV according to the requirements of the Operator's Manual including the maintenance schedule. This schedule is designed to keep your XTV emission control systems functioning properly and safely. You should keep receipts and records of maintenance and service but ARGO will not deny a warranty claim solely because of lack of maintenance records.

If an ARGO service center is not available within 100 miles, ARGO will reimburse you for those emergency repairs, including diagnosis, covered by the Emissions Warranties. Labor reimbursement is at a geographically-appropriate hourly labor rate for ARGO recommended time allowance. For reimbursement, present the replacement parts and a copy of the paid receipt to ARGO.

The use of replacement parts not equivalent to the original parts may impair the effectiveness of your XTV emissions control systems. If such a replacement part is used in the maintenance or repair of your XTV and an authorized ARGO dealer determines it is defective or caused a failure of a warranted part, your claim for repair to bring your XTV into compliance with applicable standards may be denied. If the part in question is not related to the reason your XTV fails to meet the standards, your claim will not be denied.

Emissions Warranty Coverage:

This warranty begins on the date the XTV is delivered to the first purchaser, or the date it is first used as a demonstrator, lease, or company XTV, whichever comes first and continues for the time and mileage listed below:

Time 30 months
Mileage 2,500 kilometers (1,550 miles)

Warranted Parts:

Fuel Tank
Fuel Cap
Fuel Line
Fuel Line Fittings
Clamps*
Carburetor
Press. Relief Valves*
Control Valves*
Control Solenoids*
Electronic Controls*
Control Cables*
Control Linkages*
Purge Valves
Vapor Hoses
Liq/Vapor Separator
Air Intake System
Press Relief Fittings*
Vacuum Control Diaphragms*
Engine
Engine Electronic Control Module*
Ignition System*
Sensors*
Exhaust System and Components
Spark Arrestor
Fuel Injection System and Components

*Components that are part of the engine, fuel injection system, fuel evaporative system and emissions control system.

Maintenance Record

MAINTENANCE INTERVAL	DATE OF SERVICE	MILEAGE	SERVICING DEALER NAME AND ADDRESS	REMARKS
1 Month				
3 Months				
6 Months				
12 Months				
18 Months				
24 Months				
30 Months				
36 Months				
42 Months				
48 Months				
54 Months				
60 Months				